

Gerard L. Hasenhuettl
Richard W. Hartel
Editors

Food Emulsifiers and Their Applications

SECOND EDITION



Springer

Food Emulsifiers and Their Applications

Second Edition

Gerard L. Hasenhuettl • Richard W. Hartel
Editors

Food Emulsifiers and Their Applications

Second Edition

 Springer

Dr. Gerard L. Hasenhuettl
2372 SE Stargrass Street
Port Saint Lucie, FL 34984
USA
Email: rabbithut@bellsouth.net

Prof. Richard W. Hartel
University of Wisconsin
1605 Linden Dr.
Madison, WI 53706
USA
Email: rwhartel@wisc.edu

ISBN: 978-0-387-75283-9 e-ISBN: 978-0-387-75284-6
DOI: 10.1007/978-0-387-75284-6

Library of Congress Control Number: 2008922727

© 2008 Springer Science+Business Media, LLC

All rights reserved. This work may not be translated or copied in whole or in part without the written permission of the publisher (Springer Science+Business Media, LLC, 233 Spring Street, New York, NY 10013, USA), except for brief excerpts in connection with reviews or scholarly analysis. Use in connection with any form of information storage and retrieval, electronic adaptation, computer software, or by similar or dissimilar methodology now known or hereafter developed is forbidden.

The use in this publication of trade names, trademarks, service marks, and similar terms, even if they are not identified as such, is not to be taken as an expression of opinion as to whether or not they are subject to proprietary rights.

Printed on acid-free paper

9 8 7 6 5 4 3 2 1

springer.com

To our wives and children, whose continued patience and understanding are greatly appreciated.

A special dedication is made to Niels Krog and Kare Larsson to recognize their valuable contributions to food emulsifier technology.

Preface

Emulsifiers have traditionally been described as ingredients that assist in formation and stabilization of emulsions. The definition, however, may be expanded to include mixing of mutually insoluble phases. Foams (gas in liquid or solid) and dispersions (solids in liquids or other solids) may be stabilized by emulsifiers. For this reason, the terms emulsifier and surfactant are used interchangeably.

The first emulsifiers were naturally occurring surface-active proteins, such as egg or casein. With advances in chemical and engineering technologies, the array of emulsifiers has been greatly expanded. Applications to food products have enabled the widespread distribution of packaged foods. Selection and design of emulsifiers was done by experienced product developers who were familiar with the behavior and interactions of each emulsifier. Over the past few decades, tremendous progress has been accomplished in the fundamental understanding of emulsions, dispersions and foams.

This book has focused on the design and application of emulsifiers as versatile food ingredients. The second edition has updated and expanded applications, from both theoretical and practical perspectives. The first three chapters describe design, synthesis, analysis, and commercial preparation of emulsifiers. Synergistic and antagonistic interactions with other food ingredients, such as carbohydrates, proteins, and water, are discussed in the next three chapters. The remainder of the book provides detailed descriptions of food product categories and quality benefits obtained by emulsifier systems. Dairy, infant nutrition, bakery, confectionery, and margarine products are included. Chapters on nutrition improvement (e.g., fat reduction) and processing techniques have been included.

Innovation in the food industry is progressing rapidly in response to economic, demographic, nutritional, and regulatory pressures. Many third world countries are undergoing dramatic economic development. This could stimulate demand for convenient packaged food products. At the same time, a contrarian trend toward natural, minimally processed foods is occurring in developed countries. An aging population has created a demand for functional foods. Some products (e.g., yogurt) are delivery vehicles for therapeutic agents. Global trade has stimulated calls for uniform safety and nutrition regulations. Food emulsifiers are versatile ingredients that may be valuable tools to address these challenges.

G.L. Hasenhuettl
R.W. Hartel

Contents

Chapter 1	Overview of Food Emulsifiers	1
	Gerard L. Hasenhuettl	
	1.1 Introduction.....	1
	1.2 Emulsifiers as Food Additives	2
	1.3 Emulsifier Structure.....	4
	1.4 Surface Active Hydrocolloids.....	7
	1.5 Emulsifier Functionality	7
Chapter 2	Synthesis and Commercial Preparation of Food Emulsifiers	11
	Gerard L. Hasenhuettl	
	2.1 Functional Group Design Principles.....	11
	2.2 Mono- and Diacylglycerols (Mono- and Diglycerides).....	14
	2.3 Propylene Glycol Esters of Fatty Acids.....	16
	2.4 Polyglycerol Esters of Fatty Acids	17
	2.5 Sorbitan Monostearate and Tristearate	18
	2.6 Sucrose Esters.....	19
	2.7 Sodium and Calcium Stearoyl Lactylate	21
	2.8 Derivatives of Monoacylglycerols	21
	2.9 Polyoxyethylene Derivatives	25
	2.10 Modification of Naturally Occurring Species.....	26
	2.11 Commercial Preparation of Food Surfactants.....	30
Chapter 3	Analysis of Food Emulsifiers	39
	Gerard L. Hasenhuettl	
	3.1 Thin Layer and Column Chromatography.....	40
	3.2 Wet Chemical Analysis.....	41
	3.3 Measurement of Physical Properties	48
	3.4 Instrumental Methods of Analysis.....	50
	3.5 Setting Specifications	57

Chapter 4	Emulsifier-Carbohydrate Interactions.....	63
	Gerard L. Hasenhuettl	
	4.1 Interactions with Simple Saccharides.....	63
	4.2 Starch/Surfactant Complexes.....	64
	4.3 Effect of External Lipids on Starch Properties	65
	4.4 Lipid Adjunct and Surfactant Properties	74
	4.5 Physical Properties of Starch/Surfactant Complexes.....	76
	4.6 Surfactant/Hydrocolloid Interactions.....	81
	4.7 Summary.....	83
Chapter 5	Protein/Emulsifier Interactions	89
	Tommy Nylander, Thomas Arnebrant, Martin Bos, and Peter Wilde	
	5.1 Introduction.....	89
	5.2 Properties of Proteins and Emulsifiers.....	90
	5.3 Protein/Emulsifier Interaction in Solution.....	97
	5.4 Interaction between Protein and Surfactants or Polar Lipids at Interfaces	114
	5.5 Applications.....	144
	5.6 Conclusion	156
Chapter 6	Physicochemical Aspects of an Emulsifier Functionality	173
	Björn Bergenståhl	
	6.1 Introduction.....	173
	6.2 Surface Activity	173
	6.3 Solution Properties of Emulsifiers.....	175
	6.4 The Use of Phase Diagrams to Understand Emulsifier Properties	177
	6.5 Examples of the Relation between Phase Diagrams and Emulsion Stability	179
	6.6 Some Ways to Classify Emulsifiers.....	185
	6.7 The Emulsifier Surface	190
Chapter 7	Emulsifiers in Dairy Products and Dairy Substitutes.....	195
	Stephen R. Euston	
	7.1 Introduction.....	195
	7.2 Ice Cream.....	196
	7.3 Whipped Cream and Whipping Cream.....	204
	7.4 Whipped Toppings.....	207
	7.5 Cream Liqueurs	210
	7.6 Creams and Coffee Whiteners	213

7.7	Cheese, Processed Cheese and Cheese Products.....	215
7.8	Recombined, Concentrated, and Evaporated Milks and Dairy Protein-Based Emulsions.....	219
7.9	Other Dairy Applications of Emulsifiers.....	223
7.10	Summary.....	224
Chapter 8	Emulsifiers in Infant Nutritional Products.....	233
	Séamus L. McSweeney	
8.1	Introduction.....	233
8.2	Types of Infant Nutritional Products	233
8.3	Emulsion Formation and Stabilisation.....	235
8.4	Emulsifying Ingredients in Infant Nutritional Products.....	238
8.5	Stabilising Agents Used in Infant Nutritional Products.....	241
8.6	Emulsifier Functionality in Infant Nutritional Products.....	241
8.7	Summary.....	255
Chapter 9	Applications of Emulsifiers in Baked Foods.....	263
	Frank Orthoefer	
9.1	Introduction.....	263
9.2	History of Bakery Emulsifiers	263
9.3	Definition of Emulsifiers	264
9.4	Emulsifier Function in Baked Goods.....	265
9.5	Role of the Shortening.....	267
9.6	Role of the Emulsifier.....	268
9.7	Emulsifier Interaction with Bakery Components	272
9.8	Applications in Baked Goods	276
9.9	Summary.....	283
Chapter 10	Emulsifiers in Confectionery	285
	Mark Weyland and Richard Hartel	
10.1	Introduction.....	285
10.2	Emulsifiers in Chocolate and Compound Coatings.....	286
10.3	Anti-Bloom Agents in Chocolate and Compound Coatings.....	295
10.4	Other Emulsifiers Used in Coatings	298
10.5	Emulsifiers in Non-Chocolate Confectionery.....	299
10.6	Chewing Gum	300
10.7	Processing Aids	303
10.8	Summary.....	304

Chapter 11	Margarines and Spreads	307
	Niall Young and Paul Wassell	
	11.1 Introduction.....	307
	11.2 The Rise of Margarine	308
	11.3 Terms and Terminology	309
	11.4 Building Blocks and Structure.....	310
	11.5 Emulsifiers	317
	11.6 Industrial Cake and Cream Margarine.....	318
	11.7 Puff Pastry Margarine	320
	11.8 Industrial Fillings.....	321
	11.9 Reduced- Low-Fat Spreads.....	321
	11.10 Product Spoilage.....	323
	11.11 Summary.....	325
Chapter 12	Application of Emulsifiers to Reduce Fat and Enhance Nutritional Quality	327
	Matt Golding and Eddie Pelan	
	12.1 Introduction.....	327
	12.2 Homogenised Dairy and Non-Dairy Whipping Creams	328
	12.3 Reduced and Low Fat Ice Cream.....	333
	12.4 Zero Fat Ice Cream	339
	12.5 Margarine.....	341
Chapter 13	Guidelines for Processing Emulsion-Based Foods.....	349
	Ganesan Narsimhan and Zebin Wang	
	13.1 Introduction.....	349
	13.2 Emulsification Equipment	350
	13.3 Droplet Phenomena	354
	13.4 Example of Emulsion Based Food Products.....	387
	13.5 Guidelines for Selection of Food Emulsifiers.....	389
Chapter 14	Forecasting the Future of Food Emulsifiers	395
	Gerard L. Hasenhuettl	
	14.1 Globalization of the Food Industry.....	395
	14.2 Nutritionally Driven Changes in Foods	396
	14.3 Advances in Science and Technology.....	398
	14.4 Design, Synthesis, and Commercial Preparation.....	400
	14.5 Applications at the Frontiers.....	400
Index.....		403

Contributors

Thomas Arnebrant

Biomedical laboratory science, Health and society, Malmö University,
SE-205 06 Malmö, Thomas.Arnebrant@hs.mah.se

Björn Bergenståhl

Food Technology Center for Chemistry and Chemical Engineering, Lund
University, S221 00 Lund, Sweden, Bjorn.Bergensstahl@livstecki.lib.se

Martin A. Bos

Manager Toxicology & Applied Pharmacology Department, Business Unit Quality
& Safety, TNO Quality of Life, Utrechtseweg 48, P.O. Box 360, 3700 AJ Zeist,
The Netherlands, martin.bos@tno.nl

Stephen R. Euston

School of Life Sciences, Heriot-Watt University, Edinburgh EH144AS,
UK, S.R.Euston@hw.ac.uk

Matt Golding

Material Science Discipline Leader, Food Science Australia, 671 Sneydes Road,
Werribee, Victoria 3030

Rich Hartel

University of Wisconsin, 1605 Linden Dr, Madison, WI 53706, USA,
rwhartel@wisc.edu

Gerard L. Hasenhuettl

2372 SE Stargrass St., Port St. Lucie, FL 34984, USA, rabbithut@bellsoith.net

Séamus L. McSweeney

Wyeth Nutrition, Inc., Milton, VT 05468, USA, SWEENESL@wyeth.com

Ganesan Narsimhan

Department of Agricultural and Biological Engineering, Purdue University,
West Lafayette, IN 47907, USA, narsimha@purdue.edu

Tommy Nylander

Physical Chemistry 1, Center for Chemistry and Chemical Engineering, Lund
University, 221 00 Lund, Sweden, Tommy.Nylander@fkem1.lu.se

Frank Orthofer

9146 Gorge Hollow Lane, Germantown, TN 38139, USA, forthofer@cs.com

Eddie Pelan

Unilever Food and Health Research Institute, Olivier van Noortlaan
120, Vlaardingen, 3130-AB, The Netherlands, Eddie.Pelan@unilever.com

Zebin Wang

Department of Agricultural and Biological Engineering, Purdue University,
West Lafayette, IN 47907, USA

Paul Wassell

Senior Application Specialist, Danisco (UK) Ltd., 1440 Montagu Court,
Kettering Parkway, NN15 6XR Kettering, Northamptonshire, U.K.,
paul.wassell@danisco.com

Mark Weyland

Loders Croklaan, 24708 W Durkee Road, Channahon IL, 815 730 5200,
mark_weyland@croklaan.com

Peter Wilde

Food Materials Science Division, Institute of Food Research, Norwich Research
Park, Norwich NR4 7UA. UK, Peter.Wilde@bbsrc.ac.uk

Niall Young

Food Protection Multiple Food Applications, Danisco A/S, Denmark,
niall.young@danisco.com

Chapter 1

Overview of Food Emulsifiers

Gerard L. Hasenhuettl

1.1 Introduction

Food colloids, emulsions and foams have their origins in nature and have evolved with advances in food processing techniques. Milk, for example, has a naturally occurring membrane, which allows solid fat to be dispersed into an aqueous phase. Early food formulations for butter, cheese, whipped cream and ice cream took advantage of these natural emulsifiers. The invention of mayonnaise as a cold sauce in France utilizes egg lipoproteins and phospholipids to disperse oil into an acidified aqueous phase. The emulsifying power of these lipoproteins is still impressive by today's standards, because up to 80% oil could be dispersed without inversion to an oil continuous emulsion. In 1889, the French chemist Hippolyte Mege-Mouries invented margarine as a low-cost substitute for butter. An aqueous phase was dispersed into a molten tallow to form an oil continuous emulsion. Subsequent discovery of the hydrogenation process allowed the substitution of partially hydrogenated oil for the tallow. In this application, the emulsion only had to be stable long enough to solidify the fat and fill into containers.

Synthetic emulsifiers have only come into wide commercial use in the second half of the twentieth century. Their development was driven by the processed food industry, which needed shelf-stable products for distribution through mass-market channels. For example, creamy salad dressings may be stored for up to a year without visible separation. Other factors, such as rancidity, are now more important factors in predicting product stability.

Detailed knowledge of the physical chemistry of emulsions is best obtained when pure oil, water, and emulsifiers are used. Food emulsions, by contrast, are extraordinarily complex systems. Commercial fats and oils are rich mixtures of triacylglycerols that also contain small amounts of highly surface-active materials; Salt content and pH in food emulsions vary widely enough to have significant effects on their stability. Natural and commercial emulsifiers are often complex mixtures that vary in composition between different manufacturers. Other food ingredients, such as proteins and particulates, contribute surface activity that may dramatically alter the character of the emulsion. Processing conditions can affect emulsion stability. For example, high temperatures, with or without agitation, may be used for

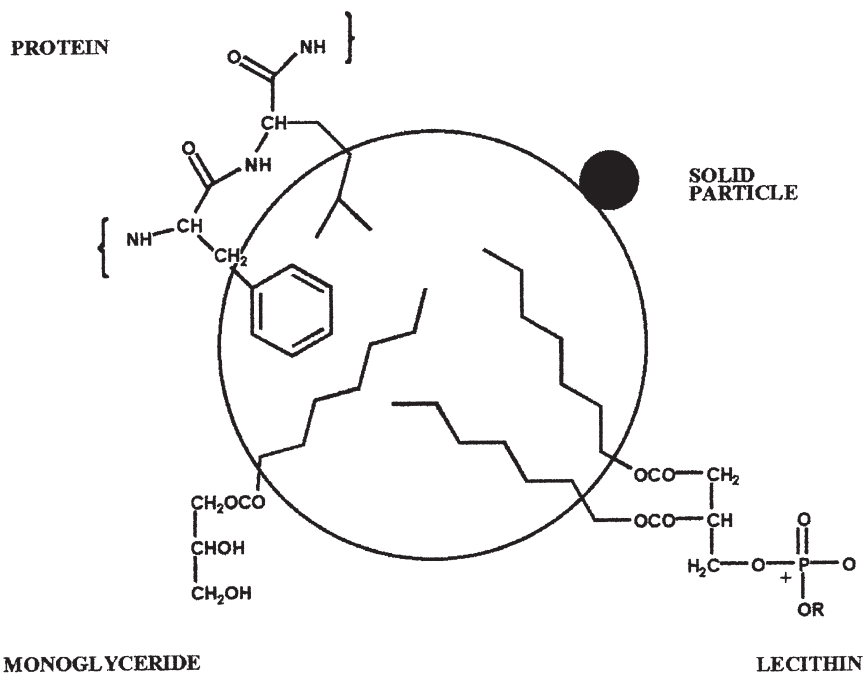

Fig. 1.1 Schematic representation of an Emulsified oil droplet

pasteurization. Because of all these complex relationships, the formulation of food emulsions grew up as an art, dominated by individuals having a great deal of experience. The gradual development of sophisticated techniques such as electron microscopy, rheology, nuclear magnetic resonance, and chromatography/mass spectrometry has solidified the art with a scientific dimension. The orientation of some typical food emulsifiers at the water/oil interface is displayed in Fig. 1.1.

The science of food emulsions has been extensively covered by other authors (Dickinson and Rodriguez-Patino, 1999; Friberg et al., 2003; McClements 2004). This book will concentrate on the structure, preparation, analysis, interactions, and applications of emulsifiers.

1.2 Emulsifiers as Food Additives

Approximately 500,000 metric tons of emulsifiers are produced and sold worldwide. Sales in the European Union and the United States are estimated to be 200–300 million EURO and 225–275 million USD respectively. However, since the value/volume ratio of these products is low and local regulations vary, very little truly global trade has yet developed. Products, which are solids at room temperature,

may be packaged as beads or flakes. Semisolids may be available in plastic lined cartons or drums. In some cases, bulk quantities may be delivered in tank trucks or rail cars.

In the United States, food emulsifiers, along with other additives, are regulated by the Food and Drug Administration (Federal Register, 2003). Two sections of the regulations govern their use: substances Affirmed as GRAS, that is, Generally Recognized as Safe, (21CFR184) and Direct Food Additives (21CFR172). Substances that have been affirmed as GRAS usually have less stringent regulations attached to their use. However, Food and Drug Administration Standards of Identity may preclude their use in certain standardized foods. In comparison, direct food additives may be allowed only in certain specific foods at low maximum allowable levels. The method of manufacture and analytical constants may also be defined. Tables 1.1 and 1.2 reference Food and Drug regulations.

Table 1.1 Food emulsifiers affirmed as GRAS

Emulsifier	U.S. FDA (21CFR)	EEC (E No.)
Diacetyltartaric esters of monoglycerides (DATEM)	184.1101	E472e
Lecithin	184.1400	E322
Mono- and diglycerides	184.1505	E471
Monosodium phosphate derivatives of mono and diglycerides	184.1521	–

Table 1.2 Emulsifiers—Direct food additives

Emulsifier	U.S. FDA (21CFR)	EEC (E No.)
Acetylated mono- and diglycerides	172.828	E472a
Calcium stearoyl lactylate	172.844	E482
Citric acid esters of mono- and diglycerides	172.832	E472c
Ethoxylated mono- and diglycerides	172.834	–
Lactic acid esters of mono- and diglycerides	172.850	E472b
Magnesium salts of fatty acids	172.863	E470b
Polyglycerol polyricinoleate	–	E476
Polysorbate 60	172.836	–
Polysorbate 65	172.838	–
Polysorbate 80	172.840	–
Propylene glycol esters of fatty acids	172.856	E477
Salts of fatty acids	172.863	E470a
Sodium stearoyl lactylate	172.846	E481
Sodium stearoyl fumarate	172.826	–
Sorbitan monolaurate	–	E493
Sorbitan monooleate	–	E494
Sorbitan monopalmitate	–	E495
Sorbitan monostearate	172.842	E491
Sorbitan tristearate	–	E492
Stearyl tartrate	–	E483
Succinylated mono- and diglycerides	172.830	–
Sucrose acetate isobutyrate (SAIB)	172.833	–
Sucrose esters of fatty acids	172.859	E473
Tartaric acid esters of mono- and diglycerides	–	E472d

The European Economic Community (EEC) regulates food emulsifiers in an analogous fashion to United States regulations. E-numbers are also listed in Tables 1.1 and 1.2. Specific regulations, however, must be consulted before food products are designed for international markets. For example, polyglycerol esters up to a degree of polymerization of 10 are widely accepted in the United States. For the EEC, this value may not exceed 4. Standards of identity may also differ significantly.

Other countries, which have not formed trading communities, may have regulations, which are unique. Careful translation from the local language is often difficult and time consuming.

As with any other totally new food additive, the need to prove safety of the product in foods at high levels of consumption requires extensive toxicity studies and enormous documentation. The consequent financial and time commitment make development of totally new synthetic emulsifiers unattractive for emulsifier manufacturers. A somewhat easier development approach is to petition for expanded use (new applications or higher permitted levels) of emulsifiers that are already approved. However, even this tactic may require several years of review. In addition to national regulations, many food processors require their ingredients, including food emulsifiers, to be Kosher so that their products are acceptable to Jewish and many Islamic consumers. For emulsifiers to be considered Kosher, they must be produced from Kosher-certified raw materials. This requirement precludes the use of almost all animal fats. This is not much of a problem since emulsifiers are easily produced from vegetable fats that can be blended to give similar fatty acid compositions. The major concern in Kosher certification is to determine in advance whether the customer's rabbinical council recognizes the Hekhsher (Kosher symbol) of the producer's rabbi.

Products labeled, as "all natural" must contain ingredients that have not been chemically processed or modified. Only lecithin or other naturally occurring materials such as proteins and gums, would be acceptable for these products.

1.3 Emulsifier Structure

Since food emulsifiers do more than simply stabilize emulsions, they are more accurately termed surfactants. However, because the term emulsifier has been used so extensively in the food industry, both terms will be used interchangeably in this book. Surface-active compounds operate through a hydrophilic head group that is attracted to the aqueous phase, and an often-larger lipophilic tail that prefers to be in the oil phase. The surfactant therefore positions itself to some extent, at the air/water or oil/water interface where it can act to lower surface or interfacial tension, respectively. Lipophilic tails are composed of C16 (palmitic) or longer fatty acids. Shorter chains, such as C12 (lauric), even though they can be excellent emulsifiers, can hydrolyze to give soapy or other undesirable flavors. Unsaturated fatty acids are molecules having one (oleic) or two (linoleic) *cis* (Z) double bonds. Linoleic acid is usually avoided since it is easily oxidized and may produce an oxidized rancid off-flavor in the finished food. Fats may be hydrogenated to produce a mixture of

saturated and unsaturated fatty acids. Emulsifiers produced from these fatty acids may have an intermediate consistency (often referred to as “plastic”) between liquid and solid. These products also contain measurable concentrations of trans (E) unsaturated fatty acids that have higher melting points than the cis (Z) fatty acids.

Polar head groups may be present in a variety of functional groups. They may be incorporated to produce anionic, cationic, amphoteric, or nonionic surfactants. Mono- and diacylglycerols (more commonly known as mono- and diglycerides), which contain an -OH functional group, are the most widely used nonionic emulsifiers. Sodium stearyl lactylate is an anionic surfactant used widely in bakery products. Lecithin, whose head group is a mixture of phosphatides, may be visualized as amphoteric or cationic, depending on the pH of the product.

Proteins may also be surface active due to the occurrence of lipophilic amino acids such as phenylalanine, leucine, and isoleucine. Interfacially active proteins will fold so that lipophilic groups penetrate into the oil droplet while hydrophilic portions of the chain extend into the aqueous phase. Proteins in this configuration may produce a looped structure that provides steric hindrance to oil droplet flocculation and coalescence. Charged proteins may also stabilize emulsions due to repulsion of like charged droplets. Proteins may also destabilize water-in-oil emulsions, such as reduced fat margarines, by causing the emulsion to invert.

Food emulsifiers may be thought of as designer molecules because the structure and number of heads and tails may be independently varied. A very useful conceptual tool is hydrophile-lipophile balance (HLB). The topic has been extensively reviewed by Becher (2001) so only a brief description will be presented here. The number and relative polarity of functional groups in a surface-active molecule determine whether the molecule will be water or oil soluble (or dispersible). This concept has been quantitated by calculation of an HLB value to describe a given emulsifier. High HLB values are associated with easy water dispensability. Since conventional practice is to disperse the surfactant into the continuous phase, high HLB emulsifiers are useful for preparing and stabilizing oil-in-water (O/W) emulsions. Low HLB emulsifiers are useful for formulation of water-in-oil (W/O) emulsions, such as margarine. Extreme high or low values are not functional as emulsifiers since almost all of the molecule will be solubilized in the continuous phase. They would, however, be very useful for full solubilization of another ingredient, such as a flavor oil or vitamin, in the continuous phase. At some intermediate values of HLB, the molecule may not be stable in either phase and will result in high concentration at the interface. The practice of adding surfactant to the continuous phase is known as Bancroft’s Rule. One notable exception is the formulation of creamy salad dressings by adding polysorbate 60, a high HLB emulsifier, to the oil phase.

Surfactants may assemble into organized structures described as mesophases or liquid crystals. These bilayer structures adopt several geometric forms: (1) Lamellar—sheets of bilayers where the hydrophilic groups are paired. Large amounts of water may be trapped in this mesophase, thereby reducing its concentration in the bulk phase. (2) Hexagonal—two cylindrical types. In Type I, the lipophilic tails are contained inside the cylinder and the hydrophilic groups are on the surface. For Type II, the geometry is reversed, with the lipophilic tails on the outside and hydrophilic groups inside the cylinder. (3) Vesicles (liposomes)—Spherical bilayer structures.

The most common are large unilamellar vesicles (LUV) and small unilamellar vesicles (SUV). These mesophases have received a good deal of attention in the science of drug delivery. (4) Cubic—Complex three-dimensional structures which are difficult to characterize.

Israelachvili (1992) has described a predictive model based on the critical packing coefficient. As shown in Fig. 1.2, packing into the mesophase structure is predicted based on the hydrodynamic radius of the head group and the number and effective length of the lipophilic tails. For example, a double tail surfactant with a small head group, like lecithin, can readily pack into a liposome. Predictions based on this model are summarized in Table 1.3.

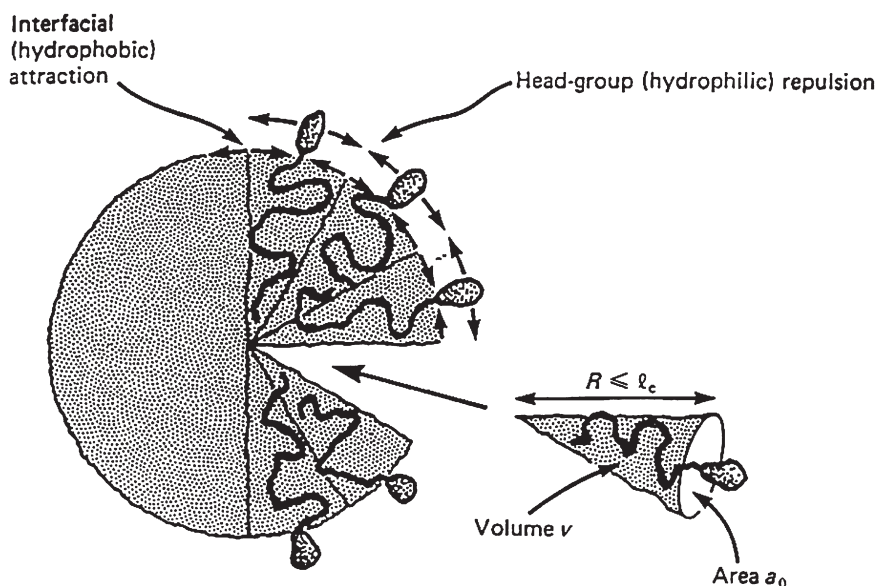

Fig. 1.2 Critical packing parameter for prediction of mesophase structure (Israelachvili, 1992, p. 368). Reproduced with permission of Elsevier Ltd

Table 1.3 Prediction of mesophase structure using critical packing parameters

Molecular structure	Packing parameter	Shape	Mesophase
Small single-tail lipid; Large polar head group	$<1/3$	Cone	Micelle
Single-tail lipid; Small polar head group	$1/3-1/2$	Truncated cone	Hexagonal
Double-tail lipid; Large polar head group	$1/2-1$	Truncated cone	Vesicle
Double-tail lipid; Small polar head group	~ 1	Cylinder	Lamellar
Double-tail lipid; Small polar head group	>1	Inverted truncated cone	Inverted micelle

Adapted from Israelachvili (1992, p. 381).

1.4 Surface Active Hydrocolloids

Traditionally, hydrocolloids such as gums and starches have been regarded as thickeners. Their stabilizing effect on emulsions derives from an increase in viscosity of the aqueous phase. The kinetic motion of the droplets is reduced, resulting in a lower rate of flocculation and coalescence. Because of their relatively high oxygen/carbon ratio, these molecules are polar, with an affinity for the aqueous phase. In addition, some, such as sodium alginate, carry a negative charge, which enhances the hydrophilic character. Some commercial gums, however, contain surface-active proteins. As a result, these hydrocolloids demonstrate interfacial activity in some applications.

Starches and gums may be chemically or enzymatically modified to insert a lipophilic group. For example, alginic acid may be esterified with propylene glycol to yield propylene glycol alginate. The pendant methyl group can facilitate coupling with the oil phase. Saccharides, starches, and gums may interact with emulsifiers to produce enhanced functionality. This will be discussed further in Chap. 4.

1.5 Emulsifier Functionality

In addition to their major function of producing and stabilizing emulsions, food emulsifiers (or surfactants) contribute to numerous other functional roles, as shown in Table 1.4. Some foods, notably chocolate and peanut butter, are actually dispersions of solid particles in a continuous fat or oil phase. Chocolate viscosity is controlled by the addition of soy lecithin or polyglycerol ricinoleate (PGPR). Oil separation in peanut butter is prevented by use of a monoglyceride or high melting

Table 1.4 Functionality of surfactants in some foods

Functionality	Surfactant	Food example(s)
Foam aeration/stabilization	Propylene glycol esters	Cakes, whipped toppings
Dispersion stabilization	Mono/diglycerides	Peanut butter
Dough strengthening	DATEM	Bread, rolls
Starch complexation (anti-staling)	SSL, CSL	Bread, other baked goods
Clouding (weighting)	Polyglycerol esters, SAIB	Citrus beverages
Crystal inhibition	Polyglycerol esters, oxystearin	Salad oils
Antisticking	Lecithin	Candies, grill shortenings
Viscosity modification	Lecithin	Chocolate
Controlled fat agglomeration	Polysorbate 80, polyglycerol esters	Ice cream, whipped toppings
Freeze-thaw stabilization	SSL, polysorbate 60	Whipped toppings, coffee whiteners
Gloss enhancement	Sorbitan monostearate, polyglycerol esters	Confectionery coatings, canned and moist pet foods

fat. In some products, such as ice cream and whipped toppings, one of the dispersed phases is air. Foam stability is a critical functional property in these systems. In some cases the secondary effect may be of greater concern than formation of the emulsion. Strengthening of dough and retardation of staling are vital considerations to processors who bake bread.

A common practice in the food industry is to use two or three component emulsifier blends to achieve multiple functionalities. In a cake emulsion, for example, aeration to produce high volume, foam stabilization, softness, and moisture retention are achieved by using an emulsifier blend. One useful statistical method to optimize emulsifier blends is the full factorial experimental design using a zero or low level and a higher level of each ingredient. The major advantage of this design is that it will detect two and three factor interactions that are not uncommon in complex food systems. Response surface methodology (RSM) and fractional factorial designs are also very useful techniques because they reduce the number of experiments necessary to obtain optimal concentrations. Robust design is recommended for products that require the consumer to mix ingredients. This approach results in a quality product, even if measurements are slightly inaccurate.

Small molecule emulsifiers (e.g., monoglycerides) may exert their effect by partially or totally displacing proteins from an oil/water interface. This replacement is entropically favored because of the difference in size and mobility of the species. Direct interaction of emulsifiers and proteins may be visualized through electrostatic and hydrogen bonding, although it is difficult to observe in a system that contains appreciable amounts of oil. Chapter 5 on emulsifier/protein interactions will elaborate on these concepts.

Emulsifier suppliers generally employ knowledgeable technical service professionals to support their customer's product development efforts. Their experience in selecting emulsifiers for a functional response is a valuable initial source of information. However, food processors may want to develop unique products that have no close relationship to a product currently in commerce. In this case, the supplier may have some general ideas for emulsifier selection. However, it may be necessary for product developers to define their own criteria for emulsifiers based on critical functions required in the product.

The objective of this book is to provide the food industry professional or interested technical professional with an overview of what emulsifiers are, how they are prepared, and how they are utilized in food products. Although in many senses food emulsifiers have become commodity ingredients, sophisticated understanding and application in processed foods is likely to continue to advance.

References

- Becher, P. (2001). *Emulsions: Theory and Practice*, 3rd edition. Washington: American Chemical Society.
- Dickinson, E. and Rodriguez-Patino, J. M. (eds.) (1999). *Food Emulsions and Foams: Interfaces, Interactions and Stability*. Cambridge: Royal Society of Chemistry.

- Federal Register (2003). Food and drugs—Title 21. *Code of Federal Regulations*. (Parts 170–199) U. S. Government Printing Office: Washington.
- Friberg, S., Larsson, K., and Sjoblom, J. (eds.) (2003). *Food Emulsions*. New York: Food Science and Technology, Marcel Dekker.
- Israelachvili, J. (1992). Thermodynamic principles of self-assembly. In J. Israelachvili. (ed.), *Intermolecular and Surfaces* (pp. 341–394). London: Academic Press.
- McClements, D. J. (2004). *Food Emulsions: Principles, Practices and Techniques*. New York: CRC Press.

Chapter 2

Synthesis and Commercial Preparation of Food Emulsifiers

Gerard L. Hasenhuettl

2.1 Functional Group Design Principles

Food emulsifiers, more correctly referred to as surfactants, are molecules, which contain a nonpolar, and one or more polar regions. In general, nonpolar groups are aliphatic, alicyclic, or aromatic hydrocarbons. Polar functional groups contain heteroatoms such as oxygen, nitrogen, and sulfur. As shown in Fig. 2.1, the polar functionality makes the emulsifier anionic, cationic, amphoteric, or nonionic. Anionic surfactants contain a negative charge on the bulky molecule, associated with a small positive counterion. Cationics have a positively charged molecule with a negative counterion. Amphoteric surfactants contain both positive and negative charges on the same molecule. A nonionic surfactant contains no formal positive or negative charge, but a polar heteroatom produces a dipole with an electron dense and electron-depleted region.

Many food products use emulsifying agents present in the foods themselves. For example, casein and egg yolk proteins are excellent emulsifiers. Alanine, phenylalanine, leucine and isoleucine contain nonpolar aliphatic and aromatic side chains. Amino acids, such as arginine, lysine and tryptophane, contain amino groups, which promote cationic character to the protein. Aspartic and glutamic acids possess side chains with carboxyl groups, which contribute to anionic character. The nature, number and location of the polar amino acids determine the isoelectric point of a protein; e.g., the pH at which the protein is uncharged. In food systems where the pH is above the isoelectric point, the protein will behave as an anionic emulsifier, while at pH values below their isoelectric point, it will become cationic. One complicating factor in using emulsifiers is that their charge makes them vulnerable to interactions with other charged species, such as calcium ions and some gums. In addition, proteins may denature under some processing conditions, such as high temperature and shear forces.

Phospholipids from egg and soy have found many applications in food products. Structurally, these molecules contain two fatty acids esterified to glycerol and a phosphatidyl group esterified to a terminal -OH group on the glycerol. Phosphatidylcholine (PC), phosphatidylethanolamine (PE), Phosphatidylinositol (PI), and phosphatidylserine (PS) are the predominant polar functional groups.

TYPES OF SURFACTANT STRUCTURES



ANIONIC

Negative charge on surfactant

Small positive counterion

AMPHOTERIC

Both positive negative charges on surfactant



CATIONIC



NONIONIC

Fig. 2.1 Structures of anionic, cationic, amphoteric, and nonionic surfactants

Egg and soy lecithins differ significantly in their molecular structures. There are significant differences in PC, PE, PI, and PS distributions. Fatty acid chains in soy lecithin are predominately unsaturated. In contrast, alkyl chains are more saturated.

Egg and soy lecithins may be purified and/or modified to improve their properties. Egg lecithin has been studied in the pharmaceutical industry, but purification is much too costly for the food industry. Soy lecithin may be separated from residual triacylglycerols by precipitation. This process yields an emulsifier with a higher HLB value. HLB may also be realized by treatment with Phospholipase A₂ to remove one of the fatty acids. Currently, this process is expensive and the product has not received regulatory approval for use in foods. Reaction with peroxides has also been used to increase the polar character of lecithin.

Many synthetic emulsifiers have been used in the food industry without evidence of harmful effects. Their chemistry is derived from over 150 years of chemical manipulation of fats and oils (Polouze and Gelis, 1844). They have been designed to contain naturally occurring molecules or in the case of non-naturally occurring molecules, to pass through the body without being metabolized. For example, cleavage of polyglycerol esters results in a fatty acid, which is metabolized, and a polyglycerol backbone, which passes through the digestive system without being absorbed.

As shown in Fig. 2.2, lipophilic functional groups are derived from naturally occurring fatty acids approved for food use by the FDA. Saturated fatty acids contain 16–22 carbon atoms. Fatty acids shorter than 14 carbons, although they are excellent emulsifiers, result in soapy or other off-flavors in the finished food

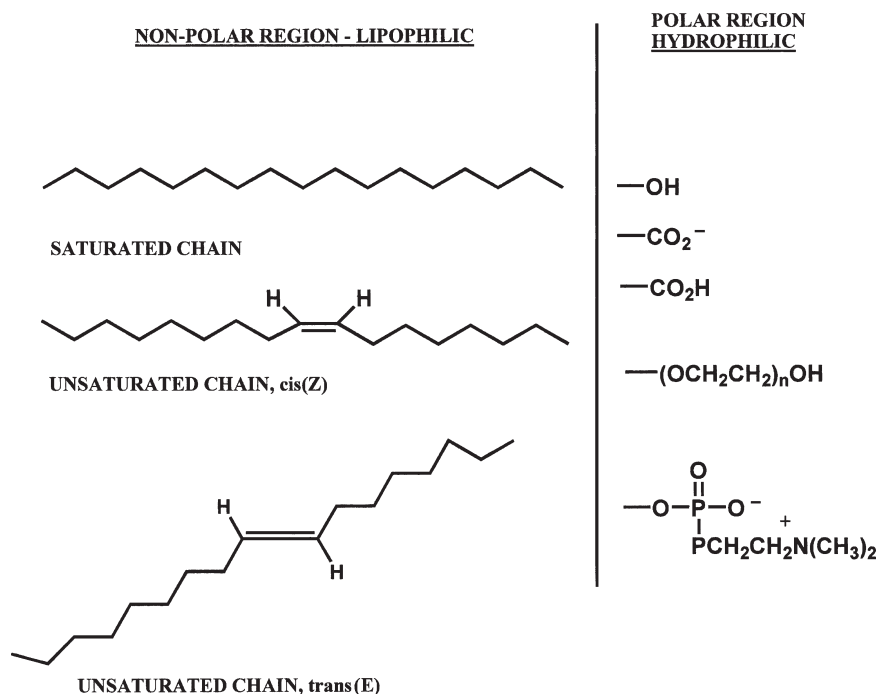

Fig. 2.2 Polar and nonpolar functional groups

product. Unsaturated fatty acids, used as starting materials for food emulsifiers, containing a single double bond. Multiple double bonds would produce an oxidized rancid off-flavor. Trans (E) double bonds result from nickel-catalyzed hydrogenation of unsaturated oils. Based on the model (Israelachvili, 1992), discussed in Chap. 1, *cis* (Z) double bond chains would be predicted to pack differently than *trans* (E) chains. Therefore, there may be a difference in emulsifier functionality, depending on whether the starting fat or fatty acid was obtained through hydrogenation or blending.

Polar head groups in food emulsifiers contain oxygen, nitrogen and phosphorus as electronegative heteroatoms. The hydroxyl group is predominant in many nonionic emulsifiers, such as mono- and diacylglycerols, propylene glycol, sorbitan, sucrose and polyglycerol esters of fatty acids. Monoacylglycerols may be esterified with acetic or lactic acid to yield anionic emulsifiers with modified functionalities. Polycarboxylic acids may be reacted with monoacylglycerols to give potential anionic surfactants. Examples are succinate, citrate and diacetyltartarate esters of monoacylglycerols. Fatty acids may be reacted with lactic acid and alkali to produce sodium or calcium stearoyl lactylate. Polyoxyethylene chains may be introduced into sorbitan esters or monoacylglycerols to increase the hydrophilic character of the molecule.

Although many new organic reactions have been developed in other fields, the regulatory difficulties faced by new surface-active molecules are enormous. Current research has focused on enzyme catalyzed reactions and biological modification of starting materials.

2.2 Mono- and Diacylglycerols (Mono- and Diglycerides)

Mono- and diacylglycerols are the most widely used synthetic emulsifiers in the food industry. They are present in small quantities in natural fats and oils as a result of hydrolysis, which also releases fatty acids. Monoacylglycerols, which contain two free hydroxyl groups, exhibit stronger surface activity than diacylglycerols.

In the laboratory, monoacylglycerols may be prepared by reaction of a fatty acyl chloride with glycerol in the presence of pyridine, which acts both as a solvent and an organic base. However, the corrosivity of acyl chlorides and the toxicity of pyridine are problematic for commercial application of this approach. For example, the isopropylidene (acetonide) protective group can block the 1 and 2 positions of glycerol while esterification can be performed on the 3-position (Heidt et al., 1996). Glycidol, an epoxide derivative of glycerol, may also be used as a starting material to produce pure monoacylglycerols (Tamura and Suginuma, 1991). Diacylglycerols may be used as intermediates in the synthesis of regioselective and chiral triacylglycerols and Phospholipids (Dong et al., 1982).

The two most prevalent commercial preparations of mono- and diacylglycerols are (1) Direct esterification of glycerol with a fatty acid, and (2) Glycerolysis of natural or hydrogenated fats and or oils. As shown in Fig. 2.3, both processes yield approximately the same equilibrium distribution of mono- di- and triacylglycerols. The glycerolysis procedure is more economical because fats are cheaper than fatty acids and less glycerol is required. Fats and fatty acids are insoluble in glycerol and, in the absence of solvent; elevated temperatures are required to force the reaction to proceed.

Direct esterification may be catalyzed either by acids or bases. The ratio of glycerol to fatty acid determines the concentrations of mono-, di- and triacylglycerols in the final product. Higher levels of glycerol produce higher concentrations of monoacylglycerols. In a typical batch procedure, fatty acid, glycerol and catalyst

DIRECT ESTERIFICATION:

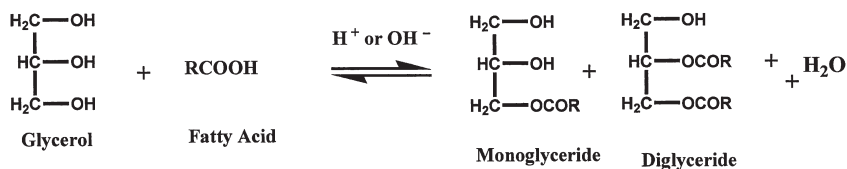

INTERESTERIFICATION:

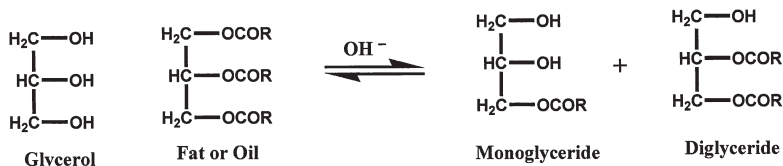

Fig. 2.3 Monoacylglycerol synthesis through direct esterification and interesterification

are stirred at 210–230 °C. Water is continuously removed by distillation, causing the equilibrium to shift toward products. Progress of the reaction is monitored by periodic measurement of the acid value (see Chap. 3). Figure 2.4 shows the linear decrease in the log of the acid value vs. time. Early values on this plot may be extrapolated to predict the reaction end point. When the reaction is complete, the catalyst is neutralized to stop equilibration, and excess glycerol is removed by distillation at reduced pressure. Neutralization is more critical when batch distillation is used than for rapid short path/ short time processes.

For interesterification (glycerolysis), fat, glycerol and alkaline catalyst, such as calcium hydroxides are stirred at high temperature. Higher glycerol/fat ratios require higher reaction temperatures to force the reaction to completion. Recently, a process has been described in which the partial glycerol esters are introduced into the initial reaction mixture to promote homogeneity and increase the rate of the reaction (Sigfried and Eckhard, 2005). The end point of the reaction is determined visually. A sample taken from the reactor is clear. As with direct esterification, the catalyst is neutralized and excess glycerol is removed.

Since these reactions are carried out at high temperatures, side reactions can produce dark colors and off flavors, which can be a problem in a finished food product. Use of an inert atmosphere, such as nitrogen, in the reaction vessel reduces oxidative side reactions. Calcium hydroxide at 0.01–0.035% yields a product with good color. One problem arises when the catalyst is neutralized with phosphoric acid. The calcium phosphate is a fine precipitate that may be difficult to remove with some older filters. Use of a low-iron sodium hydroxide, e.g., rayon grade, may produce products with lighter colors than conventional food grade material.

Some recent investigations have described enzyme-catalyzed esterification as an attractive method for synthesis of monoacylglycerols (Waldinger and Schneider,

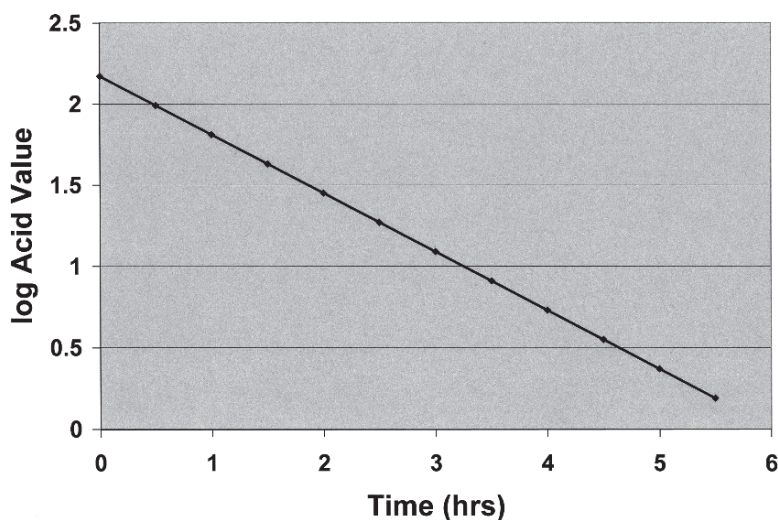

Fig. 2.4 Measurement of direct esterification using acid value

1996; Hari-Krishna and Karanth, 2002; Montiero et al., 2003). Lipase is an enzyme, which breaks down fats into sn-2 monoacylglycerols and fatty acids. Used in reverse, it can catalyze the esterification of glycerol with fatty acids. The ambient to moderate temperatures used in this process minimize the potential side reactions and may allow the preparation of sn-1 monoacylglycerols. Potential problems with the process are high cost and denaturation of the enzyme as well as slow reaction times.

Products having α -monoglyceride concentrations (see Chap. 3) of 10–55% may be produced by esterification and interesterification by adjusting the glycerol/fatty acid ratio. Monoacylglycerols may be further purified by short path distillation. Monoglyceride levels >90% may be produced. Monoacylglycerols may be liquid, solid, or semi-solid (also referred to as “plastic”). Solids may be flaked or spray-chilled into beads. Liquids are shipped in bulk or in metal drums or pails. Semisolids are packed into plastic-lined drums or cartons.

2.3 Propylene Glycol Esters of Fatty Acids

Propylene glycol is similar in structure to glycerol. It is a three-carbon chain but one terminal position does not bear a hydroxyl group. This structural difference causes a shift in physical properties. The boiling point of propylene glycol is lower and its oil solubility is greater than that of glycerol. The impact of these differences is that the temperature required for reaction is lower.

Synthetic processes for producing propylene glycol esters are similar to those used for monoacylglycerols. Figure 2.5 shows direct esterification and interesterification reactions. However in contrast to monoacylglycerols, interesterification produces a more complex mixture than direct esterification. Mono- di- and triacylglycerols are also reaction products of the latter process. Differences in functionality may be expected between products derived from the two processes. As with monoacylglycerol synthesis, the interesterification route is more economical.

Direct esterification is conducted by reacting fatty acids with propylene glycol in the presence of an acid or alkaline catalyst. As with monoacylglycerol synthesis, progress of the reaction may be monitored by the decrease in acid value. After completion, the catalyst is neutralized and excess propylene glycol is separated by fractional distillation at reduced pressure. Although fatty acids are more expensive than fats, esterification does enjoy limited use in the food industry where product color or specific functionality is critical.

Heating propylene glycol, fat and an alkaline catalyst carries out interesterification. The reaction mixture must be dry because water inhibits the onset of reaction. As with monoacylglycerols, completion of the reaction is detected by observation of homogeneity. The concentration of propylene glycol monoester may be controlled by the ratio of the starting materials and measured by gas-liquid chromatography (see Chap. 3).

Since there is only one primary alcohol group in propylene glycol, as compared to two in glycerol, regioselective lipase enzyme-catalyzed esterification should produce high yields of propylene glycol monoester.

DIRECT ESTERIFICATION:**INTERESTERIFICATION:**

Fig. 2.5 Preparation of propylene glycol monoesters by direct esterification and interesterification

2.4 Polyglycerol Esters of Fatty Acids

Oligomerization and subsequent esterification with fatty acid allows the emulsifier designer to increase the size of the hydrophilic head group. The hydrophile–lipophile balance and mean molecular weight are controlled by the degree of glycerol polymerization and the fatty acid/polyglycerol ratio. These factors along with the nature of the fatty acid determine whether the product is solid, liquid, or semisolid.

In the first step of this synthesis, shown in Fig. 2.6, glycerol is heated to high temperatures in the presence of an acidic or alkaline catalyst under an inert atmosphere. Free hydroxyl groups condense to eliminate water and form ether linkages. Condensation may be intermolecular to produce linear oligomers, or intramolecular to give cyclic species. Lower reaction temperatures and lower pH favor cyclic isomers. When sodium hydroxide is used as the catalyst, pH declines as the reaction progresses. Side reactions occur at high temperatures to produce dark colors and off-flavors and objectionable odors. Recently, processes have been developed using mesoporous (Charles et al., 2003) and zeolite (Esbuis et al., 1994) catalysts under milder conditions. Progress of the reaction may be monitored by refractive index, near-infrared reflectance, or hydroxyl value (see Chap. 3). In addition, the reaction mixture increases in viscosity as the degree of polymerization increases. Polyglycerols for the food industry have an average degree of polymerization from diglycerol to decaglycerol. Polyol distribution may be measured by converting a sample to trimethylsilyl ethers followed by gas-liquid chromatography (Sahasrabudde, 1967; Schuetze,

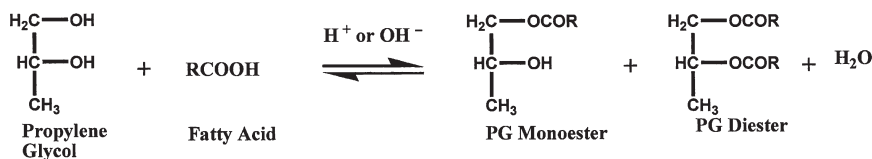
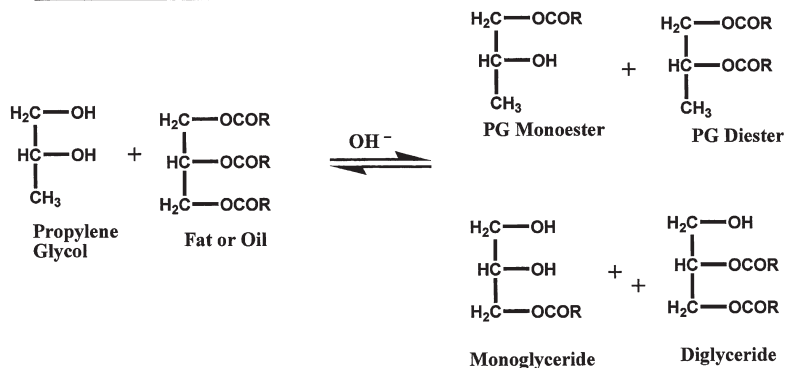
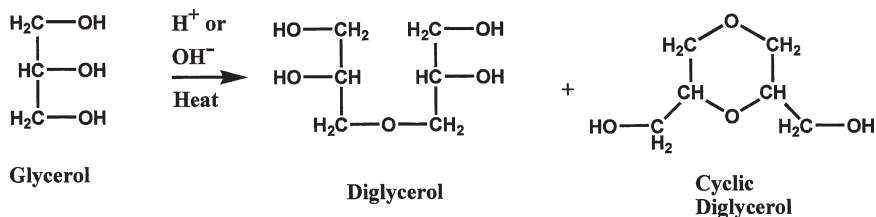

Fig. 2.6 Polymerization of glycerol

1977). Polyglycerol may be used as produced, or may be stripped of excess glycerol and cyclic diglycerol by steam distillation at reduced pressure (Aoi, 1995).

Either direct esterification with fatty acids or interesterification with fats or oils may be used to produce polyglycerol esters. For polyols with higher degrees of esterification, fatty acids are used to prevent introduction of glycerol into the distribution. Interesterification can be used for lower degrees of polymerization, which have been stripped of glycerol and cyclic diglycerol. The degree of esterification and HLB are controlled by the ratio of fatty acid to polyglycerol in the reaction mixture. Some selectivity in the esterification has been reported by control of reaction temperature (Kasori et al., 1995). High reaction temperatures are associated with undesirable side reactions. A lower temperature process using a solid catalyst has been described (Marquez-Alvarez et al., 2004). Monoesters may be prepared by using an isopropylidene protecting group (Jakobson et al., 1989) or by enzymatic transesterification with lipase (Charlemange and Legoy, 1995).

A unique emulsifier may be produced by reaction of polyglycerol with the bifunctional ricinoleic acid, the predominant component in castor oil. The carboxyl group of ricinoleic acid may react with a hydroxyl group on a polyglycerol or with a hydroxyl on another ricinoleic acid. The composition of the reaction may be controlled by the order of addition (Aoi, 1995).

2.5 Sorbitan Monostearate and Tristearate

Despite its simple name, sorbitan monostearate is a complex mixture of molecules. Commercial stearic acid may have a range of 45–90% C-18:0, depending on its source. Cyclization/dehydration reactions produce a mixture of sorbitol, sorbitan, and isosorbide. The simultaneous esterification reaction yields a random distribution of monostearates through hexastearate. Sorbitan monostearate and tristearate are averages of their respective distributions.

A reaction mixture of stearic acid, sorbitol and a catalyst is heated under an inert atmosphere to cause simultaneous esterification and cyclization reactions as shown in Fig. 2.7. The ratio of stearic acid to sorbitol is chosen to produce either the mono- or the tristearate. Water is continuously removed by distillation. Sodium hydroxide (Griffin, 1945) and zinc stearate (Szabo et al., 1977) have been used as catalysts.

Because of the high temperatures required to achieve homogeneity of the reaction mixture, caramelization side reactions occur which produce dark colored compounds. These side reactions may be reduced by inclusion of a reducing agent, such as sodium hypophosphite (Furuya et al., 1992). An alternative process has been described in which sorbitol is reacted with an acidic catalyst at lower temperatures to form Sorbitan and isosorbide (Stockburger, 1981). The mixture is purified and reacted with stearic acid to produce the emulsifier.

As with preparation of the monoacylglycerols, following the decrease in acid value may be used to monitor the progress of the reaction. Infrared or near infrared spectroscopy may be used to determine disappearance of the hydroxyl group. Although these tests are fairly rapid, they do not provide any information about the molecular distribution. Gas chromatography has been used to obtain such information (Sahasrabudde and Chadha, 1969) (Giacometi et al., 1995). The reaction mixture may also be analyzed by HPLC (Garti and Asarin, 1983) Unfortunately; these methods are more complex and time-consuming. The final product must meet tight values for hydroxyl value and saponification number (see Chap. 3). Sorbitan monostearate and monooleate are used as intermediates in the production of polysorbates, discussed in a later section.

2.6 Sucrose Esters

Fully esterified sucrose fatty acid esters have been widely investigated as synthetic fat replacements (Akoh and Swanson, 1994) and their synthesis has been reviewed (Swanson and Swanson, 1999). Partially esterified sucrose esters are versatile emulsifiers for food products. A typical reaction is displayed in Fig. 2.8. The distribution of mono- di- and triesters, and therefore the HLB, may be controlled by the ratio of fatty acid and sucrose in the reaction mixture. The degree of saturation and chain length of the fatty acid also influence the functional properties of the product.

As with other polyol starting materials, sucrose fatty acid esters are prepared by interesterification. However, sucrose undergoes caramelization reactions above 140 °C. High temperatures cannot be used to force homogeneity of the two-phase reaction

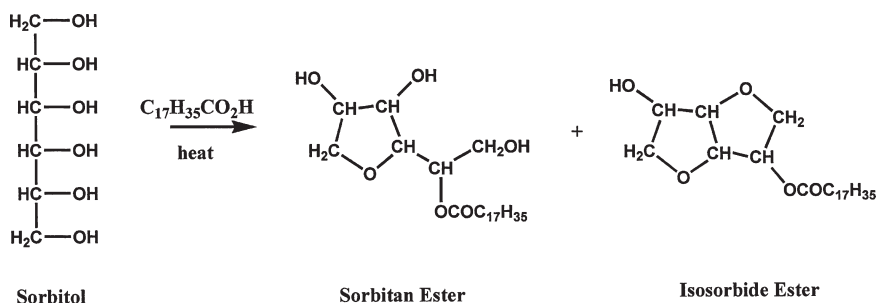

Fig. 2.7 Cyclization and esterification of sorbitol

mixture. One approach is to carry out a base-catalyzed interesterification with fatty acid methyl esters in a solvent, such as Dimethylformamide (DMF) (Wagner et al., 1990) or dimethyl sulfoxide (DMSO) (Kasori and Taktabagai, 1997). The major disadvantage of this method is the difficulty of completely removing the high-boiling, toxic solvent. A reaction has been reported in which hydrofluoric acid was used both as catalyst and solvent (Deger et al., 1988). In this case, hydrofluoric acid is extremely corrosive and hazardous to handle. Kinetics of the interesterification reaction have been described (Huang et al., 2000).

Another synthetic approach is the use of high levels of soap or other surfactants to promote miscibility of the phases (Meszaros et al., 1989). Excess soap may be removed by neutralization to the fatty acid, followed by short path distillation. Alternatively, solvent extraction, such as in an ethyl acetate/water mixture may be employed. Sucrose octaacetate, an oil soluble derivative of sucrose may be used as a starting material to promote a homogeneous reaction (Elsner et al., 1989). Reaction of sucrose with methyl esters can be performed with a high-shear, mixer to improve contact between the insoluble phases (Van Nispen and Olivier, 1989). A continuous process, where the reaction mixture is passed through an immobilized solid catalyst, has been described (Wilson, 1999). A two-component emulsifier system of sucrose esters and monoacylglycerols may be obtained by interesterification of sucrose and triacylglycerols (Nakamura et al., 1986). Enzyme catalyzed interesterification may be used to produce regioselective isomers of sucrose esters (Li et al., 2003).

Reaction of 2 moles of acetic acid and 6 moles of isobutyric acid with one mole of sucrose produces an oil analog with short alkyl chains and consequently higher specific gravity. The resulting food additive, sucrose acetate isobutyrate (SAIB) is used as a weighting agent in beverages (Reynolds and Chappel, 1998). Emulsions are stabilized by reduction of the water/oil density differential.

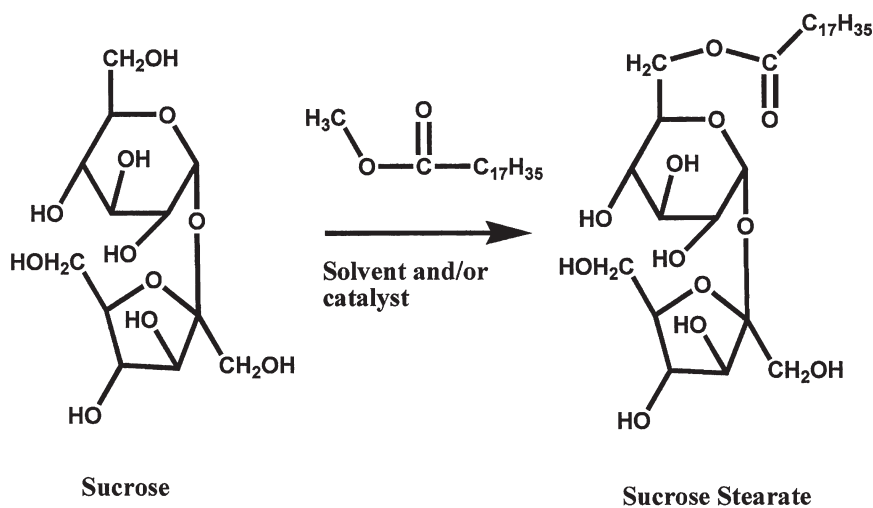

Fig. 2.8 Preparation of sucrose esters

Composition of the reaction product may be determined by thin layer chromatography (TLC) (Li, 2003) or reverse-Phase high performance liquid chromatography (RPHPLC) (Murakama et al., 1989) (Okumura et al., 2001). Esterification homologs can also be determined by electrospray mass spectrometry (Schuyt and Platerink, 1994).

2.7 Sodium and Calcium Stearoyl Lactylate

A surfactant with a carboxylic acid functional group may be nonionic, or if reacted with sodium or calcium hydroxide, converted into an anionic molecule. Lactic acid is a bifunctional molecule, which can self-condense to form an oligomer or react with a fatty acid to form stearoyl lactic acid (Eng, 1972). Reaction with sodium or calcium hydroxide forms sodium or calcium stearoyl lactylate. Figure 2.9 shows the dimeric homolog, known as sodium stearoyl 2-lactylate.

In a typical preparation, lactic acid is neutralized with sodium or calcium hydroxide and excess water is removed by distillation. Iron is highly detrimental to the quality of the product. Consequently, raw materials should have minimum iron content and the reactor should contribute no leachable iron. Stearic acid is added and esterification is carried out at 160–180 °C. Higher temperatures lead to side reactions, which produce dark colors and disagreeable odors and flavors. Water of reaction is removed by distillation and acid value is monitored until a minimum value is obtained.

Color of the final product may be improved by bleaching with 30% hydrogen peroxide (Anon, 1981) followed by heating to destroy excess peroxide. The final product is characterized by acid value, saponification number and total lactic acid (Franzke and Kroll, 1980).

2.8 Derivatives of Monoacylglycerols

Mono- and diacylglycerols have a significant mass of lipophilic functionality. The hydroxyl head group is small and nonionic. The size and charge of the head group may be varied by reacting monoacylglycerols with polar functional groups. The result is an increase in hydrophilicity for the emulsifier. Table 2.1 shows several derivatives of monoacylglycerols.

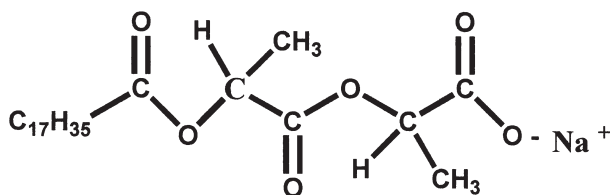

Fig. 2.9 Structure of sodium stearoyl lactylate

Table 2.1 Some monoacylglycerol derivatives

Acetate	$\begin{array}{c} \text{~O}-\text{C}-\text{CH}_3 \\ \parallel \\ \text{O} \end{array}$
Lactate	$\begin{array}{c} \text{~O}-\text{C}-\text{C}-\text{CH}_3 \\ \parallel \quad \\ \text{O} \quad \text{OH} \\ \quad \quad \\ \quad \quad \text{H} \end{array}$
Phosphate	$\begin{array}{c} \text{~O}-\text{P}-\text{O}^- \\ \parallel \\ \text{O} \\ \\ \text{OH} \end{array}$
Succinate	$\begin{array}{c} \text{~O}-\text{C}-\text{C}-\text{C}-\text{O}^- \\ \parallel \quad \quad \parallel \\ \text{O} \quad \text{H}_2\text{C} \quad \text{H}_2 \quad \text{O} \end{array}$
Citrate	$\begin{array}{c} \text{~O}-\text{C}-\text{C}-\text{C}-\text{CO}_2\text{H} \\ \parallel \quad \quad \\ \text{O} \quad \text{H}_2 \quad \text{OH} \\ \quad \quad \quad \\ \quad \quad \quad \text{COO}^- \end{array}$
Diacetyltartarate	$\begin{array}{c} \text{~O}-\text{C}-\text{C}-\text{C}-\text{C}-\text{O}^- \\ \parallel \quad \quad \quad \parallel \\ \text{O} \quad \text{H} \quad \text{H} \quad \text{O} \\ \quad \quad \quad \quad \quad \quad \\ \quad \quad \quad \text{O}-\text{C}-\text{CH}_3 \quad \text{O} \\ \quad \quad \quad \parallel \quad \quad \quad \parallel \\ \quad \quad \quad \text{O} \quad \quad \quad \text{O} \\ \quad \quad \quad \quad \quad \quad \\ \quad \quad \quad \text{H}_3\text{C}-\text{C} \quad \text{H}_3\text{C}-\text{C} \\ \quad \quad \quad \parallel \quad \quad \quad \parallel \\ \quad \quad \quad \text{O} \quad \quad \quad \text{O} \end{array}$

2.8.1 Acetylated Monoacylglycerols

Addition of an acetyl group replaces a free hydroxyl group and, as a result, a less hydrophilic molecule is produced. Because of their alkyl chain diversity, acetylated monoacylglycerols are excellent film-formers (Guillard et al., 2004).

Two methods for preparation of these surfactants are commonly used. (1) Monoacylglycerols are reacted with acetic anhydride to produce the acetate ester and one equivalent of acetic acid. The reaction is catalyzed by strong mineral or organic acids. If the reaction vessel is suitably equipped, acetic acid may be removed by distillation and recycled to regenerate acetic anhydride. (2) Monoacylglycerols may also be reacted with glyceryl triacetate (triacetin) using an alkaline catalyst. Although acetic acid is not formed as a by-product, glyceryl di- and triacetate is produced and must be removed by distillation at reduced pressures. The advantage of the latter process is that the reaction mixture is less corrosive and less flammable.

2.8.2 *Lactylated Monoacylglycerols*

As mentioned previously, lactic acid is a bifunctional molecule with both a free hydroxyl and free carboxyl group. When the carboxyl group is condensed with a hydroxyl group of a monoacylglycerol, a lactylated monoacylglycerol is formed. This has the effect of enlarging the hydrophilic group, while maintaining its nonionic character.

Synthesis of the surfactant is accomplished in two stages: (1) Preparation of the mono/diacylglycerol or distilled (90 +%) monoacylglycerol. (2) Reaction of this intermediate with lactic acid (Woods, 1961). Kinetics of the reaction are similar to direct esterification of glycerol with fatty acids. Water of reaction is generated and continuously removed and, the acid value decreases with time. Temperature of the reaction is limited to a maximum of 170–180 °C. Higher temperatures cause caramelization side-reactions of lactic acid. The degree of esterification (1–2) is controlled by the lactic acid/monoacylglycerol ratio in the reaction mixture (Shmidt et al., 1976b). After the reaction is complete, lactate esters of free glycerols must be removed because they contribute to strong off-flavors in finished food products. Steam distillation and aqueous extraction are commonly used for this purpose. The product may be characterized by acid value, saponification number, water-insoluble combined lactic acid (WICLA), and chromatography (Shmidt et al., 1976a).

2.8.3 *Succinylated Monoacylglycerols*

Succinic anhydride is similar to acetic anhydride in its reaction with monoacylglycerols. However, since a carbon chain tethers the two carboxyl groups, the second carboxyl group is retained in the surfactant molecule rather than expelled as an acid by-product. The hydrophilic group is enlarged and is anionic at the appropriate pH.

In a typical synthesis, a purified monoacylglycerol is reacted with succinic anhydride under an inert atmosphere (Freund, 1968; Hadeball et al., 1986). Precautions must be taken while handling succinic anhydride since it has been identified as a cancer suspect agent (Sax and Lewis, 1989). Although the reaction is exothermic, heat is added to raise the temperature to 150–165 °C in order to promote homogeneity of the reaction mixture. Since succinic acid is bifunctional, it may react with one or two monoacylglycerol molecules. The ratio of monoester/diester has been found to be ~6.5 (Hadeball et al., 1986). The product is characterized by acid value, melting temperature, free succinic acid, and chromatography (Shmidt et al., 1976).

2.8.4 *Citrate Esters of Monoacylglycerols (CITREM)*

Condensation of monoacylglycerol with citric acid or its anhydride produces a derivative with diverse functional groups. The hydrophilic head group is expanded in

size and polarity. In addition to their surface and interfacial activity, the citrate esters can chelate transition metals, which promote oxidation, such as iron and copper.

Preparation of the citrate esters is carried out by reacting acylglycerol with citric acid or its anhydride in the presence of an acid catalyst, e.g., acetic acid (Bade, 1978). The anhydride method can be carried out at lower temperatures. However, this process is more expensive because of the extra step necessary to synthesize of the anhydride. When citric acid is used, temperatures above 130 °C must be avoided to prevent decomposition of the acid.

2.8.5 Diacetyltartaric Acid Esters of Monoacylglycerols (DATEM)

Like succinylated and citrate derivatives, DATEM results from the condensation of a monoacylglycerol with a polycarboxylic acid. In this case, the acetate esters serve as protecting groups to prevent the self-condensation of tartaric acid. The resulting surfactant has an enlarged hydrophilic head group, which may exhibit anionic character at pH values above the pK_a .

Synthesis of this surfactant is accomplished in two or three stages: (1) Diacetyltartaric acid is produced by reacting tartaric acid with acetic anhydride, using sulfuric acid as a catalyst (Gladstone, 1960). (2) Optionally, the diacetyltartaric acid may be converted to its anhydride. (3) Diacetyltartaric acid or its anhydride is reacted with a monoacylglycerol. As with CITREM, the anhydride reaction proceeds under less stringent conditions but is more costly. Bound and free tartaric acid may be determined by extraction/saponification and UV spectrometry (Shmidt et al., 1979).

An interesting class of compounds has been produced by reaction of diacetyltartaric acid with fatty acids using a transacylase or lipase enzyme (Aracil Mira, 2000). In this reaction, fatty acids are esterified to the hydroxyl groups on tartaric acid. Surface properties and food applications of these compounds have not been extensively investigated.

2.8.6 Monoacylglycerol Phosphate

Conversion of a free hydroxyl group on monoacylglycerols with a phosphate ester introduces four (1P + 3O) additional electronegative heteroatoms into the molecule. The surfactant can become anionic at $pH > pK_a$.

Synthesis comprises reaction of a monoacylglycerol with phosphoric acid (Cawley and O'Grady, 1969), polyphosphoric acid (Kazyulima et al., 1986), or phosphorous pentoxide. As with other reactions described in this chapter, the mixtures are initially heterogeneous, but as the reactions proceed, the surfactant product coalesces into a single phase. Alternatively, a solvent may be used to obtain homogeneity under less stringent conditions. A synthesis directly from triacylglycerols has been reported (Ranny et al., 1989); in this process, the reactants are heated at

120 °C in the presence of P₂O₁₀ as a catalyst. The reaction is continued until triacylglycerols concentration reaches a minimum. Mono- and diacylglycerol phosphates may also be obtained by phospholipase modification of lecithin (see Sect. 2.10.1). The phosphoric acid esters from these reactions are neutralized with an alkaline sodium salt to yield an anionic surfactant.

2.9 Polyoxyethylene Derivatives

Ethylene oxide (oxirane) is a molecule with a three-membered, oxygen-containing ring. Since ring-strain is high, the molecule can readily undergo an exothermic SN-2 ring-opening reaction. The open ring nucleophile can then condense with a second molecule of ethylene oxide to initiate a polymerization chain reaction. Surfactants have been synthesized by using fatty acids or fatty alcohols as the initiating nucleophiles. The resulting polyoxyethylene chain is a large polar head group, which may also chelate cations to a small extent. In the food industry, sorbitan esters and monoacylglycerols have been ethoxylated to form higher HLB surfactants.

2.9.1 Polyoxyethylene Sorbitan Esters (Polysorbates)

The synthesis of sorbitan esters was previously discussed in Sect. 2.5. Although sorbitan monooleate is not approved for use in foods, its ethoxylated derivative is permitted. The nomenclature of sorbitan esters and polysorbates has evolved from the trade names of surfactants marketed by ICI Inc. The system is shown in Table 2.2

A number of challenges arise in the synthesis of ethoxylates. Ethylene oxide has a boiling point of 10.4 °C (Udajari, 1996a). Therefore ethylene oxide is a gas at ambient temperature. It is also a suspected carcinogen so reaction mixtures must be tightly contained to avoid exposures. Ethylene oxide may also dimerize to form dioxane, another carcinogen suspect. Great care must be taken to completely remove dioxane from the final product. Unlike other reactions in this chapter, ethoxylation is exothermic. Slow addition rate, efficient mixing and heat exchange are necessary to avoid explosions.

In a typical preparation (Fig. 2.10), a sorbitan ester is introduced into a pressure reactor, similar to that used for hydrogenation. Ethylene oxide is added while the reactor is cooled to remove the heat of reaction. Slow addition serves to moderate

Table 2.2 Nomenclature of sorbitans and polysorbates

Fatty acid (abbreviated)	Sorbitan ester	Ethoxylated derivative
Lauric (12:0)	Sorbitan monolaurate	Polysorbate 20
Palmitic (14:0)	Sorbitan monopalmitate	Polysorbate 40
Stearic (16:0)	Sorbitan monostearate	Polysorbate 60
Stearic (16:0)	Sorbitan tristearate	Polysorbate 65
Oleic (18:1)	Sorbitan monooleate	Polysorbate 80

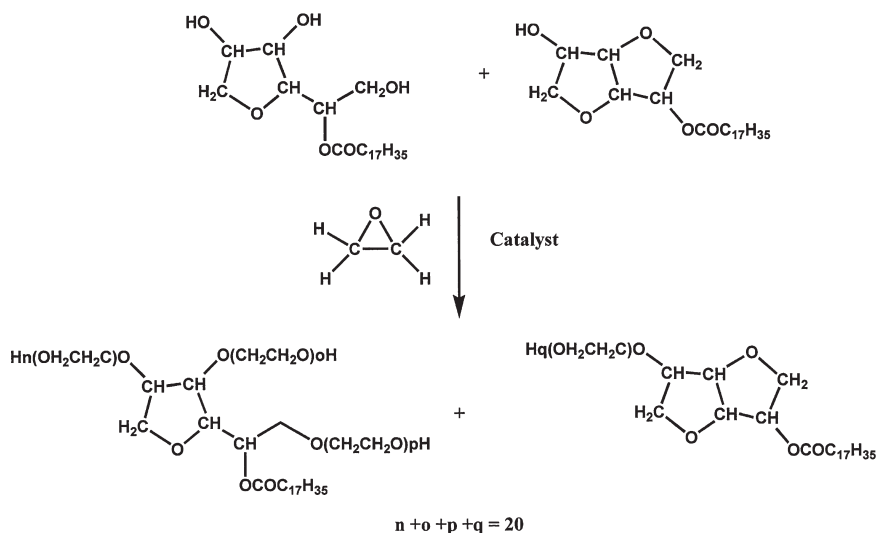

Fig. 2.10 Ethoxylation to convert sorbitan esters to polysorbates

the exotherm and to minimize the extent of dimerization. After the reaction has been completed, the product is steam distilled to remove any traces of dioxane. Saponification number, hydroxyl value and polyoxyethylene content characterize the product. Negative ion ionization mass spectrometry has also been used to determine the distribution in polymeric chains (Brumley et al., 1985). This technique may be valuable to sort out subtle differences in product functionality in foods.

2.9.2 Ethoxylated Mono- and Diacylglycerols

Preparation of this surfactant is carried out in two stages: (1) Mono- and diacylglycerols are prepared from saturated fats or fatty acids. However, in this case, the alkaline catalyst is not neutralized but carried over to the second reaction. (2) Ethoxylation is carried out in a fashion similar to sorbitan esters, but the temperature is raised to 170–180 °C. The product is steam or nitrogen deodorized to remove dioxane. Excess catalyst is removed by filtration.

2.10 Modification of Naturally Occurring Species

Many naturally occurring compounds have been used to impart functional properties to food products. For example, gums such as sodium alginate have been used to stabilize emulsions by thickening the aqueous phase. Lecithin has been used as

an emulsifier in margarine and for viscosity control in chocolate. These compounds may be physically, enzymatically, or chemically modified to improve their amphiphilic characteristics.

2.10.1 Modified Lecithins

Lecithins are found in animals and vegetables as essential components of membranes. Two major differences may be observed: (1) Animal sources have higher saturated fatty acids esterified at the sn-1 and sn-2 positions, while those from vegetables are unsaturated. (2) Animal and vegetable lecithins vary in the distribution of groups esterified to the terminus of the phosphate (mainly choline, ethanolamine and inositol). Egg yolk and soy lecithins are the most widely used in the food industry (Szuhaj, 2005).

Egg yolk is generally separated from whole egg and may be dried or frozen, if not used immediately. Egg lecithin may be further purified by extraction with ethanol (Sim, 1994). Soy lecithin is obtained by degumming crude soybean oil. Both these “raw” lecithins are complex mixtures, which contain significant quantities of triacylglycerols. Solvents may be used to separate lecithin from these triacylglycerols. For example soy lecithin may be precipitated (de-oiled) by acetone. Lecithin may also be fractionated into its constituents. For example, egg yolk lecithin can be purified and fractionated by sequential extraction with ethanol, hexane and acetone (Palacios and Wang, 2005). Soy lecithin may be enriched in phosphatidylcholine by extraction with ethanol (Gu, 2002; Belitz et al., 2004a).

Lecithin may also be chemically or enzymatically modified to obtain a wider variety of HLB values or surface properties. As shown in Fig. 2.11, phospholipase enzymes may be used to cleave selected ester bonds. In egg yolk or soy, phospholipase A2 cleaves the ester bond at sn-2 to produce lysolecithin, a single tailed surfactant (Hibino et al., 1991; Morgado et al., 1995). The reaction may be carried out in reverse to produce lysolecithin from glycerolphosphatidylcholine and a fatty acid (Hibino et al., 1989). These reactions are carried out in emulsions or organic solvents in the presence of calcium ions. Phospholipase A2 may be added to crude soybean oil to make lecithin more hydratable and therefore easier to separate. Phospholipase D cleaves the ester bond between the phosphate and the head group. Diacylglycerol [phosphate may be produced from lecithin using this enzymatic hydrolysis reaction (Wang et al., 1997). Head groups on lecithins may be interchanged (transphosphatidylation) by reaction with phospholipase D and a hydroxyl-containing molecule (Masashi et al., 2005). The method does not appear to require organic solvents or calcium.

A second polar head group may be introduced into the soy lecithin molecule by reaction with hydrogen peroxide (Sietze, 1982). A four-centered reaction adds two hydroxyl groups across a double bond in a fatty acid chain. Surface activity is increased and the molecule can adopt a looped “inchworm” structure at the interface.

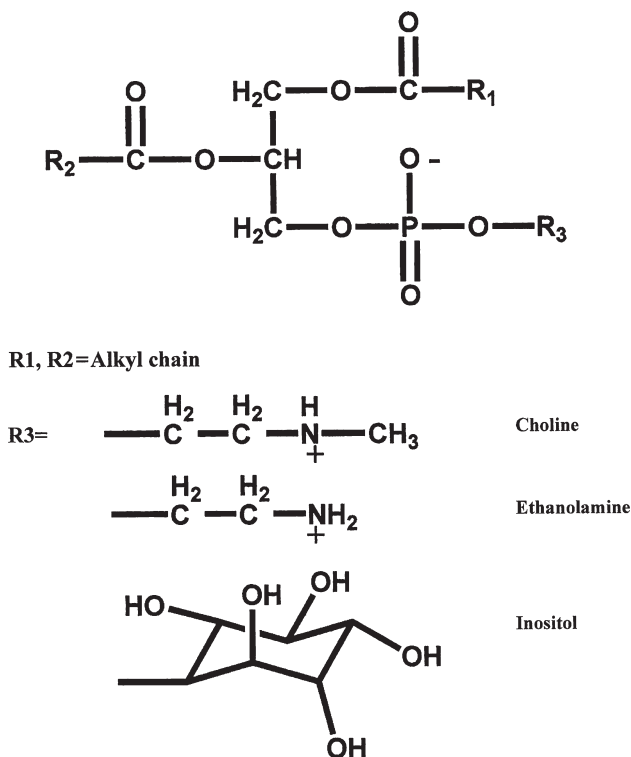

Fig. 2.11 Major phospholipids of lecithin

2.10.2 Propylene Glycol Alginate

Alginic acid is a polar hydrocolloid containing hydroxyl groups, derived from seaweed. It is a copolymer of mannuronic and guluronic acids. Sodium and calcium salts of this ingredient form gels and are used as thickeners in a number of food products. These ingredients do not display appreciable surface activity. Esterification of the free carboxyl groups with propylene glycol or propylene oxide reduces the hydrophilicity of the ingredient. Approximately 80% of the carboxyl groups can be esterified (McDowell, 1970; McDowell, 1975). Figure 2.12 shows a unit of the esterified alginate containing mannuronic and guluronic acids.

Propylene oxide is a volatile liquid with a boiling point of 34 °C (Udajari, 1996b). Like ethylene oxide, propylene oxide is extremely flammable and exposure can cause burns and blistering. In a typical procedure, a concentrated alginic acid is reacted with propylene oxide in a pressure reactor at 65–80 °C for 30–60 min (Nielsen et al., 1971). The degree of esterification can be improved by neutralization of the acid with sodium hydroxide (Noto and Pettitt, 1972; Strong, 1976; Ha et al., 1987).

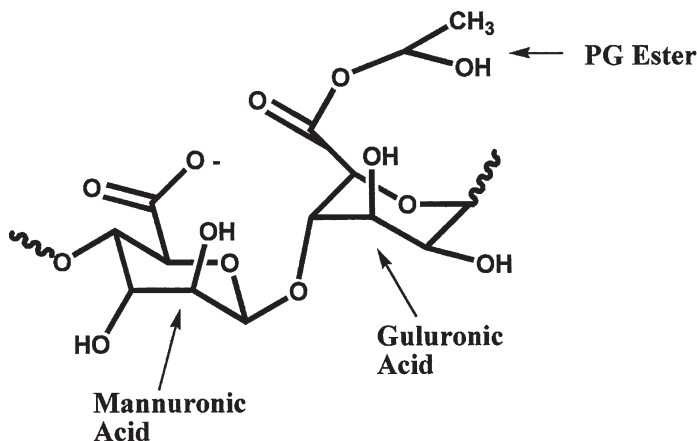

Fig. 2.12 Structure of propylene glycol alginate

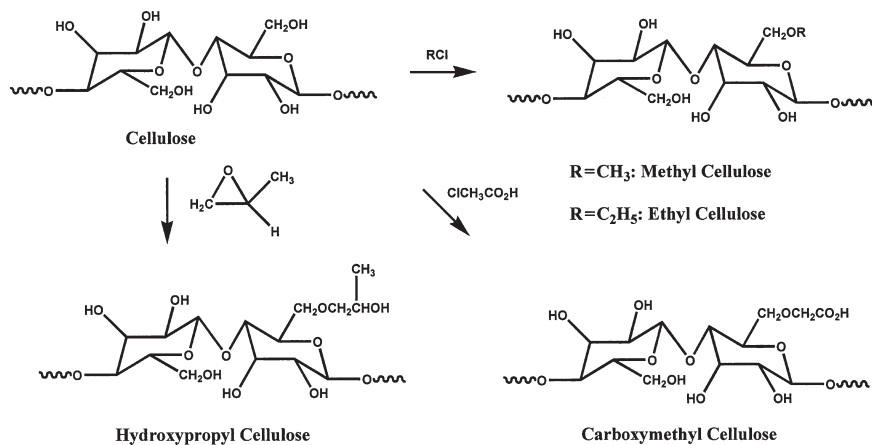

Fig. 2.13 Cellulose derivatives

2.10.3 Alkyl Esters of Cellulose

Cellulose is polymeric carbohydrate of glucose, which differs from starch in stereochemistry of the bond between monomers. It is a very tight structure and is used as a source of fiber in food products. Hydroxyl groups in the cellulose may react to form an interrupted structure, which results in greater water absorption and swelling. Lipophilic groups are also introduced to provide some surface activity. Methyl and ethyl chlorides are reacted to give methyl and ethyl ethers. Chloroacetic acid yields carboxymethyl cellulose. Analogous to the synthesis of propylene glycol alginate, propylene oxide reacts to form hydroxypropylcellulose, an ether-alcohol. Structures of these cellulose derivatives are shown in Fig. 2.13. The degree of substitution is determined by the ratio of reactants and the reaction conditions (Belitz et al., 2004b).

2.11 Commercial Preparation of Food Surfactants

Syntheses of surfactants in the laboratory and in commercial reactors are often different. On a small scale in glass equipment, corrosive and toxic materials can be handled and reaction products can be purified using chromatographic methods. Although glass lined reactors are available commercially, they are vulnerable to breakage and pinhole leaks. Chromatographic purification on a large scale is frequently uneconomical. The choice between batch or continuous process depends on product volumes and product mix. A continuous process is well suited to a few products produced in large volume. A large number of products, produced in smaller quantities are best prepared by a batch process. Direct esterifications with fatty acids need to be performed in a batch process because of their slower reaction rates.

2.11.1 Batch Esterification/Interesterification

Commercial batch reactors are generally constructed of carbon or stainless steel. High molybdenum stainless steel is required if strong acids are involved in the reaction, for example, in direct esterification with fatty acids at high temperatures. In a typical process, a polyol, fat or fatty acid and a catalyst are weighed or metered from storage tanks into the reactor. A nitrogen atmosphere is maintained and heat is applied through a jacket or heating coils. When the reaction is completed, a neutralizing agent is introduced and cooling is applied through the coils or jacket. Most often, heating and cooling coils are separate systems. A high boiling heat exchange fluid is used for heating and water is used for cooling. Excess polyol is removed by distillation, gravitational separation, or extraction. The product is filtered and pumped to storage.

Figure 2.14 shows a schematic of a typical batch reactor. Some critical design criteria for batch reactors are (1) The reactor, piping, and storage tanks must be constructed of corrosion-resistant materials. In addition to damage to equipment, iron or copper leached into products may act as pro-oxidants, which lead to quality problems. (2) Meters and/or scales used to measure reactants must be accurate and precise in order to maintain consistent product quality. (3) If excess polyols are to be recycled, fractionation efficiency must be sufficient to prevent cross-contamination of subsequent batches. (4) Sufficient heat capacity is essential to allow rapid heating and cooling of reaction mixtures. (5) Starting oil storage, the reactor, filtration apparatus, and product storage should be protected with an inert atmosphere to minimize degradation reactions caused by oxygen. (6) An adequate cleaning system is necessary to prevent cross-contamination between products. A waste treatment system is needed to avoid environmental contamination.

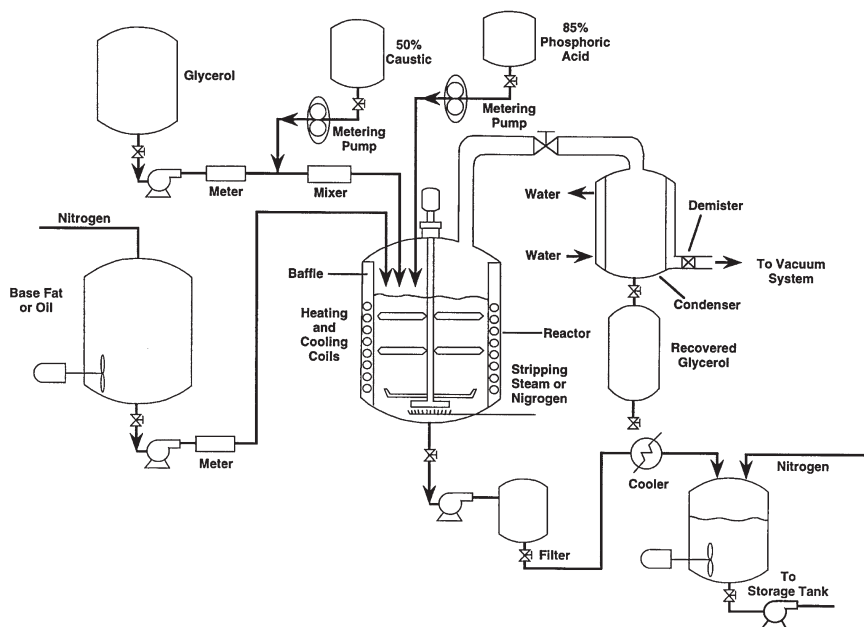

Fig. 2.14 Typical batch esterification reactor (Hasenhuettl, 1999a). Reproduced with permission of Elsevier Ltd

2.11.2 Continuous Interesterification Reactors

Continuous processes are generally economical, because once conditions are established; large volumes of product may be produced as long as the process is maintained under control. In a typical commercial reactor, as shown in Fig. 2.15 (Allen and Campbell, 1967), oil, polyol and catalyst are metered through a multiplex pump into a heated flow-through reactor. At high temperature, homogeneity is rapidly achieved. The product stream then exits to a falling-film evaporator, where excess polyol is removed at reduced pressure. Since the residence time in the evaporator is short, pre-neutralization is not necessary to prevent disproportionation. The product is neutralized, filtered, and sent to storage or packaging.

Some critical design factors for continuous reactors are (1) An inert atmosphere should be provided for reactants and products to prevent oxidative degradation. Since there is little or no headspace in the reactor, only dissolved gases can produce side reactions. (2) The metering pump must be accurate and stable in order to produce consistent product with minimal off-grade product. (3) Heat exchange capacity in the reactor must be sufficient to raise the temperature as high as 260° C while maintaining adequate product flow. (4) The falling film evaporator must be sufficient to consistently remove excess polyol. For two polyols, such as propylene glycol and glycerol, either two evaporators in series must be used or the polyol mixture must

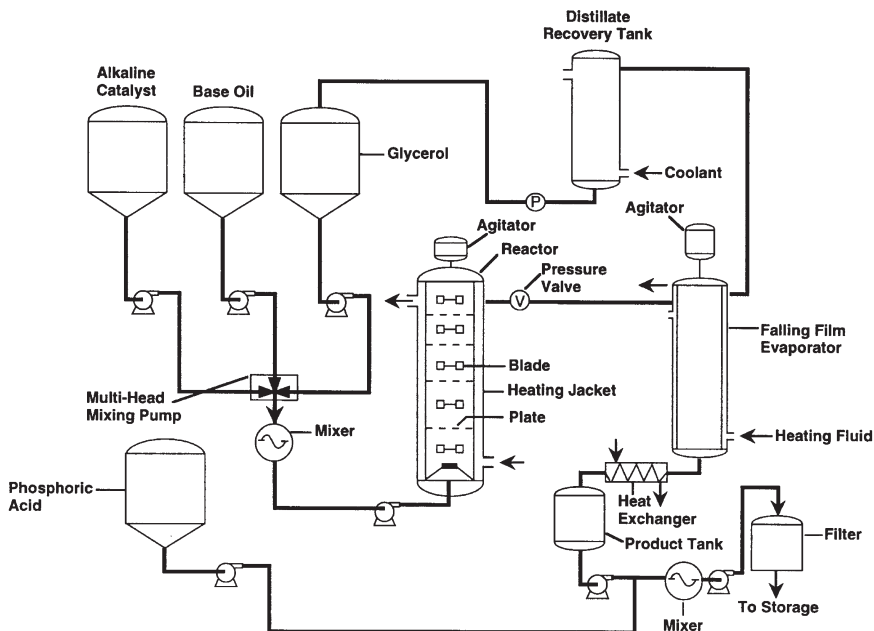

Fig. 2.15 Continuous esterification reactor (Allen and Campbell, 1967; Hasenhuettl, 1999b). Reproduced with permission of Elsevier Ltd

be separated in a subsequent process. (5) Neutralization and filtration should be sufficiently robust to produce a clear molten product.

2.11.3 Bioreactors for Esterification/Interesterification

Esterification and interesterification syntheses can be accomplished with intact microorganisms or purified lipase or esterase enzymes. The bioreactors may be either batch or continuous. Some advantages of bioreactors are (1) Operation at lower temperatures, lower energy costs and reduced undesirable side reactions. (2) Stereoselective reactions, where fatty acids combine with primary alcohols, can yield products with higher concentrations of hydrophilic surfactant molecules. For example, sucrose may be selectively esterified to yield mono and diesters (Li et al., 2003). (3) Materials of construction do not have to be as corrosion-resistant as vessels operating at higher temperatures. Because temperatures are low and less corrosive materials are used, the safety of operating personnel is improved.

Some disadvantages of bioreactors are (1) High cost and denaturation of the enzyme make the process expensive. (2) Heterogeneity must be overcome at relatively low temperature by using solvent or carrying out the reaction on large interfacial areas. (3) Reaction rates are slow. For direct esterifications, water must be

removed to shift the equilibrium. However, a small amount of water is necessary to maintain the activity of the enzyme

Stirred tank and fixed bed reactors were initially used to carry out reactions with enzymes and microorganisms (Patterson et al., 1984),(Arcos et al., 2000). Residence time, exposure to enzyme, and polyol/fatty acid ratio were the critical factors controlling the rate and selectivity of the reaction. A flow-through microporous membrane reactor, as shown in Fig. 2.16, has been used to produce surfactants (Yamane et al., 1984; Hoq et al., 1985). A fatty acid stream is passed along one side of the membrane

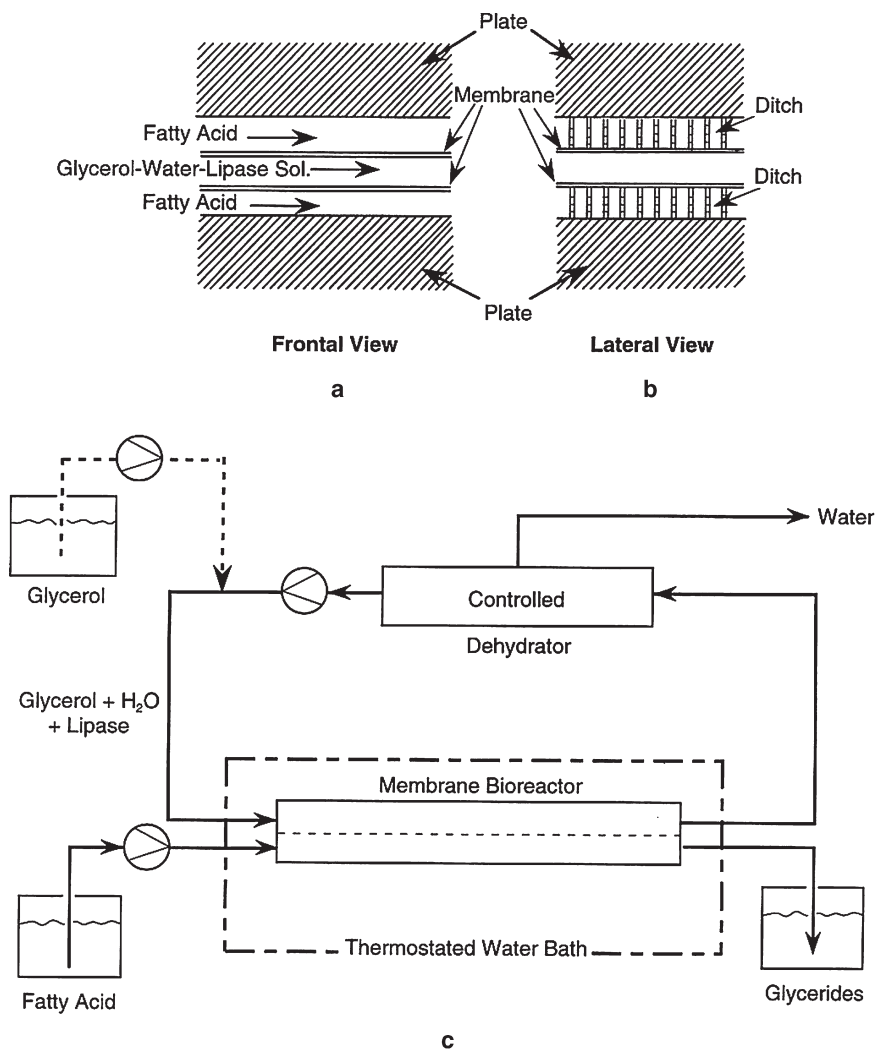

Fig. 2.16 An enzymatic esterification reactor (Hasenhuettl, 1999c). Reproduced with permission of Elsevier Ltd

while glycerol, an activating concentration of water, and lipase enzyme are passed along the other side. An improvement using a pervaporative membrane has been developed and design factors reviewed (Lim et al., 2002). This reactor system enables the evaporative separation of water, thus shifting the reaction equilibrium. In another recent improvement, protein, lipid, or chitosan may be deposited on the surface of a macroporous membrane. The film improves phase contact in the reactor. Design factors have been reviewed for this reactor type (Paolucci-Jeaniean, 2005).

2.11.4 Ethoxylation/Propoxylation Reactors

Reactions of ethylene or propylene oxide may be carried out in batch, continuous, or semi-continuous systems. Since the epoxides are generally in the gaseous state at reaction temperatures, liquid polyols may be sprayed through a tower containing these reactive compounds (Santacesaria, 1999). In designing ethoxylation reactors, careful consideration must be given to safety factors. Since the epoxides are cancer suspect agents, leakage must be prevented and exposure of workers strictly monitored. Ethoxylation reactions are exothermic and heat must be efficiently removed in order to avoid explosion or fire. Solubility of the epoxide in the reaction mixture is the most critical factor controlling the reaction rate (Santacesaria et al., 1995).

Acknowledgments This chapter is dedicated to Dr. Richard J. Zielinski, whose contributions to the field are embodied in many commercial food emulsifiers. The author is grateful to Julia Hasenhuettl for her valuable assistance with literature searches and manuscript preparation.

References

- Akoh, C. and Swanson, B. G. (1994). *Carbohydrate Polyesters as Fat Substitutes*. New York: Marcel Dekker.
- Allen, R. R. and Campbell, R. L. (1967). Process for the Manufacture of Fatty Acid Esters. U. S. 3,313,834, Anderson Clayton & Co.
- Anon (1981). Sodium Stearoyl 2-Lactylate. India 148301, Council for Scientific and Industrial Research India: 13.
- Aoi, N. (1995). Preparation of Fatty Acid Esters of Fractionated Polyglycerin Esters as Emulsifiers. HCAPLUS 124:185549. Japan 07218560A, Toiyo Kogaku KK.
- Aracil Mira, J. A. E. (2000). Producing Fatty Acid Esters of Diacetyltartaric Acid Using Biocatalysis. Spain ES2146162, Universidad Complutense.
- Arcos, J. A. et al. (2000). Continuous Enzymatic Esterification of Glycerol With (Poly)Unsaturated Fatty Acids in a Packed Bed Reactor. *Biotechnol. Bioeng.* **68**(5): 563–70.
- Bade, V. (1978). Process for the Manufacture of Citric Acid Esters of Partial Fatty Acid Glycerides. U.S. 4, 071, 544.
- Belitz, H. D., Grosch, W., and Schienberle, P. (2004a). *Food Chemistry*. Berlin: Springer. 178–179.
- Belitz, H. D., Grosch, W., and Schienberle, P. (2004b). *Food Chemistry*. Berlin: Springer. 331–2.
- Brumley, W. C. et al. (1985). Characterization of Polysorbates by OH-Negative Ion Chemical Ionization Mass Spectrometry. *J. Agric. Food Chem.* **33**(3): 368, 72.

- Cawley, C. and O'Grady, M. (1969). Preparation of Monoglyceride Phosphoric Acid and Salts Thereof. U.S. 3, 423, 440.
- Charlemange, D. and Legoy, M. D. (1995). Enzymic Synthesis of Polyglycerol Fatty Acid Esters in a Solvent-free System. *J. Am. Oil Chem. Soc.* **72**(1): 61–5.
- Charles, G. et al. (2003). Preparation of Diglycerol and Triglycerol via Direct Polymerization of Glycerol with Basic Mesoporous Catalysts. *Oleagineux Corps Gras Lipides* **19**(1): 74–82.
- Deger, H. M. et al. (1988). Carbohydrate Fatty Acid Esters, a Method for Their Preparation. HCAPLUS 111:134679. German DE 639878 A1, Hoechst, A. G.
- Dong, Q. Q. et al. (1982). *Lipids* **17**(11): 798–802.
- Elsner, A. et al. (1989). Synthesis and Characterization of Sucrose Fatty Acid Polyesters. *Nahrung* **33**(9): 845–51.
- Eng, S. (1972). Producing Lactic Acid Esters of Fatty Acids. U.S. 3, 636, 017, Glyco, Inc.
- Esbuis, C. R. V. et al. (1994). Polymerization of Glycerol Using Zeolite Catalysts. *PCT Int. Appl.* WO 9418256, Unichema Chemie B. V. Neth.
- Fränke, C. and Kroll, J. (1980). *Nahrung* **24**(1): 89–90.
- Freund, E. H. (1968). Composition Comprising Succinyl Half Esters. U. S. 3,370,958, National Dairy Products Co.
- Furuya, N. et al. (1992). Stabilization of Polyoxyethylene Sorbitan Esters. HCAPLUS 117:152184. Japan JP 04108781 A2, Nippon Yushi, K. K.
- Garti, N. and Asarin, A. (1983). *J. Am. Oil Chemists Soc.* **60**(6): 1151–4.
- Giacometti, J. et al. (1995). Monitoring the Esterification of Sorbitol and Fatty Acids by Gas Chromatography. *J. Chromatogr. A* **704**(2): 535–9.
- Gladstone, C. (1960). Process of Preparing Esters of Acetyl Tartaric and Citric Acids. U. S. 2,938,027, Witco Chemical Co.
- Griffin, W. C. (1945). U.S. 2, 380, 166.
- Gu, K. (2002). Study on Solvent Fractionation of Soybean Lecithin. *Zhongguo Youzhi* **27**(1): 31–3.
- Guillard, V. et al. (2004). Edible Acetylated Monoglycerid E Films: Effect of Film-forming Technique on Moisture Barrier Properties. *J. Am. Oil Chem. Soc.* **81**(11): 1053–8.
- Ha, J. H. et al. (1987). Optimum Conditions to Esterify Alginic Acid. *Hanlguk Susan Hakoehi* **20**(3): 202–7.
- Hadeball, K. et al. (1986). Synthesis and Properties of Succinylated Monoglycerides. *Nahrung* **30**(2): 209–11.
- Hari-Krishna, S. and Karanth, N. (2002). Lipase and Lipase-catalyzed Esterification Reactions in Nonaqueous Media. *Cat. Rev.* **44**(4): 499.
- Hasenhuettl, G. L. (1999a). Synthesis and Commercial Preparation of Surfactants for the Food Industry. In F. D. Gunstone (ed.), *Lipid Synthesis and Manufacture*. Sheffield: Academic Press. p. 391.
- Hasenhuettl, G. L. (1999b). Synthesis and commercial preparation of surfactants for the food industry. In F. D. Gunstone (ed.), *Lipid Synthesis and Manufacture*. p. 392. CRC Press.
- Hasenhuettl, G. L. (1999c). Synthesis and commercial preparation of surfactants for the food industry. In F. D. Gunstone (ed.), *Lipid Synthesis and Manufacture*. p. 394. CRC Press.
- Heidt, M. et al. (1996). Studies on the Enantioselectivity in Lipase Synthesis of Monoacylglycerols From the *i*Propylidene Glycerol. *Biotechnol. Tech.* **10**(1): 25–30.
- Hibino, H. et al. (1989). Preparation of Lysophosphatidylcholine by Acylation of Glycerophosphocholine. HCAPLUS 112:217462. Japan JP 01311088 A2, Nippon Oil & Fats Co.
- Hibino, H. et al. (1991). Hydrolysis of Synthetic Phosphatidylcholine with Phospholipase A2. HCAPLUS. Japan JP 03007589 A2, Mippon Oil & Fats Co.
- Hoq, M. M. et al. (1985). Some Characteristics of Continuous Glyceride Synthesis by Lipase in a Microporous Hydrophobic Biomembrane Reactor. *Agric. Biol. Chem.* **49**(2): 335–42.
- Huang, E.-C. et al. (2000). Kinetic Study on the Synthesis of Sucrose Esters. *Zhengzhou Gongye Daxue Xuebao* **21**(4): 4–6.
- Israelachvili, J. (1992). Thermodynamic Principles of Self-Assembly. in *Intermolecular and Surfaces Forces*. London: Academic Press, 341–94.
- Jakobson, G. et al. (1989). Preparation of Nonionic Surfactant Comprising Esters of Polyglycerol and Their Use in Emulsions. HCA PLUS 113:99881. German DE 3818293 A1, Deutsche-Solvay-Werke G.M.b.H.

- Kasori, Y. et al. (1995). Preparation of Polyglycerin Fatty Acid Esters at Controlled Temperatures. HCAPLUS 123:14329. Japan JP 071451, Mitsubishi Kagaku KK.
- Kasori, Y. and Taktabagai, T. (1997). Preparation of Fatty Acid Sucrose Esters for Foods. HCAPLUS 127:176658. Japan JP 09188690 A2, Mitsubishi Chemical Industries Ltd.
- Kazyulima, M. I. et al. (1986). Production of Phosphorous Containing Emulsifiers. *Maslo-Zhir. Prom-st.* **8**: 22–3.
- Li, Y.-K. et al. (2003). Enzyme-catalyzed Regioselective Synthesis of Sucrose Esters. *Yoppp Huaxue* **23**(8): 770–5.
- Lim, S. et al. (2002). Design Issues of Pervaporation Membrane Reactors for Esterification: Membrane Bioreactor Design and Kinetic Model for Reaction Engineering and Simulation: A Review. *Chem. Eng. Science* **57**(22–23): 4943–6.
- Marquez-Alvarez, C. et al. (2004). Solid Catalysis for the Synthesis of Esters of Glycerol, Polyglycerols and Sorbitol from Renewable Resources. *Top. Catal.* **27**: 105–17.
- Masashi, S. et al. (2005). Method for Producing Phospholipid. U. S.6,170,476A.
- McDowell, R. H. (1970). New Reactions of Propylene Glycol Alginate. *J. Soc. Cosmet. Chem.* **21**: 441–57.
- McDowell, R. H. (1975). New Developments in the Chemistry of Alginates and Their Use in Foods. *Chem. Ind.* **9**: 391–5.
- Meszáros, G. Y. et al. (1989). Synthesis of Esters of Polyols and Fatty Acids with Soap as Emulsifiers. HCA PLUS 111:216308. Europe EP 323670 A2, Unilever N.V, Unilever PLC.
- Montiero, J. B. et al. (2003). Lipase-catalyzed Synthesis of Monoacylglycerol in a Homogeneous System. *Biotechnol. Letters* **25**(8): 641–4.
- Morgado, M. A. et al. (1995). Hydrolysis of Lecithin by Phospholipase A2 in Mixed Reversed Micelles. *J. Chem. Technol. Biotechnol.* **63**(2): 181–9.
- Murakama, C. et al. (1989). *Shokuhin Eiseigaku Zasshi* **30**(4): 306–13.
- Nakamura, T. et al. (1986). Sucrose Fatty Acid Esters—Reaction at Atmospheric Pressure. *Inf. Int.* **18**(37): 8–13.
- Nielsen, V. et al. (1971). Propylene Glycol Alginate. German DE 204,6966.
- Noto, V. H. and Pettitt, D. J. (1972). Propylene Glycol Alginate. German DE 2641303, Merck & Company: DE 2641303.
- Okumura, H. et al. (2001). Determination of Sucrose Fatty Acid Esters by High Performance Liquid Chromatography. *J. Oleo Sci.* **50**(4), 249–54.
- Palacios, L. E. and Wang, T. (2005). Egg-yolk Lipid Fractionation and Lecithin Characterization. *J. Am. Oil Chem. Soc.* **82**(8): 571–8.
- Paolucci-Jeaniean, D. (2005). Biomolecule Applications for Membrane-based Phase Contacting Systems. *Chem. Eng. Res. Des.* **83**(A3): 302–8.
- Patterson, V. D. E. et al. (1984). Continuous Synthesis of Glycerides by Lipase in a Microporous Membrane Bioreactor. *Ann. N.Y. Acad. Sci.* **434**: 558–68.
- Polouze, J. and Gelis, A. (1844). *Ann. Chem. Phys.* **10**: 434.
- Ranny, M. et al. (1989). Manufacture of Phosphorylated Mono- and Diacylglycerols for Use as Food Emulsifiers. HCAPLUS: 111:193383. Czechoslovakia CS 256691 B1, Czechoslovakia.
- Reynolds, R. C. and Chappel, C. J. (1998). Sucrose Acetate Isobutyrate (SAIB): Historical Aspects of Its Use in Beverages and a Review of Toxicity Studies Prior to 1988. *Food Chem. Toxicol.* **36**(2): 81–93.
- Sahasrabudde, M. (1967). *J. Am. Oil Chem. Soc.* **44**(7): 376–8.
- Sahasrabudde, M. R. and Chadha, R. K. (1969). *J. Am. Oil Chem. Soc.* **46**(1): 8–12.
- Santacesaria, E. et al. (1995). Role of Ethylene Oxide Solubility in the Ethoxylation Process. Catalysis in Multiphase Systems: 549th Event of the EFCHE, Lyon, FR, Catal. Today.
- Santacesaria, E. (1999). Mass Transfer and Kinetics in Ethoxylation Spray Tower Loop Reactors. Proceedings of the 1999 1st International Symposium on Multifunctional Reactors, Amsterdam, NLD: Chemical Engineering Science.
- Sax, N. I. and Lewis, R. J. (1989). Succinic Anhydride. *Dangerous Properties of Industrial Materials*. New York: Van Nostrand Reinhold. III: 3131–2.
- Schuetze, T. (1977). *Nahrung* **21**(5): 405–15.

- Schuyl, P. J. W. and Platerink, V. (1994). Analysis of Sucrose Polyesters with Electrospray Mass Spectrometry. 42nd A.S.M.S. Conference on Mass Spectrometry, Chicago, IL.
- Shmidt, A. A. et al. (1976a). Chromatographic Analysis of Succinylated and Lactylated Monoglycerides as Food Surfactants. *Khimicheskaya Promyshlennost* **8**: 598–600.
- Shmidt, A. A. et al. (1976b). Synthesis of Lactylated Monoglycerides. *Masolzhironyaya Promyshlennost* **10**: 19–20.
- Shmidt, A. A. et al. (1979). Determination of the Tartaric Acid Content of Diacetyltartaric Acid Esters of Monoglycerides and Mono- and Diglycerides. *Lebensmittelindustrie* **26**(4): 172–3.
- Sietze, F. G. (1982). *Seifen Oele Fette Wachse* **108**(20): 637–9.
- Sigfried, P. and Eckhard, W. (2005). Process for the Transsterification of Fat and/or Oil by Means of Alcoholysis. U. S. 5,933,398 B2.
- Sim, J. S. (1994). New Extraction and Fractionation Method for Lecithin and Neutral Oil from Egg Yolk. *Egg Use and Processing Technology*, Wallingford, UK: CAB International.
- Stockburger, G. J. (1981). Process for Preparing Sorbitan Esters. U.S. 4,297,290, ICI Americas, Inc.
- Strong, C. H. (1976). Alkylene Glycol Alginates. German DE 2529086, Uniroyal, Ltd.
- Swanson, S. and Swanson, B. G. (1999). Alkyl and Acyl Sugars. In F. D. Gunstone (ed.), *Lipid Synthesis and Manufacture* pp. 347–70. Sheffield: Academic Press/CRC Press.
- Szabo, I. et al. (1977). Investigations on the New Preparation Possibilities of Span 80 and Tween 80. Conference on Applied Chemistry, Budapest, Magy. Kem. Egyesulete.
- Szuhaj, B. F. (2005). Lecithins. In F. Shahidi (ed.), *Bailey's Industrial Oil and Fat Products*. (vol 3, pp. 361–456). New York: John Wiley and Sons.
- Tamura, T. and Suginuma, T. (1991). Preparation of Higher Fatty Acid Monoglycerides as Emulsifiers and Moisturizers. HCA PLUS. Japan JP 03200744 A2, Daisan Kasei Co., Ltd.
- Udajari, S. (1996a). Ethylene Oxide. *The Merck Index*. Whitehouse Station N.J.: Merck & Co., Inc. 647.
- Udajari, S. (1996b). "Propylene Oxide." *The Merck Index*, White House Station, Merck & co., p.1349.
- Van Nispen, J. G. M. and Olivier, A. P. C. (1989). Preparation of Sugars of Non-reducing Sugars and One or More Fatty Acids by Transesterification Using a High Shear Mixing Device. HCAPLUS 111:134688. Europe EP 315265 A!, Cooperative Vereniging Suiker Unie U. A.
- Wagner, F. W. et al. (1990). Preparation of Sugar Fatty Acid Esters Having a Degree of Polymerization up to 2. U.S. 4,927,920, Nebraska Dept. of Economic Development.
- Waldinger, C. and Schneider, M. (1996). Enzyme Esterification of Glycerol III L Lipase-catalyzed Synthesis of Regiomeric Pure 1,3-sn-Diacylglycerols and 1,3-rac-Monoacylglycerols Derived from Unsaturated Fatty Acids. *J. Am. Oil Chem. Soc.* **73**(11): 1513–19.
- Wang, X. G. et al. (1997). Synthesis of Phosphatidylglycerol from Soybean Lecithin with Immobilized Phospholipase D. *J. Am. Oil Chem. Soc.* **74**: 87–91.
- Wilson, D. C. (1999). Continuous Process for the Synthesis of Sucrose Fatty Acid Esters. U. S. 5,872,245, Optima Technologies Group.
- Woods, G. E. (1961). U.S. 3, 012, 047.
- Yamane, T. et al. (1984). Continuous Synthesis of Glycerides by Lipase in a Microporous Membrane Bioreactor. *Ann. N. Y. Acad. Sci.* **434**: 558–68.

Chapter 3

Analysis of Food Emulsifiers

Gerard L. Hasenhuettl

Analytical methods used to measure food emulsifiers are derived from lipid analysis (Firestone, 2001; Otles, 2004; Wood et al., 2004; Byrdwell, 2005a). Test Methods are of several types and are carried out for several reasons. Food additives are regulated by government agencies to ensure health and safety. Specifications may be set for starting materials, products, processing methods, and maximum use levels in foods. Tests may also be necessary to ensure the absence of degradation products, microorganisms and foreign materials. Composition of emulsifiers may be related to their functional performance in finished foods. Nongovernmental specifications for food emulsifiers may be negotiated between the supplier and the customer, usually a processed food producer. Tests may be carried out in the manufacturer's processing line or control laboratory, after which the manufacturer may issue a certificate of analysis. The customer may check the analyses as part of the receiving process, and accept or reject the shipment. Disputes may be submitted to an independent testing laboratory for resolution. Standardized test methods have been developed by professional societies, such as, the Association of Official Analytical Chemists (AOAC) (Horvitz, 2005), the American Oil Chemists Society (AOCS) (Firestone, 2005a), the International Union of Pure and Applied Chemistry (IUPAC) (Paquot and Hauffen, 1987), Leatherhead Foods Research Association, and the National Academy of Sciences (Food Chemicals Codex) (Codex, 2004).

To determine emulsifiers in intact food products, fats and emulsifiers must first be extracted. Fats and oils are soluble in nonpolar solvents, such as hexane and toluene. However, emulsifiers are amphiphilic and therefore, less soluble, particularly when emulsifier concentration is high compared to total lipid. Chloroform and chloroform/methanol have been effective for extraction of emulsifiers (Flor and Prager, 1980). Because these solvents are classified as hazardous waste, provisions should be made for recycling. In cases where the lipid concentration is high relative to emulsifier concentration, extraction with hot hexane, followed by acetonitrile was reported (Halverson and Qvist, 1974). Solid samples (e.g., cakes or powdered coffee whiteners) may be conveniently extracted in a Soxhlet extraction apparatus. Liquid samples (e.g., milk or ice cream mix) are generally extracted in a separatory funnel or countercurrent distribution apparatus. Another factor complicating extraction is that emulsifiers may be tightly complexed with starches or proteins, or may be encapsulated in a biopolymer matrix. Pretreatment with amylase enzyme may overcome this problem (Jodlbauer, 1976).

3.1 Thin Layer and Column Chromatography

After lipids have been extracted from the food matrix, emulsifiers may be separated by simple thin layer or column chromatography. For example, on a silica gel column, triacylglycerols may be eluted with hexane. 5% Diethyl ether in hexane may be used to elute diacylglycerols, followed by elution of monoacylglycerols with 10% diethyl ether in hexane (Firestone, 2005b). A silver-impregnated Celite column was reported to accomplish this separation with a single solvent system (Dieffenbacher et al., 1988; Dieffenbacher et al., 1989). The isolated fractions may be quantitated gravimetrically, or may be subjected to further analytical techniques.

Thin layer chromatography (TLC) and paper chromatography have been used to identify food emulsifiers (Wyrziger, 1968; Murohy and Grislet, 1969; Murphy and Hibbert, 1969; Murphy and Scott, 1969). Samples may be spotted on a plate, coated with an adsorbent, such as silica, alumina, or florisil. Spots may be visualized by spraying with dichlorofluorescein and viewing under an ultraviolet light. Plates already containing a fluorescent indicator are commercially available. Spots are identified by their R_f values. A quantitative method has been developed which carries out the chromatographic separation on a coated rod, rather than a plate. The dried rod is placed in a scanning flame-ionization detector and peaks are recorded on an x-y plot. These methods are simple, rapid, economical, and reasonably reliable. One major disadvantage is that molecules having similar R_f values to compounds of interest will obscure the results. Preparative thin-layer chromatography has been used to separate lipids from foods for further analysis by gas-liquid chromatography (Paganuzzi, 1987).

Mono- and diacylglycerols are readily separated on a boric acid-impregnated silica gel plate. A petroleum ether/diethyl ether/acetic acid solution has been used to separate monoacylglycerols from alimentary pastes (Schmid and Ottender, 1976). A chloroform/acetone mixture was used to separate monoacylglycerols from propylene glycol esters of fatty acids (Kanematsu et al., 1972). Quantitative determinations have been achieved using a coated rod and a flame ionization detector (Regula, 1975; Takagi and Itabashi, 1986).

Because of their importance in lipid metabolism, and their functions in membrane structures, phospholipids have received a great deal of attention in lipid analysis. Many TLC methods have been reported for these lipid derivatives from animals and oilseeds (Erdahl et al., 1973; Vyncke and Lagrou, 1973; Kimura et al., 1969; El-Sebaïy et al., 1980; Lendrath, 1990; Biacs et al., 1978). A 2-dimensional procedure on silica gel plates separated phospholipids using acidic and basic solvents (Watanabe et al., 1986; Firestone, 2005c). The method was used to separate constituents of soy and egg lecithins. Detection of compounds in this class may be done with a conventional spray, such as sulfuric acid or dichlorofluorescein. However, phospholipids may be distinguished from other lipids by using selective reagents or spectroscopic detection (Senelt et al., 1986; Duden and Fricker, 1977). Quantitative detection on a silica rod has also been reported (Tanaka et al., 1979). Experimental design has been reported to be a useful tool to optimize separations of phosphorous

containing lipids (Olsson et al., 1990). Since phospholipids occur at low concentrations in biological samples, TLC has largely been replaced by more sensitive methods. High performance liquid chromatography (HPLC), mass spectrometry (MS), and their combination (HPLC/MS) will be discussed later in this chapter.

Monoacylglycerols may be modified by reaction with organic acids (see Chap. 2) to form molecules having unique functionality. TLC can be used to monitor the progress of the reactions and analyze the composition of the final product (Brummer, 1971; Yusupoca et al., 1976; Judlbauer, 1981). Specifically, succinylated and lactylated (Shmidt et al., 1976) as well as DATEM surfactants have been analyzed.

Molecules with multiple esterification sites and/or polymeric head groups present a formidable challenge analytical. These tests generally involve a titration. For example, free fatty acid may be titrated with a standard alkali. Kieselgel G TLC plates using a hexane/acetone/acetic acid solvent system (Regula, 1975). Spots were visualized by spraying the plate with bromocresol green. Sucrose esters of fatty acids have been characterized by TLC (Li et al., 2002), and rod-TLC/flame-ionization.

3.2 Wet Chemical Analysis

The earliest methods used for analysis of fats, oils and their derivatives were wet chemical procedures, that is, they involve solvents and chemical reactions. These tests generally rely on a titration or colorimetric determination. For example, free fatty acid may be titrated with a standard alkali in alcohol solution. Wet chemical methods are time-tested, simple, and require relatively inexpensive equipment. On the other hand, they are labor-intensive and require disposal or recycling of large quantities of solvent. A number of these methods are being replaced by instrument tests, which use autosampling, digital data collection, and, much less solvent.

3.2.1 α -Monoacylglycerol (α -Monoglyceride)

Synthesis of monoacylglycerols (see Chap. 2) yields an approximately 90:10 ratio of α - and β -isomers. α -Monoacylglycerol has a single fatty acid esterified to the sn-1 or sn-3 (primary) positions of the glycerol backbone. The β -isomer has the fatty acid esterified at the sn-2 (secondary) position. Therefore, the statistically random distribution theory would predict a 2:1 ratio. The variation may be rationalized by the lower steric repulsion in the α -isomer.

α -Monoacylglycerols have adjacent (vicinal) free hydroxyl groups at the sn-1,2 or sn-2,3 positions of the molecule. Reaction with periodic acid causes cleavage of the chain between the vicinal hydroxyl groups (Fig. 3.1). Standard analytical procedures are based on this reaction (Firestone, 2005d). The surfactant is reacted with an excess of periodic acid in a methanol solution. Potassium iodide is added and the

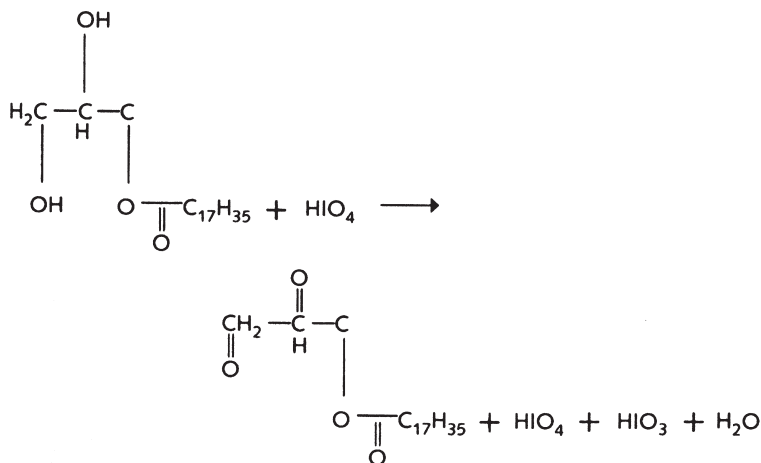

Fig. 3.1 Cleavage of Vicinal diols by periodic acid

liberated iodine is titrated with a standardized arsenite solution. In order to correct for the presence of free glycerol, a sample is extracted and the glycerol is determined (Firestone, 2005e). The wet method is not suitable for samples which contain other molecules with vicinal hydroxyl groups, or when the concentration of monoacylglycerol is <15%.

Since the majority of monoacylglycerol occurs as the α -isomer, this test has been accepted over time as a quality control specification. Due to problems with solvent disposal, the method has largely been replaced by gas-liquid chromatography, which provides a measurement for total monoacylglycerol ($\alpha = \beta$).

3.2.2 Acid Value/Free Fatty Acid

Fatty acids are used as starting materials in the preparation of surfactants by direct esterification (see Chap. 2). During interesterification, a small amount of fatty acid may be split off by the catalyst as soap. After neutralization, the resulting free fatty acid is retained in the product. Since fatty acids affect functionality in a number of applications, its concentration must be analyzed.

The acid value is determined by dissolving a weighed sample of the surfactant in a solvent and titrating with standard potassium hydroxide to a phenolphthalein end point (Firestone, 2005f). In cases where the method is used to monitor the reaction of acetic anhydride (DATEM or acetylated monoacylglycerols), an aprotic solvent system must be used to prevent anhydride reaction with alcohol. Potentiometric titration to an equivalence inflection point may also be used.

This approach is particularly useful for dark-colored samples where a visual end point may be difficult to observe. Acid value is defined as the number of milligrams of potassium hydroxide required to neutralize the acid in one gram of sample, and is calculated by the formula:

$$\frac{(A - B)N}{W(56.1)}$$

A = ml KOH solution to neutralize the surfactant sample

B = ml KOH solution to neutralize a blank sample

N = normality of KOH solution

W = wt. of sample in g, and 56.1 is the molecular wt. of KOH

The percentage of free fatty acid is determined by dividing the acid value by a factor, characteristic of the fatty acid present (Firestone, 2005g). For example, C12 (lauric) = 2.81, C16 (palmitic) = 2.19, and C18 (stearic or oleic) = 1.99. The method is not applicable to samples containing other mineral or organic acids.

3.2.3 Iodine Value (IV)

The fatty acids, used to prepare surfactants, may contain saturated or unsaturated alkyl chains. Since unsaturated chains pack differently in crystalline and polymorphic forms, substantial differences in functionality may be observed with variation in unsaturated content. Unsaturated chains are also vulnerable to oxidative degradation.

Reagents, which add across carbon-carbon double bonds, have been used to determine degree of unsaturation since the early years of organic chemistry. Two commonly accepted methods have been developed: (1) The Wijs Method (Firestone, 2005h) reacts iodine monochloride with a surfactant in carbon tetrachloride. Excess reagent is then titrated with standard thiosulfate solution. (2) The Hanus Method is nearly identical but employs iodine monobromide as the reagent. Because of the high toxicity of carbon tetrachloride, a modified method has been developed which uses cyclohexane as the solvent (Firestone, 2005i). Iodine Value is defined as the number of centigrams of iodine absorbed per gram of sample (same as the wt. % of iodine absorbed). The following formula is used to calculate the iodine value:

$$\frac{12.6N}{(S - B_0)W}$$

S = ml solution to titrate the sample

B = ml solution to titrate a blank

N = normality of the thiosulfate solution

W = weight of the sample

When reporting the iodine value, it is important to include the test method which was used. Instrumental methods, such as gas-liquid chromatography and infrared spectroscopy, have been developed to measure the iodine value.

3.2.4 Peroxide Value (PV)

As mentioned in the previous section, surfactants containing unsaturated fatty acids are vulnerable to oxidative degradation (rancidity). The initial stage of the oxidative chain reaction is insertion of oxygen into a carbon-hydrogen bond to form a hydroperoxide. Surfactants which have been bleached, such as sorbitan monostearate or sodium stearyl lactylate, may contain residual peroxides. These species represent potential oxidative rancidity to finished food products.

Peroxides and hydroperoxide are determined by treating a weighed sample with an excess of potassium iodide in acetic acid/chloroform solution (Firestone, 2005j). Because of the toxicity and carcinogenic potential of chloroform, a method was developed using isooctane as an alternative (Firestone, 2005k); Iodine which is liberated by the reaction, is titrated with standard thiosulfate solution to an endpoint with a starch indicator. Precautions must be taken to ensure that glassware is free from residual oxidizing or reducing agents. Strong ultraviolet light must be avoided because of its tendency to promote photochemical oxidation. Peroxide value is defined as the number of milliequivalents of peroxide (AOAC uses the term “active oxygen”) per kg. of sample. It is expressed in the formula:

$$\frac{1000(VT)}{M}$$

V = volume of titrant

T = normality of thiosulfate solution

M = weight of sample in g.

Recently, high performance liquid chromatography (HPLC) was used to determine peroxide.

3.2.5 Saponification Value

As with any other carboxylic acid ester, cleavage of the ester bond may be induced by reaction with alkali and water to produce an alcohol and the salt of the carboxylic acid. This reaction is known as saponification. The saponification value is defined as the number of milligrams of potassium hydroxide required for reaction of one gram of sample (Hummel, 2000a; Firestone, 2005l). A weighed sample is reacted with an alcoholic potassium hydroxide solution and excess alkali is titrated with standard hydrochloric acid solution to a phenolphthalein end point. Alternatively, a potentiometric titration may be used when a visual end point is difficult to observe. Saponification is calculated using the formula:

$$\frac{56.1N(B-S)}{W}$$

B = ml required to titrate a blank

S = ml required to titrate the sample

N = normality of the reagent, 56.1 is the molecular weight of KOH

W = wt of the sample in g

When comparing triacylglycerols, saponification value is a measure of fatty acid chain length. Shorter chains give higher values while longer chains produce lower values. For surfactants, the saponification value is sensitive to both the chain lengths of the fatty acids present and the degree of substitution. Shorter fatty acid chains and higher degrees of substitution produce higher saponification values. Conversely, longer fatty acids and lower degrees of substitution will give lower saponification values.

3.2.6 Hydroxyl Value

When polyols are esterified to produce surfactants, some hydroxyl groups are left unesterified. These groups may be determined by reaction with acetic anhydride in the presence of pyridine. The reacted sample is then treated with water and heated to hydrolyze excess anhydride to acetic acid. The acetic acid is then titrated with standard alkali with an indicator to determine the end point. The hydroxyl value is defined as the number of milligrams of potassium hydroxide equivalent to the hydroxyl content of one gram of sample (Hummel, 2000b; Firestone, 2005m). It is calculated using the formula:

$$\frac{56.1T(V_0 - V)}{M} + AV$$

T = normality of KOH titrant, 56.1 = mol. wt. of KOH

V_0 = ml required to titrate a blank

V = ml to titrate the sample

M = wt. of sample in g

AV = acid value of sample

As a measure of hydroxyl groups in a surfactant, the hydroxyl value is an indicator of the hydrophilic character. Higher hydroxyl values are correlated with higher HLB values.

The reaction/titration procedure is time consuming and requires a great deal of skill on the part of the analyst. Minor variations in the method may cause large discrepancies in the results. It is therefore recommended that the hydroxyl value should be determined as an average of duplicate samples. Efforts have been made to correlate hydroxyl values to instrumental methods, such as near infrared reflectance spectroscopy.

3.2.7 *Lactic Acid Analyses*

Lactic acid is used in the manufacture of surfactants, such as lactylated monoacylglycerols or propylene glycol esters, sodium stearoyl lactylate (SSL), and calcium stearoyl lactylate (CSL). Lactic acid in these products occurs in two forms: free and esterified. Total lactic acid content is the sum of these forms. Lactic acid is a bifunctional molecule which can self-condense to form polylactic acid.

Total lactic acid has been determined by reaction of a weighed sample with alcoholic potassium hydroxide, neutralization with hydrochloric acid, extraction with diethyl ether, and titration with standard potassium hydroxide.

Free and polylactic acid and water insoluble combined lactic acid (WICLA) are determined by dissolving a weighed sample in benzene. The aqueous extract is titrated with potassium hydroxide to determine the free acid. The upper benzene layer is dried and the sample reacted and titrated in the same manner as for total lactic acid. Two problems with the above methods are the laborious extraction/phase separations and the use of carcinogenic benzene. A modification of the method uses a chloroform/petroleum ether solvent for the determination of lactic, citric, and tartaric acids (Franzke, 1977). The same authors demonstrated that enzymatic, rather than potassium hydroxide, could be used for the cleavage reaction in determination of total lactic acid (Franzke and Kroll, 1980).

3.2.8 *Reichert-Meisel Value*

Some fats and oils, such as butter and coconut, contain short chain fatty acids (C4-C10). The Reichert-Meisel method was developed to determine the content of these acids (Firestone, 2005n). The method has been applied to determination of acetic acid esterified to monoacylglycerols and tartaric acid esters of monoacylglycerols.

A weighed sample is hydrolyzed in alkali solution, followed by neutralization with dilute sulfuric acid. Liberated acetic acid is distilled and titrated with standardized alkali to a phenolphthalein end point. The method is equipment intensive, since the distillation apparatus must be replaced or cleaned between analyses. The distillation step is also time consuming.

3.2.9 *Moisture*

The presence of moisture in food surfactants is generally undesirable. It affords the opportunity for microbial growth and may cause ester cleavage to produce free fatty acids (hydrolytic rancidity). Surfactants may become contaminated by pumping through inadequately dried lines. In solid products, moisture may be picked up in flaking and spray chilling, especially in high humidity environments. There are two

cases where water is deliberately added: (1) in polysorbates, where a small amount of water is needed to prevent phase separation; (2) surfactant gels, which enhance functionality in specific applications.

Older methods relied on gravimetric techniques to determine water loss from a sample after heating. These methods were unable to distinguish between water and other volatile components. Another method dissolves a large sample in toluene and distills water and toluene into a graduated separation tube. Water is quantitated by volume. The method is best suited to samples where the water content is $>0.5\%$. It is also equipment intensive and time consuming. Titration with Karl Fischer reagent ($\text{SO}_2/\text{I}_2/\text{pyridine}/2\text{-methoxyethanol}$) has been developed for determination of commercial fats and oils (Firestone, 2005o), industrial oil derivatives (Firestone, 2005p), and lecithin (Firestone, 2005q). Autotitrators are available which can process large numbers of samples without the need for cleaning between samples. Some impurities, such as peroxides, can react with Karl Fischer to give high results. Near infrared spectroscopy has been used to determine moisture in raw materials.

3.2.10 Fatty Acid Soaps

Sodium and calcium salts of fatty acids (soaps) are formed in food surfactants by the use of alkaline catalysts in the manufacturing process. Inadequate neutralization at the end of the reaction results in residual soap. Residual alkalinity can result in degradation due to disproportionation reactions, especially during molten storage.

One analytical method consists of dissolving a weighed sample in organic solvent/water mixture and titration with a standard hydrochloric acid solution (Firestone, 2005r). Although the scope of the official method is limited to refined vegetable oils, the procedure may be adapted for surfactants. Bromophenol blue or phenolphthalein may be used as an indicator. The method may also be adapted for potentiometric titration. An alternative method to determine whether a product has been neutralized is to measure the pH. A 5% solution of the surfactant is allowed to equilibrate to ambient temperature and the pH is measured with a standard electrode. Values in the range of 6.5–6.8 indicate the absence of soap and proper neutralization of the product.

3.2.11 Phosphorus and Phospholipids

Soy lecithin is a widely used food surfactant derived from soybean oil refining. Structurally, phosphoric acid is esterified to a diacylglycerol and to an organic base or inositol. Monoacylglycerol phosphate has a similar structure. One way to determine the concentration of these surfactants is to analyze for phosphorous, and then apply a gravimetric factor. A titrimetric method saponifies a sample, followed by precipitation with molybdate solution. The precipitate is washed and dissolved in

an alkali solution. Excess alkali is then titrated with standard acid. Another method involves ashing a sample, dissolving the ash in acid, and determining the phosphorus colorimetrically with molybdate (Firestone, 2005s). A simpler, albeit less precise, approach is to precipitate the phospholipid in acetone. The precipitate is dried and the insoluble content determined by weight. Acetone-insolubles can also be determined by turbidity measurement (Goldstein, 1984).

Because of the importance of phospholipids in lipid metabolism and membrane structure, a great deal of effort has been expended to develop new quantitative methods. Techniques, such as spectrophotometry, thin layer chromatography (TLC), high performance liquid chromatography (HPLC), mass spectrometry (MS), and HPLC/MS, are discussed elsewhere in this chapter.

3.3 Measurement of Physical Properties

Physical properties of food surfactants often play a critical role in the appearance, texture, and flavor release in finished food products. Chapter 6 will discuss the physical properties of food emulsifiers in greater detail. In this section, we will survey some common methods for measuring physical properties.

3.3.1 Color

Although color may be considered a physical property, its origin arises from the chemical composition of the starting lipids. Fats and oils contain minor components such as tocopherols, carotenoids, and chlorophyll. These compounds are removed during processing but may be “locked in” if the fat/oil has been thermally abused. Side reactions during manufacture may also lead to dark colors. For example, carrying out the reaction at high temperature can cause caramelization of sucrose. Dark colors may not only cause a defect in the appearance of foods but may also be an indicator of other problems, such as oxidation. The lightest possible color is therefore a quality goal. Since most colors originate in fat/oil starting materials, strict receiving guidelines must be developed.

Color determination is most often performed by comparison of a sample to a set of standards, such as colored glasses. A widely used method in the oil processing industry is the Lovibond method (Firestone, 2005t), also referred to as the Wesson Method (Firestone, 2005u). A column of liquid (or molten) sample in a glass tube is observed over a white background and compared to a set of colored glasses. Values are determined for red (R) and yellow (Y), which arise from minor constituents in vegetable oils. A related test is the Gardner method (Firestone, 2005v). This procedure is used for lecithin and industrial oils and reports a single number for color. Another comparative test, the FAC method (Firestone, 2005w), is applied to samples

too dark to be read by the other methods. Photometers and spectrophotometers have been used to determine colors in the UV-visible range (Firestone, 2005x). These methods are objective, noncomparative determinations, which are also useful for quantitation of other colors (for example, green arising from chlorophyll).

3.3.2 Refractive Index

Clear liquids refract light because of the differences in the speed of light in different media. Refractive index is the ratio of the speed of light in air to the speed of light in the liquid. Measurements are carried out in a refractometer (Firestone, 2005y). It is commonly used as a rapid method to monitor chemical reactions. The measurement is correlated to a chemical property, such as iodine or hydroxyl value. For example, in the polymerization of glycerol, the refractive index increases with the degree of polymerization. Determination of the end point is quickly determined by refractive index and confirmed later by hydroxyl value.

3.3.3 Melting Point

Fats, oils and their derivatives are heterogeneous compositions and do not display sharp melting points as do pure, homogeneous compounds. Rather, a broad melting range is observed. To further complicate the situation, polymorphic crystals may melt and recrystallize into a different polymorphic form. However, melting behavior is often critical to functionality in foods. For example, the melting point of a peanut butter stabilizer must be matched to the filling temperature to prevent oil separation. This poses a significant challenge of melting behavior as a quality measurement. A number of methods have been developed to describe the melting behavior of fat based ingredients in diverse food applications.

Capillary melting points have been common methods for organic compounds. For fats and surfactants, the melting range needs to be converted to a single number. The definition of capillary melting point has been defined as the temperature at which the sample becomes completely liquid or clear (Firestone, 2005z). This end point is difficult to observe if the sample contains suspended inorganic or dark colored matter. For such samples, the slip point (also known as the softening point) (Firestone, 2005aa) is a more useable method. In this test, a sample in an open capillary tube is heated at a programmed rate and the melting point is defined as the temperature at which the sample slips out of the tube. This method will give a lower value than the standard capillary method because it measures the onset of melting. When reporting melting points, it is critical to report the method used. The dropping point (Firestone, 2005ab) is obtained in an instrument which heats a solid

sample disk at a programmed rate. At the melting point, the sample drops through a detection system and the temperature is recorded. This method does not rely on observation and judgment of an operator.

3.3.4 Viscosity

Viscosity is a physical property of food emulsifiers, which is important to transfer, such as pumping through pipelines. It is generally used as a control measure for viscous liquids, such as polyglycerol esters. The property is temperature dependent: viscosity decreases as temperature increases. Products may need to be heated in order to be pumped through heat-traced pipes.

The viscosity of lecithin and other viscous liquids may be measured by a procedure known as the “bubble-time method.” A sample is poured into an ASTM tube in a constant temperature bath (Firestone, 2005ac). The tube is inverted and the time required for the bubble to reach the top is recorded. This value is converted to viscosity by comparison to a calibration curve constructed from authentic standards. Viscosity may also be measured directly with a Brookfield viscometer (Firestone, 2005ad). This technique is preferred when samples are not clear liquids.

3.3.5 Specific Gravity

Specific Gravity is measured for cases where weight and volume need to be converted. For example, a batch recipe may specify a weight of a liquid ingredient. If the ingredient is pumped through a mass flowmeter, the weight must be converted to volume. Specific gravity is also important in specifying the volume of a package required to hold a specified weight of emulsifier. Specific gravity is measured in a pycnometer at 25 °C if the sample is liquid at ambient temperatures. 40 °C or 60 °C may be required for higher melting materials (Firestone, 2005ae). A method is also available for measuring the specific gravity of solids (Firestone, 2005af). Air bubbles must be carefully removed in order to obtain accurate values.

3.4 Instrumental Methods of Analysis

Advances in analytical chemistry have enabled the development of sophisticated instruments that may be applied to analysis of lipids. Instrumental methods have several advantages over wet chemical titrations: (1) More detailed information about composition and structure; (2) Less waste disposal and solvent recovery; (3) Automation of sample introduction and data archiving; in some instances, more

rapid results. The greatest obstacle to widespread adoption of instrumentation in the food industry is the high initial cost of equipment.

3.4.1 Gas-Liquid Chromatography (GLC)

Gas-liquid chromatography separates a stream of vaporized sample in a heated column packed with an absorbent. Detection of eluting peaks may be accomplished using thermal or flame ionization detectors. A mass spectrometer may also be used in combination with GLC to provide structural information for each peak (GC/MS). Application to lipids is difficult because of their low volatility. High temperatures or reaction to prepare volatile derivatives have been used to overcome this problem.

The most common GLC method is the determination of fatty acid composition. Fatty acids are cleaved from their polyol backbone, followed by reaction to form a more volatile derivative, such as a methyl ester (Firestone, 2005ag). The sample is injected into the GLC and separated on a packed or capillary column. The chain length of the fatty acids and the degree of unsaturation determines separation. Retention times of the peaks are recorded and correlated to previously analyzed internal standards. Concentrations are determined by peak height or area, corrected by the response factor for each peak.

Mono- and diacylglycerols are the simplest food emulsifiers compositionally. GLC analysis is accomplished by reaction of a dry sample with chlorotrimethylsilane and hexamethyldisilazane in the presence of pyridine (Nakanishi and Tsuda, 1983; Brueschweiler and Dieffenbacher, 1991; Firestone, 2005ah). GC/MS analysis has also been reported (Lee, 1988). The method may also be used to analyze mixtures of propylene glycol esters and monoacylglycerols. Figure 3.2 shows a

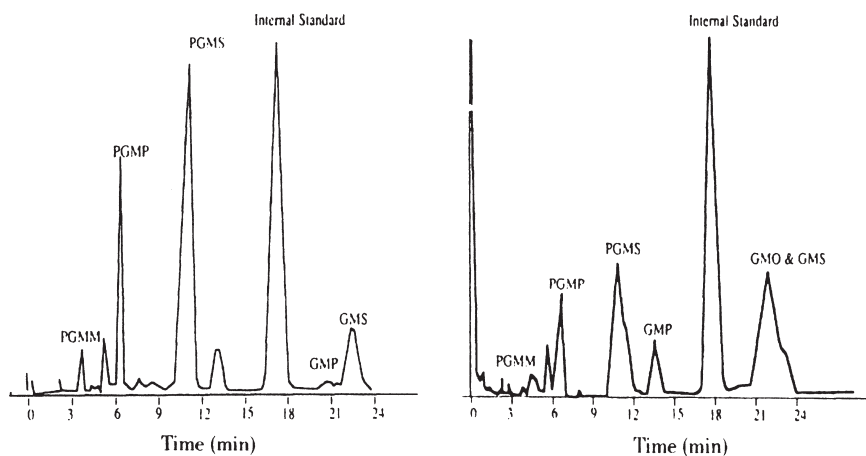

Fig. 3.2 GLC separation of monoglycerides and propylene glycol ester emulsifiers. (a) Commercial emulsifier; (b) in shortening. (Hasenhuettl et al., 1990.)

separation of such a mixture. Eluted peaks are quantitatively determined by reference to an internal standard. Monoheptadecanoylglycerol (monomargarin) has historically been used as a standard. However, it is expensive, difficult to synthesize and solutions are not stable over time. (\pm)-Batyl alcohol has been suggested as an alternative (Hasenhuettl et al., 1990). It is a commercially available glyceryl ether having the same molecular weight as monomargarin. The ether linkage makes it stable to disproportionation. Cholesteryl acetate has also been recommended.

Polyol distributions of food surfactants may be determined by cleavage of the fatty acids by saponification, followed by analysis of the polyol fraction. If the polyol is not sufficiently volatile or unstable at high temperatures, they may be converted to trimethylsilyl ethers. For example, sorbitol, sorbitan and isosorbide, cleaved from sorbitan mono- or tristearate, can be determined by GLC (Murphy and Grislett, 1969; Tsuda et al., 1984). Glycerol through dodecaglycerol, obtained from polyglycerol esters, may be determined using their volatile derivatives (Schuetze, 1977). Supercritical fluid chromatography (Macka et al., 1994) and a combined GLC/HPLC method (DeMeulenaer et al., 2000) have been used to obtain polyglycerol distribution. Reaction and high temperature gas chromatography have determined polysorbates

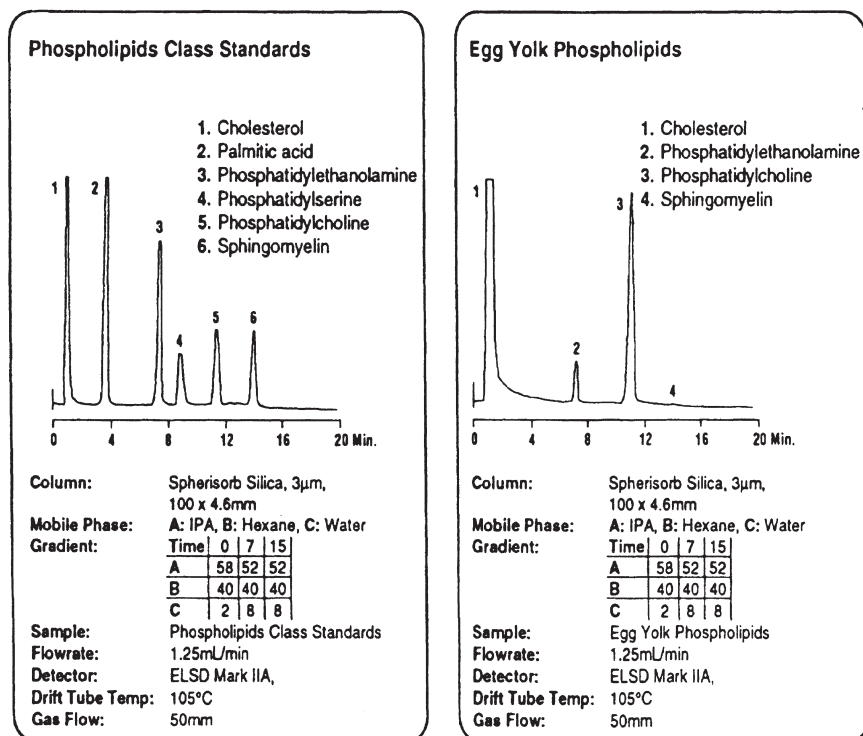

Fig. 3.3 HPLC separation of phospholipids using an evaporative light-scattering detector. (Courtesy of Alltech Associates, Inc.)

(Lundquist and Meloan, 1971; Kato et al., 1989). Although sucrose and fatty acid esters of sucrose decompose at high temperatures, they have been analyzed by GLC (Karrer and Herberg, 1992). Addition of mass spectroscopy confirms the eluted peaks and is a source of additional information (Uematsu et al., 2001). GLC is also a valuable tool for the detection of contaminants, such as heat exchange fluids (Firestone, 2005ai).

3.4.2 High Performance Liquid Chromatography (HPLC)

HPLC is a logical extension of column chromatography. It is a very useful technique for lipid derivatives, since the sample does not need to be converted to a volatile derivative. A sample is injected onto a column and a carrier solvent carries it through. Recently, column diameters have been made very small to minimize the amount of solvent. The nature of the column determines the mode of separation. A standard column, for example silica gel, separates compounds by adsorption of the polar groups. Nonpolar (reverse phase) columns, such as polystyrene cross-linked with divinylbenzene, adsorb lipophilic regions of the molecule. When both techniques are used in a single sample, complementary information is often obtained. A size exclusion column separates compounds by shape and molecular weight.

One problem encountered with HPLC analysis of lipids is their poor response to conventional detectors. Saturated lipids do not absorb UV light at a unique region of the spectrum. A refractive index (RI) detector may be used, but it is less sensitive and limited to an isocratic (single solvent) system. An evaporative light scattering detector (ELSD) has been developed to overcome these problems (Christie, 1992; Hammond, 1993; Bruns, 1988; Lee et al., 1993). Solvent is flashed off in the detector and the residual nonvolatile matter scatters light and is recognized as a peak. Figure 3.3 shows a separation of phospholipids using this detector.

Perhaps the most commonly reported separations by HPLC have been monoacylglycerols (Filip and Kleunova, 1993; Takagi and Ando, 1994; Ranger and Wenz, 1989; Tajano and Kondoh, 1987; Martin et al., 1989; Rilsom and Hoffmayer, 1978; Brueschweiler, 1977; Firestone, 2005aj) and phospholipids (Christie, 1996; Melton, 1992; Sotirhos et al., 1986; Hurst and Martin, 1984; Huyghebaert and Baert, 1992; Tumanaka and Fujita, 1990; Rhee and Shin, 1982; Hsieh et al., 1981; Kaitaranta and Bessman, 1981 p. 5; Firestone, 2005aj; Luquain et al., 2001). Free glycerine may also be determined by HPLC (Firestone, 2005ak).

Polyglycerol mono- and polyesters have been separated by HPLC on a Li-Chromasorb column (Garti, 1981; Kumar et al., 1984). Sorbitan esters of fatty acids have also been separated on the same stationary phase (Garti and Ascerin, 1983). Sucrose esters of fatty acids were determined using their 3,5-dinitrobenzyl derivatives (Murakami et al., 1989). Determination of propylene glycol alginate in aqueous systems has been accomplished by high performance anion exchange chromatography (Diepenmaat-Walters et al., 1997). Contamination of lipid derivatives with heat exchange fluids can be detected by HPLC (Firestone, 2005al).

3.4.3 *Mass Spectrometry (MS)*

Mass spectrometry has been a powerful tool for structural determination of organic molecules. Molecular, or parent ions, indicate the molecular weight of the molecule. Fragmentation of the molecule produces daughter ions, which provide evidence of substructure and functional groups. Tandem mass spectrometry allows both molecular and daughter ions to be resolved in a single determination. Progress in lipid analysis using MS has been hindered by two factors: (1) Lipids are nonvolatile and not amenable to injection into high-vacuum instruments, for example, electron impact MS, (2) Commercial lipids are complex mixtures which produce a bewildering array of molecular and daughter ions. Development of a variety of ionization methods and the combination with HPLC has led to encouraging results. However, the high capital cost of these instruments currently limits their use to research.

Soft atmospheric pressure ionization methods, such as atmospheric pressure chemical ionization (APCI), atmospheric pressure photo ionization (APPI) (Cai and Syage, 2006) electrospray ionization (ESI), and matrix-assisted laser desorption ionization (MALDI), have enabled the characterization of lipids (Byrdwell, 2005b). ESI is useful for polar lipids over a fairly wide range of molecular weights. Low molecular weight nonpolar lipids are more amenable to APPI. In an emerging field, known as lipidomics, a complex mixture of lipids can be directly injected into a mass spectrometer, and characterized by a wide variety of ionization methods (Ham and Gross, 2005). Phospholipids are distinguished from other lipids using their lithium salts and the nitrogen rule.

Fast atom bombardment (FAB) was used to characterize the phospholipids in egg yolk (Trautler and Nikiforov, 1984). Protonated molecular ions (MH⁺) were easily resolved and identified. Polysorbates in foods were characterized by negative ion MS (Daniels et al., 1985). Two families of peaks were recognized: free polyoxyethylenes and polyoxyethylenes esterified to sorbitans. Fatty acids esterified to sorbitans could also be identified in the spectra. MALDI time-of-flight MS was also reported as a method for analysis of polysorbates (Frison-Norrie, 2001). Sucrose esters of fatty acids were analyzed by ESI/MS (Schuyf and van Platerink, 1994). This technique showed a family of molecular ions corresponding to degree of esterification of fatty acids to sucrose.

3.4.4 *High Performance Liquid Chromatography/Mass Spectrometry*

Integration of HPLC/MS has been difficult due to the necessity for removal of large volumes of solvent prior to MS analysis. Early efforts consisted of collection of peaks from the HPLC, evaporation of the solvent, and direct injection directly into the MS ionization source. Concurrent development of microbore columns and ionization techniques such as APCI and ESI, allowed the marriage of the two powerful

technologies. When ELSD, a destructive detector, is used, a split stream is diverted to the MS source. Normal phase HPLC, coupled with ESI tandem mass spectrometry (MS/MS), is useful for separation and characterization of complex phospholipid mixtures (Larsen and Hyattumff, 2005). Phospholipids are separated by head group class and molecular weights of class members were determined by MS. Additional detail could be obtained by collecting the fractions from normal phase HPLC, using reverse phase HPLC to separate class members, and find detailed structure by MS. Polyglycerol esters were separated by LC and their structures confirmed by MS (DeMeulenaer et al., 2000). In this case also, additional detail could probably be obtained by a combination of standard and reverse phase HPLC. Glycolipid biosurfactants have been characterized by HPLC/MS (Nunez et al., 2005). Because the head groups of these substances are large and complex, the methodology may be useful for high HLB surfactants, such as polysorbates, polyglycerol esters, and sucrose esters.

Because normal phase and reverse phase HPLC are orthogonal separation methods, coupling them both simultaneously to MS (HPLC-2/MS) has been developed as a useful technique for separation of complex lipid/phospholipid mixtures (Byrdwell, 2005c). APCI and ESI are also complementary techniques. Coupling of all four modalities (HPLC-2/MS-2) is capable of yielding enormous amounts of structural and compositional data simultaneously.

Although HPLC/MS is an extremely powerful tool, it is far too expensive for routine analysis for food surfactants. However, it will likely find use as a research tool in universities and large companies.

3.4.5 *Spectroscopic Methods*

As previously pointed out in our discussion of HPLC detectors, saturated lipids do not absorb light in any useful region of the UV/VIS spectrum. However, functional groups of surfactant molecules can form colored complexes with a number of reagents. Measurements of absorbance in a spectrophotometer can then be correlated with concentration of the surfactant. Anionic functional groups form complexes with methylene blue, which may be detected at 650 nm. Cationic surfactants react with Orange 2 to yield a complex detectable at 485 nm (Lew, 1975). A DTEM/meta-vanadate complex could be measured at 490 nm (Shmidt et al., 1979). Phosphatidylcholine in lecithins, can complex with methylene blue (Hartman et al., 1980), dipicrylamine (Mueller, 1977), or Reinecke's salt (Moelering and Bergmeyer, 1974), for spectrophotometric analysis. Total phosphorous can be determined through the phosphomolybdate complex (Firestone, 2005am). Polyoxyethylene chains can form colored complexes, which can then be determined spectrophotometrically (Kato et al., 1989). Polysorbates have been analyzed by this method in a number of food products (Daniels, 1982; Saito et al., 1987; Tonogau et al., 1987).

In contrast to the UV/VIS, the infrared spectrum has a number of wavelengths, which are diagnostic of functional groups found in surfactants. In particular, double

bond, carbonyl, and hydroxyl stretching bands have been used for qualitative and quantitative analysis. Infrared spectroscopy was used to confirm the identity of polysorbates determined by other methods (Kato et al., 1989). Near-infrared (NIR) determines the iodine value by correlation of double bond stretching bands with a calibration curve (Firestone, 2005an). NIR was also used as a rapid determination of hydroxyl value of polyglycerols and polyglycerol esters by measuring the –OH stretch (Ingber, 1986). Spectrophotometry may also be used to detect impurities in food surfactants and lipids. An alternative to peroxide value measures iodine liberated by reaction with peroxides (Yamanaka and Kudo, 1991). Residual dimethylformamide in sucrose esters has been determined by measurement of the absorption peak at 1675 cm^{-1} (Jakubaska et al., 1977). However, this technique is not sufficiently sensitive to detect impurities at the ppm level. NIR and Fourier transform (FT-IR) methods have the advantage of rapidly obtaining compositional informational data. This is an opportunity to monitor the progress of chemical and enzymatic reactions, for example, in the esterification of glycerol with fatty acids (Blanco et al., 2004). FT-IR is also useful for the determination of hydration (Pohle et al., 1997) bilayer geometry and metal ion binding strength (Grdadolnik and Hadm, 1993) of phospholipids.

Atomic absorption spectroscopy (AA) is useful for detection of metals in surfactants and lipids. Heavy metal contaminants, such as lead (Firestone, 2005ao), or pro-oxidants (iron, copper, chromium) (Firestone, 2005ap) can be detected. Other metal ions detected are sodium, calcium, magnesium, nickel, silicon, and cadmium (Firestone, 2005aq).

3.4.6 Nuclear Magnetic Resonance

Atoms having an odd atomic number, display a magnetic resonance, which is characteristic of their chemical environment. Measurements may be carried out by placing a dissolved sample in strong electromagnetic and radio frequency fields. The magnetic field is varied (swept) and peaks are recorded by a radio frequency detector. Peak positions are determined by atoms to which the nucleus is bonded. Splitting patterns are observed which indicate adjacent atoms with a magnetically susceptible nucleus. Wide-line (low resolution) NMR is frequently used to determine the solid fat content (SFC) of a sample (Firestone, 2005ar). This method is limited to shortenings and hard butters, which may contain food surfactants. Chemical shifts have been used to identify mesomorphic phases of surfactants in aqueous systems (Lindblom, 1996). Mesomorphic phases are discussed further in Chap. 6.

Proton (^1H) nuclear magnetic resonance is the oldest method applied to organic molecules. However, because of the large number of protons present on alkyl chains, it has limited utility in lipid analysis. Phosphatidylcholine content has been determined by measuring the choline protons at 3.3 ppm (Press et al., 1981; Kostelnik and Castellano, 1973). Measurement of the vinylic protons at 5.5 ppm has been proposed as an alternative to the titrimetric method for iodine value (Sheeley et al., 1986).

Table 3.1 ^{13}C chemical shifts (ppm) for some food surfactants

Surfactant structure	GI-1	GI-2	GI-3	N-CH ₃	O-CH ₃
Soy phosphatidylcholine	63.01	70.51	63.33	66.26	59.34
Egg phosphatidylcholine	62.94	70.63	63.78	66.62	50.32
Soy phosphatidylethanolamine	62.81	70.59	64.07	40.69	62.08
Egg phosphatidylethanolamine	62.81	70.55	64.07	40.59	62.13
1-Monoacylglycerol	65.04	70.27	63.47	–	–
1,2-Diacylglycerol	65.04	72.25	61.58	–	–
1-Propylene glycol monoester	69.46	66.13	19.2	–	–
2-Propylene glycol monoester	65.92	71.77	16.25	–	–
Propylene glycol diester	65.42	67.98	16.5	–	–
Monoacetylated monoacylglycerol					
A	62.07	72.89	61.40	–	–
B	63.00	68.19	65.26	–	–
Diacetylated monoacylglycerol	62.00	69.16	62.33	–	–

Chemical shifts of carbon (^{13}C) are sensitive to the presence of functional groups. For example, a carbonyl carbon will have a drastically different shift than a carbon in a methyl group. Since there are many fewer carbon than hydrogen atoms in lipids, spectra are less complex and easier to interpret (Gunstone, 1993). Chemical shifts for glyceryl and carbons were used to measure the levels of monoacylglycerols, diacylglycerols, and free fatty acids in olive oil (Sacchi et al., 1990). Regio- and stereoselectivity of monoacylglycerol, derived from enzymatic reactions, can also be established (Mazur et al., 1991). Chemical shifts for diagnostic carbon atoms for monoacylglycerols, propylene glycol esters, acetylated monoacylglycerols, phosphatidylcholine, and phosphatidylethanolamine are shown in Table 3.1. ^1H and ^{13}C NMR have been used to determine multilamellar phospholipids (Everts and Davis, 2000), polyglycerols (Istratov et al., 2003), and polysorbate 60 (Dang et al., 2006).

Phosphorous (^{31}P) NMR is a very useful technique for determining structure and concentration of phospholipids (Glonek and Merchant, 1996; Gillet et al., 1998). Since there is only one phosphorous per molecule, peak assignment is straightforward compared to ^1H and ^{13}C NMR. This is somewhat offset by the numerous phosphorous-containing molecules present in nature. Optimization of solvent systems for best resolution was reported (Bosco et al., 1997). Phospholipids in milk fat globule membrane have been characterized by ^{31}P NMR (Murgia et al., 2003).

3.5 Setting Specifications

The practice of setting analytical specifications for food ingredients may be a matter of custom, such as accepting the manufacturer's values, or it may be a carefully reasoned approach based on product functionality. When developing new products, or something similar to existing products, the first approach is usually acceptable, and even time saving. Manufacturers of food surfactants are knowledgeable in applying

their ingredients in a variety of processed foods. Sometimes, however, a food processor may develop a “new to the world” product, which has no analogy to a food in current commerce. In this case, a logical, databased approach is preferable.

The first step in product development is to determine the attributes which are critical to consumer acceptance. This is traditionally done by quality descriptor analysis (QDA), focus groups, and consumer panels. Ingredients which enhance these characteristics can then be tested. Before testing surfactants, the regulatory and label requirements must be examined. For example, does the product need to be “all natural” or Kosher? Is the proposed ingredient permitted in the new food product?

Once the attributes and ingredients have been identified, a statistical design should be developed to optimize desired attributes. Since ingredient interactions are well known (Gaonkar and NcPherson, 2005), the initial design should be full-factorial. Once any two or three factor interactions have been identified, a fractional-factorial design can be drawn up to reduce the number of experiments. Once an optimal surfactant system has been identified, the range of acceptable analytical constants, for example monoacylglycerol content, must be defined. These values, along with analyses for absence of contaminants, are written into a raw material specification.

The food processor and the surfactant supplier should confer to determine whether these specifications can be met consistently. A history of the supplier’s analytical results should fall in the range at least with 95% confidence. Failure to routinely meet these limits could result in returned surfactant shipments, production delays, or even product recalls. It may be necessary to re-visit the product design to develop a more robust product formulation.

Acknowledgments This chapter was composed with fond memories of Nate Ingber, who had an incredible talent for applying modern instrumental methods to practical analytical challenges. The author is indebted to Julia Hasenhuettl for her patience and her assistance with literature searches and manuscript preparation.

References

- Biacs, O. et al. (1978). *Acta Aloment Acad. Sci. Hung.* 7(3): 181–93.
- Blanco, M. et al. (2004). *Anal. Chim. Acta* 521(13): 143–8.
- Bosco, M. et al. (1997). *Anal. Biochem.* 245(1): 38–47.
- Bruemmer, J. M. (1971). *Brot Gebaeck* 25(11): 217–20.
- Brueschweiler, H. (1977). *Mitt. Geb. Lebensmittelunters. Hyg.* 68(1): 46–63.
- Brueschweiler, H. and Dieffenbacher, A. (1991). *Pure Appl. Chem.* 63(8): 1153–62.
- Bruns, A. (1988). *Fett Wiss. Technol.* 90(8): 289–91.
- Byrdwell, W. C. (2005a). *Modern Methods for Lipid Analysis by Liquid Chromatography/Mass Spectrometry and Related Techniques*. Champaign, American Oil Chemists’ Society.
- Byrdwell, W. C. (2005b). Atmospheric Pressure Ionization Techniques in Modern Lipid Analysis. *Modern Methods for Lipid Analysis*. W. C. Byrdwell. Champaign, IL, American Oil Chemists Society: 1–18.
- Byrdwell, W. C. (2005c). Dual Parallel Liquid Chromatography/Mass Spectrometry for Lipid Analysis. *Modern Methods for Lipid Analysis*. W. C. Byrdwell. Champaign, IL, American Oil Chemists Society: 510–76.

- Cai, S.-S. and Syage, I. (2006). *J. Chromatogr. A* 110: 15–26.
- Christie, W. W. (1992). Detectors for High Performance Liquid Chromatography of Lipids with Special Reference to Evaporative Light Scattering Detection. *Advances in Lipid Methodology*. W. W. Christie. Ayr, Scotland, The Oily Press. One: 269–72.
- Christie, W. W. (1996). Separation of Phospholipid Classes by High Performance Liquid Chromatography. *Advances in Lipid Methodology*. W. W. Christie. Ayr, Scotland, The Oily Press. Three: 77–108.
- Codex, F. C. (2004). *Food Chemicals Codex: Effective January 1, 2004*, Washington, National Academies Press.
- Dang, H. V. et al. (2006). *J. Pharm. Biomed. Anal.* 40(5): 155–65.
- Daniels, D. H. (1982). *J. Assoc. Off. Anal. Chem.* 65(1): 162–5.
- Daniels, D. H. et al., (1985). *J. Agric. Food Chem.* 33(3): 368–72.
- DeMeulenaer, B. et al. (2000). *H. Chromatogr.* 896(1–2): 239–51.
- Dieffenbacher, A. et al. (1988). *Rev. Fr. Corps Gras* 35(12): 495–9.
- Dieffenbacher, A. et al. (1989). *Rev. Fr. Corps Gras* 36(2): 64.
- Diepenmaat-Walters, M. G. E. et al. (1997). *J. Am. Soc. Brew. Chem.* 55(4): 147–52.
- Duden, R. and Fricker, A. (1977). *Fette Seifen Anstrichm.* 79(12): 489–91.
- El-Sebaï, L. A. et al. (1980). *Food Chem.* 5(3): 217–28.
- Erdahl, W. L. et al. (1973). *J. Am. Oil Chem. Soc.* 50(12): 513–5.
- Everts, S. and Davis, J. H. (2000). *Biophys. J.* 79(2): 885–7.
- Filip, V. and Kleunova, M. (1993). *Z. Lebensm. Unters. Forsch* 196(6): 532–35.
- Firestone, D. (2001). *Physical and Chemical Characteristics of Oils, Fats, and Waxes*. Champaign, IL, The American Oil Chemists Society.
- Firestone, D., Ed. (2005a). *Official Methods and Recommended Practices of the AOCS*. Champaign, IL, The American Oil Chemists Society.
- Firestone, D., Ed. (2005b). AOCS Recommended Practice Cd-11c-93: Quantitative Separation of Monoglycerides, Diglycerides, and Triglycerides by Silica Gel Column Chromatography.
- Firestone, D., Ed. (2005c). AOCS Recommended Practice Ja 7–86: Phospholipids in Lecithin Concentrates by Thin Layer Chromatography.
- Firestone, D., Ed. (2005d). AOCS Official Method Cd 11–57: alpha-Monoglycerides.
- Firestone, D., Ed. (2005e). AOCS Official Method Ca 14–56: Total Free and Combined Glycerol: -Iodimetric -Periodic Acid Method.
- Firestone, D., Ed. (2005f). AOCS Official Method Cd 3d-63: Acid Value.
- Firestone, D., Ed. (2005g). AOCS Official Method Ca 5a-40: Free Fatty Acids.
- Firestone, D., Ed. (2005h). AOCS Official Method Tg 1–64: Iodine Value—Wijs <method & AOCS Recommended Practice Ja 14–91: Iodine Value—Wijs Method (for lecithin).
- Firestone, D., Ed. (2005i). AOCS Recommended Practice Cd 1b-87: Iodine Value of Fats and Oils—Cyclohexane Method.
- Firestone, D., Ed. (2005j). AOCS Official Method Cd 8–53: Peroxide Value - Acetic Acid-Chloroform Method & AOCS Official Method Ja 8–87: Peroxide Value (for lecithin).
- Firestone, D., Ed. (2005k). AOCS Official Method Cd 8b-90: Peroxide Value—Acetic Acid-Isooctane Method.
- Firestone, D., Ed. (2005l). AOCS Recommended Practice Cd 3c-91: Saponification Value — Modified Method Using Methanol & AOCS Official Method Tl 1a-64: Saponification Value.
- Firestone, D., Ed. (2005m). AOCS Official Method Cd 13–60: Hydroxyl Value.
- Firestone, D., Ed. (2005n). AOCS Official Method Cd 5–40: Reichert-Meisel, Polanske, and Kirschner Values—Modified AOAC Methods.
- Firestone, D., Ed. (2005o). AOCS Official Method Ca 2e-84: Moisture—Karl Fischer Reagent.
- Firestone, D., Ed. (2005p). AOCS Official Method Tb 2–64: Moisture - Modified Karl Fischer Reagent.
- Firestone, D., Ed. (2005q). AOCS Official Method Ja 2b-87: Moisture - Karl Fischer Reagent.
- Firestone, D., Ed. (2005r). AOCS Recommended Practice Cc 17–95: Soap in Oil.
- Firestone, D., Ed. (2005s). AOCS Official Method Ca 12–55: Phosphorous, and AOCS Official Method Ca 12a-02L Colorimetric Determination of Phosphorous Content in Fats and Oils.
- Firestone, D., Ed. (2005t). AOCS Official Method Cc 13a-92: Color—Lovibond Method Using Color Glasses Calibrated in Accordance with the Lovibond Tintometer Color Scale.

- Firestone, D., Ed. (2005u). AOCs Official Method Cc 13b-45: Color—Wesson Method Using Colored Glasses Calibrated in Accordance with the AOCs Tintometer Scale.
- Firestone, D., Ed. (2005v). AOCs Official Method Ja 9–87: Gardner Color and AOCs Official Method Jd 1a-64 Color—Gardner 1963 (Gardner Standards).
- Firestone, D., Ed. (2005w). AOCs Official Method Cc 13a-43: Color—FAC Standard Color.
- Firestone, D., Ed. (2005x). AOCs Official Method Td 2a-64: Color—Photometric Index and AOCs Official Method Cc 13c-50: Color—Spectrophotometric Method
- Firestone, D., Ed. (2005y). AOCs Official Method Cc 7–25: Refractive Index and AOCs Official Method Tp 1a-64: Refractive Index.
- Firestone, D., Ed. (2005z). AOCs Official Method Cc 1–25: Melting Point—Capillary Tube Method.
- Firestone, D., Ed. (2005aa). AOCs Official Method Cc 3–25: Slip Melting Point—AOCs Standard Open Tube Melting Point and AOCs Official Method Cc 3b-92: Slip Melting Point—ISO Standard.
- Firestone, D., Ed. (2005ab). AOCs Official Method Cc 18–80: Dropping Point.
- Firestone, D., Ed. (2005ac). AOCs Official Methods Ja 11–87 and Tq 1a-64: Viscosity of Transparent Liquids by Bubble Time Method.
- Firestone, D., Ed. (2005ad). AOCs Recommended Practice Ja 10–87: Brookfield Viscosity.
- Firestone, D., Ed. (2005ae). AOCs Official Method Cc 10a-25: Specific Gravity of Liquid Oils and Fats.
- Firestone, D., Ed. (2005af). AOCs Official Method Cc 10b-25: Specific Gravity of Solid Fats and Waxes.
- Firestone, D., Ed. (2005ag). AOCs Official Method Ce 1–62: Fatty Acid Composition by Gas Chromatography.
- Firestone, D., Ed. (2005ah). AOCs Official Method Cd 11b-91: Determination of Mono- and Diglycerides by Capillary Gas Chromatography.
- Firestone, D., Ed. (2005ai). AOCs Recommended Practice Cd 25–96: Heat Transfer Fluids in Oils—Dowtherm™ by GC.
- Firestone, D., Ed. (2005aj). AOCs Official Method Cd 11d-96: Mono and Diglycerides Determination by HPLC-ELSD and AOCs Official Method Ja 7b-91: Determination of Lecithin Phospholipids by HPLC.
- Firestone, D., Ed. (2005ak). AOCs Official Method Ca 14b-96: Quantification of Free Glycerine in Selected Glycerides and Fatty Acid Methyl Esters by HPLC and Laser Light-Scattering Detection.
- Firestone, D., Ed. (2005al). AOCs Recommended Practice Cd 25a-00: Thermal Heating Fluids in Edible Oils and Oleochemicals—Dowtherm A by HPLC Coupled with Fluorescence Detector.
- Firestone, D., Ed. (2005am). AOCs Official Method Ca 12a-02: Colorimetric Determination of Phosphorus Content in Fats and Oils.
- Firestone, D., Ed. (2005an). AOCs Recommended Practice Cd 1e-01: Determination of Iodine Value by Pre-calibrated FT-NIR with Disposable Vials.
- Firestone, D., Ed. (2005ao). AOCs Official Method Ca 18c-91: Determination of Lead by Direct Graphite Furnace Atomic Absorption Spectrophotometry.
- Firestone, D., Ed. (2005ap). AOCs Official Method Ca 15–75: Analysis for Chromium, Copper, Iron, and Nickel in Vegetable Oils by Atomic Absorption Spectrophotometry.
- Firestone, D., Ed. (2005aq). AOCs Recommended Practice Ca 15b-87: Sodium and Calcium by Atomic Absorption Spectrophotometry and AOCs Recommended Practice Ca 17–01: Determination of Trace Elements (Calcium, Copper, Iron, Magnesium, Nickel, Silicon, Sodium, Lead, and Cadmium) in Oil by Inductively Coupled Plasma Optical Emission Spectroscopy.
- Firestone, D., Ed. (2005ar). AOCs Official Method Cd 16b-93: Solid Fat Content (SFC) by Low-Resolution Nuclear Magnetic Resonance - The Direct Method and AOCs Official Method Cd 16–81: Solid Fat Content (SFC) by Low-Resolution Nuclear Magnetic Resonance - The Indirect Method.
- Flor, E. V. and Prager, M. J. (1980). *J. Assoc. Off. Anal. Chem.* 63(1): 22–6.

- Franzke, C. (1977). *Z. Lebensm. Unters. Forsch.* 163(3): 206–7.
- Franzke, C. and Kroll, J. (1980). *Nahrung* 24(1): 89–90.
- Frison-Norrie, S. S., P. (2001). *J. Agric. Food Chem.* 49(7): 3335–40.
- Gaonkar, A. and McPherson, A., Ed. (2005). *Ingredient Interactions: Effects on Food Quality. Food Science and Technology*. Boca Raton, CRC Press.
- Garti, N. (1981). *J. Liq. Chromatogr.* 4(7): 1173–94.
- Garti, N. and Ascerin, A. (1983). *J. Am. Oil Chem. Soc.* 60(6): 1151–4.
- Gillet, B. et al. (1998). *Analysis* 26(3): M26–M33.
- Glonek, T. and Merchant, R. E. (1996). ^{31}P Nuclear Magnetic Resonance Profiling of Phospholipids. *Advances in Lipid Methodology*. W. W. Christie. Ayr, Scotland, The Oily Press. Three, 37–75.
- Goldstein, S. (1984). U. S. 4,473,651 A.
- Grdadolnik, J. and Hadm, D. (1993). *Chem. Phys. Lipids* 65(2): 121–32.
- Gunstone, F. G. (1993). High Resolution ^{13}C NMR Spectroscopy of Lipids. *Advances in Lipid Methodology*. W. W. Christie. Ayr, Scotland, The Oily Press. Two, 1–68.
- Halverson, H. and Qvist, O. (1974). *J. Am. Oil Chem. Soc.* 51(4): 162–5.
- Ham, X. and Gross, R. W. (2005). Toward Total Cellular Lipidome Analysis by ESI Mass Spectrometry from a Crude Lipid Extract. *Modern Methods for Lipid Analysis*. W. C. Byrdwell. Champaign, IL, American Oil Chemists Society: 488–509.
- Hammond, E. W. (1993). *Chromatography for the Analysis of Lipids*. Boca Raton, FL, CRC Press.
- Hartman, L. et al. (1980). *Analyst* 105(1247): 173–6.
- Hasenhuettl, G. L. et al. (1990). *J. Am. Oil Chem. Soc.* 67(11): 797–9.
- Horvitz, W. Ed. (2005). *Official Methods of Analysis of AOAC International*. AOAC International, Gaithersburg, MD.
- Hsieh, J. Y. et al. (1981). *J. Chromatogr.* 208(2): 398–403.
- Hummel, D. (2000a). *Handbook of Surfactant Analysis*. New York, John Wiley & Sons: 232.
- Hummel, D. (2000b). *Handbook of Surfactant Analysis*. New York, John Wiley & Sons: 233.
- Hurst, W. J. and Martin, R. A. (1984). *J. Am. Oil Chem. Soc.* 61(9): 1462–3.
- Huyghebaert, G. and Baert, L. (1992). *Chromatographia* 34(11–12): 557–62.
- Inger, N. (1986). Determination of Hydroxyl Value by NIR, Personal Communication.
- Istratov, V. et al. (2003). *Tetrahedron* 59(22): 4017–24.
- Jakubaska, E. et al. (1977). *Acta Aliment Pol.* 3(1): 79–84.
- Jodlbauer, H. D. (1976). *Getreide Mehl Brot* 30(7): 181–7.
- Judlbauer, H. D. (1981). *Veroeff. Arbeitsgem. Getreideforsch* 183: 42–9.
- Kaitaranta, J. K. and Bessman, S. P. (1981) *Anal. Chem* 53(8): 1232–1235
- Kanematsu, H. et al. (1972). *Eiyo Shokuryo* 25(1): 46–50.
- Karrer, R. and Herbergt, H. (1992). *J. High Res. Chromatog.* 15(9): 585–9.
- Kato, H. et al. (1989). *J. Assoc. Offic. Anal. Chem.* 72(1): 27–9.
- Kimura, S. et al. (1969). *Nippon Shokuhin Kogyo Gakkai-shi* 16(9): 425–9.
- Kostelnik, R. J. and Castellano, S. M. (1973). *J. Magn. Reson.* 9(2): 291–5.
- Kumar, T. N. et al. (1984). *J. Chromatog.* A 298: 360–5.
- Larsen, A. and Hyattumff, E. (2005). Analysis of Phospholipids by Liquid Chromatography Coupled with On-line Electrospray Ionization Mass Spectrometry and Tandem Mass Spectrometry. *Modern Methods for Lipid Analysis*. W. C. Byrdwell. Champaign, IL, American Oil Chemists Society, 19–60.
- Lee, T. (1988). *J. Assoc. Off. Anal. Chem.* 71(4): 785–8.
- Lee, T. et al. (1993). *J. Am. Oil Chem. Soc.* 70(4): 343–7.
- Lendrath, G. (1990). *J. Chromatogr.* 502(2): 385–92.
- Lew, H. (1975). *Veroff. Landwirtsch. Chem. Bundesversuchsanst. Linz* 97(10): 10.
- Li, Y.-K. et al. (2002). *Sepu* 20(5): 476–478.
- Lindblom, G. (1996). Nuclear Magnetic Spectroscopy and Lipid Phase Behavior and Lipid Diffusion. *Advances in Lipid Methodology*. W. W. Christie. Ayr, Scotland, The Oily Press. Three, 132–99.
- Lundquist, G. and Meloan, C. (1971). *Anal. Chem.* 43(8): 1122–3.

- Luquain, C. et al. (2001). *Anal. Biochem.* 296(1): 41–48.
- Macka, M. et al. (1994). *J. Chromatogr.* 675(1–2): 267–70.
- Martin, E. et al. (1989). *Mitt. Geb. Lebensmittelunters Hyg.* 79(4): 406–12.
- Mazur, A. W. et al. (1991). *Chem. Phys. Lipids* 60(2): 189–99.
- Melton, S. L. (1992). *J. Am. Oil Chem. Soc.* 69(8): 784–8.
- Moelering, H. and Bergmeyer, H. U. (1974). *Methoden Enzym. Anal.* 3. *Neubearbeitete Erweite: Te Aufl.* H. Bergmeyer. New York, Academic. 2: 1860–4.
- Mueller, H. (1977). *Fette Seifen Anstrichm.* 79(6): 259–61.
- Murakami, C. et al. (1989). *Shokuhin Eiseigaku Zasshi* 30(4): 306–13.
- Murgia, S. et al. (2003). *Lipids* 38(5): 585–91.
- Murohy, J. and Grislett, L. (1969). *J. Am. Oil Chem. Soc.* 46(7): 384.
- Murphy, J. M. and Hibbert, H. R. (1969). *J. Food Technol.* 4(3): 227–34.
- Murphy, J. M. and Scott, C. C. (1969). *Analyst* 94(1119): 481–3.
- Nakanishi, H. and Tsuda, T. (1983). *Shokuhin Eisergaku Zasshi* 24(5): 474–9.
- Nunez, A. et al. (2005). *Liquid Chromatography/Mass Sprvtrometry Analysis of Biosurfactant Glycolipids. Modern Methods for Lipid Analysis.* W. C. Byrdwell. Champaign, IL, American Oil Chemists Society: 447–71.
- Olsson, U. et al. (1990). *J. Planar. Chromatogr.–Mod. TLC* 3: 55–60.
- Otles, S. (2004). *Methods of Analysis of Food Components and Additives.* Boca Raton, FL, CRC Press.
- Paganuzzi, V. (1987). *Riv. Ital. Sostanze Grasse* 61(10): 411–14.
- Paquot, C. and Hauffen, A. (Eds.) (1987). *IUPAC Standard Methods of Analysis of Oils, Fats, and Derivatives.* London, Blackwell.
- Pohle, W. et al. (1997). *J. Mol. Struct.* 408–409: 273–7.
- Press, K. et al. (1981). *J. Agric. Food Chem.* 29(5): 1096–8.
- Ranger, B. and Wenz, K. (1989). *J. Planar. Chromatogr. – Mod. TLC* 2(1): 24–7.
- Regula, E. (1975). *J. Chromatogr.* 115(2): 639–44.
- Rhee, J. S. and Shin, M. G. (1982). *J. Am. Oil Chem. Soc.* 59(2): 98–9.
- Rilsom, T. and Hoffmayer, L. (1978). *J. Am. Oil Chem. Soc.* 55(9): 649–52.
- Sacchi, P. et al. (1990). *Revista Italiano delle Sostanze Grasse* 67(5): 245–52.
- Saito, K. et al. (1987). *Shokuhin Eisaigaku Zasshi* 28(5): 372–7.
- Schmidt, M. J. and Ottender, H. (1976). *Getreide Mehl Brot* 30(3): 62–4.
- Schuetze, T. (1977). *Nahrung* 21(5): 405–15.
- Schuyf, P. J. W. and van Platerink, C. J. (1994). *Analysis of Sucrose Polyesters with Electrospray Mass Spectrometry.* 42nd ASMS Conference on Mass Spectrometry, Chicago, IL.
- Senelt, S. et al. (1986). *Turk Hij. Deney. Biyol. Derg.* 43(1): 23–35.
- Sheley, D. M. et al. (1986). *Spectroscopy* 1(2): 38–9.
- Shmidt, A. A. et al. (1976). *Khimicheskava Promyshlennost* 8: 598–600.
- Shmidt, A. A. et al. (1979). *Lebensmittelindustrie* 26(4): 172–173.
- Sotirhos, N. et al. (1986). *Dev. Food Sci.* 12: 601–8.
- Tajano, S. and Kondoh, Y. (1987). *J. Am. Oil Chem. Soc.* 64(7): 1001–3.
- Takagi, T. and Itabashi, Y. (1986). *Yukagaku* 35(9): 747–50.
- Takagi, T. and Ando, Y. (1994). *J. Am. Oil Chem. Soc.* 71(4): 459–60.
- Tanaka, M. et al. (1979). *Yukagaku* 28(2): 96–9.
- Tonogau, Y. et al. (1987). *Shokuhin Eisaigaku Zasshi* 28(6): 427–35.
- Trautler, H. and Nikiforov, A. (1984). *Anal. Chem. Symp. Ser.* 21: 299–304.
- Tsuda, T. et al. (1984). *J. Assoc. Off. Anal. Chem.* 67(6): 1149–51.
- Tumanaka, K. and Fujita, N. (1990). *Yukagaku* 19(6): 393–7.
- Uematsu, Y. et al. (2001). *J. AOAC Int.* 84(2): 498–506.
- Vyncke, W. and Lagrou, F. (1973). *Meded. Fac. Landbouwwetensch* 38(3): 235–52.
- Watanabe, M. et al. (1986). *Yakagaku* 35(12): 1018–24.
- Wood, E. et al. (2004). *Analytical Methods for Food Additives.* Boca Raton, CRC Press.
- Wyrziger, J. (1968). *Ber. Getreidechem. Tag Detmold.* 45–57.
- Yamanaka, S. and Kudo, K. (1991). *CA* 115:123048. Japan 03107765
- Yusupoca, I. et al. (1976). *Khim. Prom-St.* 598–600, CA 88:35919.

Chapter 4

Emulsifier-Carbohydrate Interactions

Gerard L. Hasenhuettl

Since emulsifiers are amphiphilic molecules, they interact with other polar and nonpolar ingredients commonly present in food (Gaonkar and McPherson, 2005). Interactions with water, carbohydrates, proteins, fats, oils, and flavors have been studied. Interactions may be beneficial, such as retardation of staling in bread, or adverse, such as distortion of a flavor profile. Several mechanisms may be responsible for producing interactive effects: (1) Competition of emulsifiers and ingredients for the interface, (2) Competition for available water, (3) Solubility of ingredients in emulsifiers, (4) Electrostatic interactions between charged species, (5) Nonpolar interactions, or (6) physical or packing interactions, such as entanglement or crystal packing. Since more than one mechanism may be operational in a given food system, explanation of ingredient interactions are often difficult to obtain with a high degree of certainty.

Carbohydrates are ubiquitous in food products. Nutritionally, they serve as sources for rapidly available energy. They also contribute to sensory properties, such as sweetness and texture. Carbohydrates range from low molecular weight simple saccharides to highly complex structures, such as starches and hydrocolloids (Belitz et al., 2004a). Their interactions with food surfactants are extremely important in many foods, such as bakery products. Recently, the epidemics of obesity and Type II diabetes have stimulated reformulation of foods toward lower sucrose and more carbohydrates having lower glycemic indices (Warsaw and Kukami, 2004). Emulsifier carbohydrate interactions may be different in these new formulations.

This chapter will discuss carbohydrate classes where interactions have been thoroughly studied, but will also point out where not enough is known.

4.1 Interactions with Simple Saccharides

Simple saccharides, such as sucrose, fructose, or lactose occur naturally in foods or are added to obtain some benefit. Sugars contribute sweetness in varying degrees depending on their structural configuration. However, they also function as humectants to retain water but reduce water activity, in order to improve microbial stability. For example, water activity has an effect on cell permeability of *Staphylococcus*

aureus (Vilhelmson and Miller, 2002). Other ingredients such as glycerol, propylene glycol, and sorbitol, also function as humectants.

Because there are no lipophilic groups in simple saccharides, these molecules have little or no interfacial activity. They do have a strong tendency to form hydrogen bonds, possibly with polar regions of surfactants. Lecithin has a long history of use in the confectionery industry to control viscosity and reduce stickiness (see Chap. 10). Inverse gas chromatography (IGC) has shown that lecithin and polyglycerol polyricinoleate (PGPR) modified the surface of sucrose particles to make it more lipophilic (Rouset et al., 2002). Sugar particles, concentrated in oil dispersions, were found to interact with one another (Bahm et al., 2006). Water bridging and minor components also influence these forces (Gaonkar, 1989; Johansson and Bergenstahl, 1992c). Water vapor permeability through confectionery coatings is also strongly affected by composition (Ghosh et al., 2005). Surfactants, such as lecithin, PGPR, and monoolein inhibit these interactions, resulting in decreased viscosity and sedimentation (Johansson and Bergenstahl, 1992a,b; Servais et al., 2004). Sugar particles may also serve as heterogeneous crystallization nuclei for the confectionery fats (Aronbine et al., 1988; Dhonsi and Stapley, 2006). Recent work has also determined differences in the magnitude of interactive forces in butterfat, cocoa butter, and lauric fats (Dickinson et al., 2005).

Saccharides can compete with mesophase-forming surfactants for available water. Functional properties are often modified by this competition.

4.2 Starch/Surfactant Complexes

Perhaps the most widely studied interactions of food surfactants have been with starch. Linear α -helical regions of starch form inclusion (or clathrate) compounds with single-tailed surfactants. Examples are monoacylglycerols and sodium stearoyl lactylate (SSL). The saturated fatty acids bonded to these ingredients are trapped inside the helices, and are held by lipophile-dipole forces.

Starch molecules are of two types. Amylose has a linear chain structure, while amylopectin has a number of branches. The distribution depends on the vegetable source (Mitolo, 2005) and, for wheat starch; properties depend on fractions obtained from the milling process (Tang et al., 2005). For example, Potato starch is high in amylose, while waxy maize is higher in amylopectin. Amylose forms a left-handed helix with 6 glucosyl units per turn and 0.88 nm between helices (Mikus et al., 1946). Branches on the amylopectin interrupt helix formation and reduce the formation of inclusion complexes with surfactants. Monoacylglycerol complexes were shown to form weaker complexes with amylopectin than amylose (Hahn and Hood, 1987; Lagendiik and Pennings, 1970; Twillman and White, 1988).

Complexing agents may include any molecule with a lipophilic component, and a structure with a diameter of 4.5–6 Å. Iodine (as I_3) forms inclusion complexes with starch. This phenomenon allows starch to be used as an indicator in the titrimetric determination of iodine. Saturated alkyl chains of fatty acids, dimethyl sulfoxide, and linear alcohols may complex inside the helix. Some flavor compounds may be

trapped in the α -helix of amylose, resulting in a decreased flavor impact (Rutschmann and Solms, 1990; Maier et al., 1987; Schmidt and Maier, 1987).

In solution by itself, amylose exists as a random coil structure; In the presence of a complexing agent, energy minimization forces the structure into a helix conformation (Neszmelyi et al., 1987). Saturated fatty acid chains are lipophilic and are attracted to the dipole-induced, hydrogen-lined interior of the helix (Krog, 1971). Dipole moments continue to stabilize the complex by effecting a lipophilic solvation in the core. Computer-derived models confirm the stability of the complex based on energy minimization principles (Neszmelyi et al., 1987). Complexing agents compete for available space in the helix and readily undergo reversible interchange (Mikus et al., 1946; Schoch and Williams, 1944). Unit cell packing dimensions and the distance between amylose helices are not affected by the nature of the complexing agent (Raphaelides and Karkalas, 1988). Alkyl lipid chains usually occur as dimers in solution, with the polar head groups held together by hydrogen bonds. For fatty acids, it is the carboxyl group; for monoacylglycerols, glycerol is the polar moiety.

Complexes between amylose and alkyl chains of lipids aggregate into partially crystallized structures. X-ray diffraction shows a V-pattern (Szezodrak and Pomeranz, 1992). These insoluble complexes consist of lamellar mesophases, which are perpendicular to the helices (Raphaelides and Karkalas, 1988). Amylose and Amylopectin complexes with lipids can be differentiated by their physical properties. For example, amylopectin complexes are more soluble in aqueous systems than amylose complexes. Saturated fatty acids have long been used to selectively precipitate amylose from solution (Schoch and Williams, 1944). The relative solubility of amylose and amylopectin complexes can vary with various surfactants (Kim and Robinson, 1979). Iodine may be used to differentiate amylose from amylopectin, since it forms blue complexes with amylose and a red-purple complex with amylopectin.

4.3 Effect of External Lipids on Starch Properties

4.3.1 General

Native fats and oils, used in foods, contain small amounts of surfactants. For example, soybean oil contains low levels of lecithin and mono/diacylglycerols. Surface tension effects have been demonstrated by their removal by adsorption on Florisil (Gaonkar, 1989). These minor constituents may be treated as a constant by product developers, providing the concentrations do not vary significantly from batch to batch. Surfactants that are deliberately added (external lipids) exert a greater effect and may be used to control properties of starches in food formulations. For example, starch/surfactant complexes retard the firming (staling) of bread, prevent stickiness and promote rehydration in instant potato products, and control the texture of extruded foods. Data for high amylose (normal) starches are shown in Table 4.1, while properties for high-amylopectin (waxy) starches are summarized in Table 4.2

Table 4.1 Effect of emulsifiers and complexing agents on properties of nonwaxy starch

Effect of complexation on starch properties	Starch type/Fraction	Complexing agent	Reference(s)
Reduce iodine-binding capacity	Wheat	Sucrose monoesters	Bourne et al. 1960
	Potato	GMS	Conde-Petit and Escher, 1992
	Maize, potato, tapioca, wheat	Sucrose esters	Deffenbaugh, 1990
	Wheat	GMS, SSL	Ghiasi et al., 1982a
	Potato amylose	EMG, polysorbate 60	Kim and Robinson, 1979
	Amylose	MG	Krog, 1971; Krog and Nybo-Jensen, 1970 Krog (1981)
	Tapioca	CTAB, GMS, SLS	Moorthy, 1985
Repress granule swelling and starch solubilization	Amylose	Sucrose esters	Osman et al., 1961
	Wheat	Sucrose monoesters	Bourne et al., 1960
	Maize, potato, wheat	GMS, SSL	Eliasson, 1986b
	Wheat	GMS, SSL	Ghiasi et al., 1982a
	Potato	MG	Hoover and Hadziyev, 1981
	Potato amylose	EMG, polysorbate 60	Kim and Robinson, 1979
	Amylose	MG	Krog, 1971
	Tapioca	MG	Mercier et al., 1980
	Tapioca	CTAB, GMS, SLS	Moorthy, 1985
	Amylose	Sucrose esters	Osman et al., 1961
	Nonwaxy	MG	Strandine et al., 1951
	Wheat flour	MG, SSL	Roach and Hoseney, 1995a,b
	Nonwaxy	MG	VanLonkhuysen and Blankestin, 1974
Increase granule swelling; make gelatinization occur earlier	Maize, potato, wheat	SDS	Eliasson, 1986b
Destabilize granule and increase paste viscosity	Tapioca	SLS	Moorthy, 1985
Decrease starch thickening power <85 °C (before gelatinization)	Wheat	DATEM, MG, SSL	Evans, 1986
	Wheat	GMS, SSL	Ghiasi et al., 1982b
	Potato	MG	Hoover and Hadziyev, 1981
Delay loss of birefringence	Wheat	Sucrose monoesters	Bourne et al., 1960
	Wheat starch	Sucrose monoesters	Ebeler and Walker, 1984

(continued)

Table 4.1 (continued)

Effect of complexation on starch properties	Starch type/Fraction	Complexing agent	Reference(s)
	Wheat	SSL	Eliasson, 1985
	Maize, potato, wheat	GMS, SDS, SSL	Eliasson, 1986b
	Wheat	MG, SSL	Ghiassi et al., 1982a,b
	Wheat flour	Sucrose monoesters	Pomeranz et al., 1969
	Potato	MG	Rilsom et al., 1984
	Various	MG	VanLonkhuysen and Blankestin, 1974
Increase initial pasting temperature, hot paste viscosity, temperature of peak viscosity (i.e. amylograph or RVA) delayed gelatinization	Maize, potato, tapioca, wheat	Sucrose ester	Deffenbaugh, 1990
	Wheat starch	Sucrose monoesters	Ebeler and Walker, 1984
	Wheat	SSL	Eliasson, 1983
	Potato, wheat	SSL	Eliasson, 1986b
	Wheat	DATEM, MG, SSL	Evans, 1986
	Nonwaxy	POEMS	Favor and Johnston, 1947
	Maize	MG	Krog, 1971
	Maize, potato, tapioca, wheat	DATEM, MG, SSL	Krog, 1973
	Pea flour	SSL	
	Wheat flour	Sucrose monoesters	Pomeranz et al., 1969
	Potato	MG	Rilsom et al., 1984
	Masa harina flour	MG	Twillman and White, 1988
Stabilize pasting viscosity and prevent long cohesive texture	Tapioca	GMS, SLS	Moorthy, 1985
Decrease peak viscosity	Waxy maize, potato	POEMS	Favor and Johnston, 1947
Decrease gelatinization enthalpy	Maize, potato, tapioca, wheat	Sucrose ester	Deffenbaugh, 1990
	Potato, wheat	CTAB, saturated. MG, SDS, SSL, lecithin, lysolecithin	Eliasson, 1986a
Increase setback viscosity	Masa harina flour	MG	Twillman and White, 1988
Increase setback viscosity (gelation)	Maize, potato, tapioca, wheat	Sucrose ester	Deffenbaugh, 1990
Depressed G' and G'' ; increased temperature of G' and G'' ; increased viscous part of visco-elastic response	Maize, potato, wheat	GMS, SLS	Eliasson, 1986b

(continued)

Table 4.1 (continued)

Effect of complexation on starch properties	Starch type/Fraction	Complexing agent	Reference(s)
Induced gelation (increased rigidity of fresh starch gels)	Maize, potato, wheat	CSL, GMS	Conde-Petit and Escher, 1994
Decreased gel volume of heated starch	Wheat	MG, SSL	Eliasson, 1985
Decrease cold paste viscosity	Maize, potato, tapioca, wheat	POEMS	Favor and Johnston, 1947
	Maize	MG	Krog, 1971; Osman and Dix, 1960
	Potato	MG	Hoover and Hadziyev, 1981
	Potato	MG	Rilsom et al., 1984
Decrease retrogradation of starch	Amylose/amylopectin mixtures	CTAB, SDS	Gudmondsson and Eliasson 1990; Krog and Nybo-Jensen, 1970; Lagendiik and Pennings, 1970
	Rice	DATEM, MG, SSL, sucrose esters	Miura et al., 1992
Decrease Amylopectin recrystallization	Maize	Sucrose esters	Matsunaga and Kainoma, 1986
Decreased formulation of resistant starch	Barley, maize, waxy maize	EMG, DATEM, MG, SSL	Szezodrak and Pomeranz, 1992
Reduced gel breaking strength	Maize, potato, wheat	CSL, GMS	Conde-Petit and Escher, 1994
Reduced starch extrudate	Tapioca	MG	Mercier et al., 1980
Solubility and retrogradation	Potato and maize	CSL, MG	Staeger et al., 1988
Reduced <i>in vitro</i> enzymolysis	Potato	MG, SSL	Ghiasi et al., 1982a
With β -amylase	Potato amylose	EMG, polysorbate 60	Kim and Robinson, 1979
Reduced <i>in vitro</i> amyloglucosidase digestion	Amylose	MG	Eliasson and Krog, 1985
Reduced <i>in vitro</i> α -amylase digestion	Amylose	MG	Eliasson and Krog, 1985
	Potato amylose	Lysolecithin	Holm et al., 1983
Decreased glucoamylase digestibility	Maize, potato, tapioca, wheat	Sucrose esters	Deffenbaugh, 1990
	Potato amylose	Lysolecithin	Holm et al., 1983
Slowed rate of <i>in vivo</i> α amylase digestion	Potato amylose	Lysolecithin	Holm et al., 1983

CSL calcium stearoyl lactylate, CTAB cetyltrimethylammonium bromide, DATEM diacetyltartaric acid esters of monoglycerides, EMG ethoylated monoglycerides, GMS glycerol monostearate, MG monoglycerides, POEMS polyoxyethylene monostearate, SDS sodium dodecyl sulfate, SLS sodium lauryl sulfate, SSL sodium stearoyl lactylate

Table 4.2 Effect of emulsifiers and complexing agents on properties of waxy starch

Effect of complexation on starch properties	Starch type/fraction	Complexing agent	Reference(s)
Slight reduction in iodine-binding capacity	Amylopectin	MG	Krog, 1971; Krog and Nybo-Jensen, 1970
No reduction in iodine-binding capacity	Waxy maize Potato amylopectin	Sucrose esters Sucrose monostearate	Deffenbaugh, 1990 Bourne et al., 1960
No effect on swelling	Potato amylopectin	Sucrose monostearate	Bourne et al. 1960
Slight delay in peak viscosity	Waxy maize	Sucrose esters	Deffenbaugh, 1990
Viscosity profile not affected	Amylopectin	MG	Hoover and Hadziyev, 1981
Decreased hot paste viscosity	Waxy maize Waxy maize	DATEM, MG, SSL POEMS	Evans, 1986 Favor and Johnston, 1947
Depressed G' and G'' ; slightly increased temperature of G' and G'' ; slightly increased viscous part of viscoelastic response	Waxy barley	GMS, SLS	Eliasson, 1986b
Insoluble complex precipitated	Potato amylopectin	Sucrose monostearate	Bourne et al., 1960
No extrudate complex formed	Amylopectin Waxy maize	MG CSL, MG	Batres and White, 1986 Staeger et al., 1988
No complex detected by x-ray diffraction or DSC	Waxy maize	Sucrose esters	Deffenbaugh, 1990
Weak complex suggested by glucoamylase digestion; viscosity profiles, high-performance size exclusion chromatography and NMR	Waxy maize	Sucrose esters	Deffenbaugh, 1990
Complex confirmed by DSC and x-ray diffraction	Potato amylopectin	CTAB, SDS	Gudmundsson and Eliasson, 1990
Reduced amylopectin retrogradation	Waxy maize Amylopectin Potato amylopectin	CTAB, unsaturated. MG CTAB, SDS	Eliasson 1988 Gudmundsson and Eliasson, 1990

CSL Calcium stearoyl lactylate, *CTAB* cetyltrimethylammonium bromide, *DATEM* diacetyltartaric acid esters of monoglycerides, *EMG* ethoylated monoglycerides, *GMS* glycerol monostearate, *MG* monoglycerides, *POEMS* polyoxyethylene monostearate, *SDS* sodium dodecyl sulfate, *SLS* sodium lauryl sulfate, *SSL* sodium stearoyl lactylate

4.3.2 Iodine Binding Capacity

Surfactants, containing fatty acids, reduce the iodine binding capacity (IBC) of nonwaxy starches. This effect is due to the reversible exchange of the alkyl chain and I_3 inside the amylose helix. Little or no reduction of IBC has been observed for waxy, high-amylopectin starches (Table 4.2). The average length of amylopectin branches is 20–26 glucose residues. Fatty acids require 3 turns of a straight helix with 6 residues/turn in order to form complexes. Although significant modification of the properties of waxy starches may be achieved using surfactants, IBC values are low and differences are difficult to detect. (Fig. 4.1) Iodine binding is therefore, not a sufficiently sensitive method for evaluating high-amylopectin starches.

4.3.3 Starch Pasting

Starches and starch-containing ingredients are largely responsible for the texture of many food products. In fat-reduced or fat-free products, starch networks are often used to immobilize free water and prevent syneresis. They may also interact with flavor and aroma molecules (Lopes de Silva et al., 2002; Preininger 2005; Ferry et al., 2006). When starches are heated in the presence of water, the starch granules absorb water and swell. During cooking, the linear amylose starch leaches from the granule. The resulting composition is a mixture of swollen granules, granule fragments, and colloidal starch particles (Olkku and Rha, 1978). The paste viscosity increases dramatically to a peak value during cooking. However, the swollen starch granules are very fragile and will begin to disintegrate. Applied shear forces, mixing for example, will accelerate this disintegration. As this process proceeds,

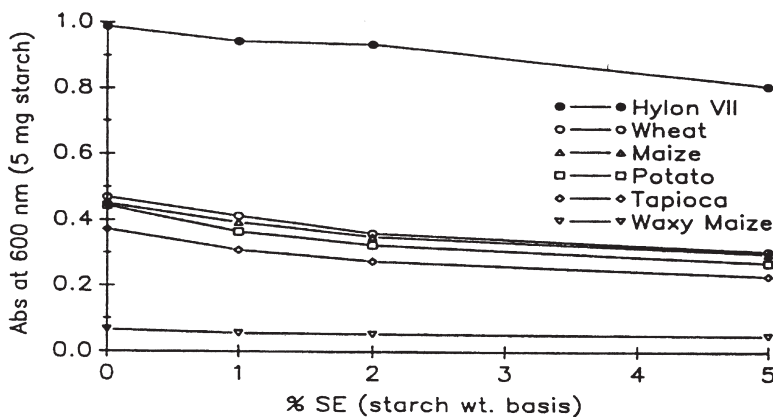

Fig. 4.1 Iodine-binding capacity of starches measured in the presence of a sucrose ester emulsifiers. (From Deffenbaugh, 1990.)

viscosity will rapidly decrease. Added surfactants tend to stabilize the swollen starch granule. Sodium stearoyl lactylate increases cold paste viscosity of wheat, corn, and potato starches (Azizi and Rau, 2005). Addition of shortening increases paste viscosity for wheat and corn starches, but decreases it for potato starch.

4.3.4 Starch Gelatinization

Gelatinization is a process in which crystalline structure is lost during cooking. The process is a first-order, water-mediated melting of the crystalline regions in the starch granule (Donovan, 1979; Zobel, 1984). Maximum swelling and solubilization occur in the presence of excess water (>5 times). Typical formulations meeting this condition are puddings, sauces, and gravies. Incomplete starch hydration occurs in lower-moisture products, such as baked or extruded products. Extremely high viscosities can be achieved in low-moisture systems.

Useful applications in foods have been greatly expanded by using starch/surfactant interactions. Surfactant effects on processing variables can produce cooked starches, or cereal grain products, with significantly modified properties (Lund, 1984). Order of ingredient addition is a critical variable. For example, if monoacylglycerols are added before starch gelatinization occurs, the surfactants penetrate the starch granule and form complexes. This results in a decrease in granule swelling power. Addition of monoacylglycerols after starch gelatinization stabilizes the starch granule against rupture and additional amylose solubilization (Van Lonkhuysen and Blankestijn, 1974). Surfactants, added prior to gelatinization (e.g., polysorbate 60), adsorb to the surface of the starch granule (Kim and Walker, 1992). The surface is rendered lipophilic, which retards the migration of water into the granule.

The effects of surfactants on starch gelatinization can be measured in a number of ways (see Table 4.1). When starch pastes were prepared with glycerol monostearate (GMS) or sodium stearoyl lactylate (SSL), changes in viscoelastic properties coincide with reduced swelling of the granules (Eliasson, 1986b). The granules were less deformable, as indicated by the higher temperatures required to reach peak values for storage modulus (G') and loss modulus (G''). Pasting temperature, hot viscosity, and temperature to peak viscosity for normal starches were increased by surfactants capable of forming inclusion complexes. Obviously, if a starch is added to a food formulation, effects were thought to arise from the improved ability of the starch granule to hold water without rupturing (Mitchell and Zalman, 1951).

Starch, in its native form, displays birefringence when viewed with a polarized light microscope. Gelatinization and melting of the crystalline regions in the starch granule, lead to loss of birefringence and disappearance of the characteristic x-ray diffraction pattern (Eliasson, 1986a). Starch-complexing surfactants slow the rate of gelatinization and, as a result, retard the loss of birefringence.

Some surfactants do not form complexes with starch. Sodium dodecyl sulfate (SDS) has a strong destabilizing effect on starch granule, possibly because of its strong negative charge, detergent power or high potential to form micelles (Eliasson,

1986b; Moorthy, 1985). Destabilization is manifested by a rapid swelling and viscosity increase, followed by granule disruption and viscosity decrease. SDS is a salt of a strong acid and a strong base. Sodium stearyl lactylate is an ionic surfactant, the salt of a weak acid and a strong base, which forms complexes and stabilizes starch granules. Obviously, when starch is added to a food formulation in order to build viscosity, surfactants, which stabilize the integrity of swollen starch granules, should be selected. In a starch gel, formed from a paste, swollen starch granules are imbedded in, and stabilize an amylose matrix (Ring, 1985). As a starch paste cools, molecules become less soluble and aggregate (Osman, 1967). Cross-linking of the network increases the consistency and the resistance to an applied external force (Zobel, 1984). Some recent work indicates little difference between complexing and noncomplexing surfactants on the gel network structure (Richardson et al., 2004). Gelation is caused by rapid precipitation of amylose while amylopectin tends to crystallize more slowly. Amylopectin requires relatively higher concentrations to undergo precipitation. Amylose forms gels by entrapping water molecules, swollen starch granules, and granule fragments in the helical network. In starch pastes prepared with surfactants, the insoluble complex forms the gel (Conde-Petit and Escher, 1992). Amylose/surfactant complexes accelerate gelation in the first few hours of storage, compared to starch gels made without surfactant (Conde-Petit and Escher, 1994). Gelation of maize, potato, tapioca, and wheat starch is responsible for setback viscosity profiles, as shown in Fig. 4.2 (Deffenbaugh, 1990). Sucrose esters increased setback viscosity by forming complexes that accelerated gelation. Surfactants may be used to induce and control gelation in starch-containing foods (Conde-Petit and Escher, 1992).

4.3.5 Starch Retrogradation

Retrogradation is the formation of ordered, partially crystalline regions in a cooled starch paste. It is a slow process that occurs hours to weeks after pasting and gelation. In high-amylose containing foods, the process may be complete before the product is distributed and consumed. Retrogradation may cause significant deterioration of texture and flavor attributes during shelf life (Miles et al., 1985). Starch-complexing surfactants retard retrogradation of starch, and this is a major application for surfactants in the processed food industry. This effect is due to prevention of side-by-side stacking of starch helices (Miura et al., 1992). Nucleation sites for retrogradation or recrystallization are thereby reduced (Matsunaga and Kainoma, 1986).

Amylopectin retrogradation plays an important role in shelf life stability in some foods. The increase in firmness and loss of flavor in staled bread are caused by retrogradation of the amylopectin fraction of wheat starch (Schoch and French, 1947; Gudmondson and Eliasson, 1990). Control or modification of amylopectin retrogradation by incorporation of surfactants has practical significance.

Interactions between surfactants and amylopectin are more difficult to demonstrate than interactions between surfactants and amylose. Nevertheless, a number of

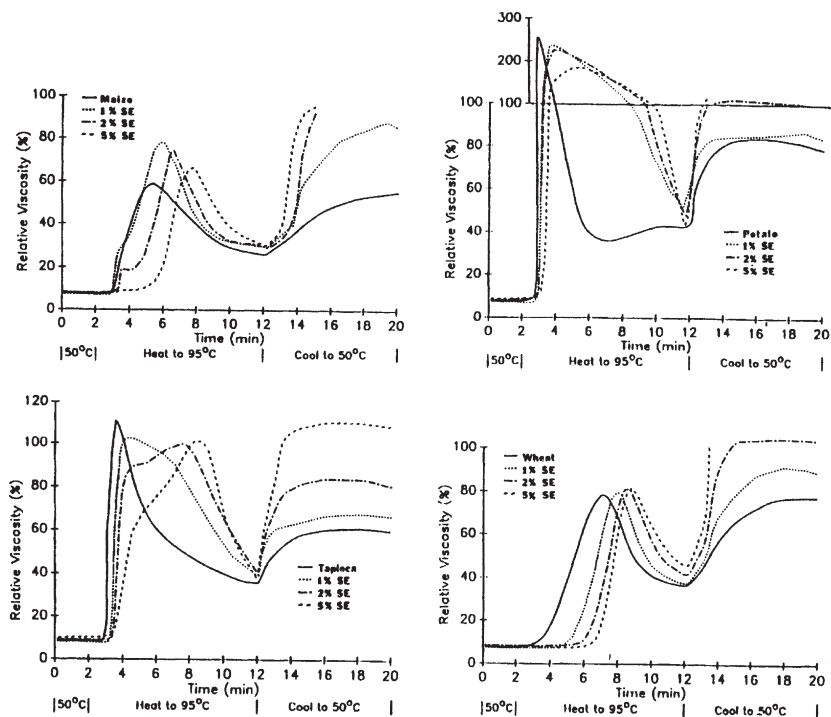

Fig. 4.2 Rapid Visco Analyzer viscosity profiles of maize, potato, tapioca, and wheat starches with 0, 1, 2, or 5% (starch wt basis) of sucrose ester emulsifier. (From Deffenbaugh, 1990.)

reports of indirect evidence in the literature are noted (Evans, 1986; Eliasson and Ljunger, 1988). For example, insoluble complexes between monoacylglycerols and amylopectin have been observed (Batres and White, 1986). Amylase digestion of waxy maize starch was slightly reduced by the presence of surfactant. A delay in viscosity increase during gelatinization also suggests that surfactants interact with amylopectin. Differential scanning calorimetry and x-ray diffraction detected the interaction of monoacylglycerols and other surfactants (Gudmondsson and Eliasson, 1990). These results were correlated with a reduction of amylopectin retrogradation. When amylose and amylopectin are present together, surfactants will preferentially complex with the amylose. As a result, the amylose cannot co-crystallize with the amylopectin and the effect of surfactant on amylopectin is indirect.

4.3.6 Enzymolysis of Starch

Glucoamylase is an enzyme, which cleaves successive glucose units, starting at the nonreducing end of a starch chain. Complex formation with surfactants generally

reduces the rate of enzymolysis (see Table 4.1). This effect may be due to steric hindrance, since the surfactants occupy positions between starch helices. For high-amylose starches, the helical chain may be rendered unavailable by precipitation of the complex. Recent studies indicate that *in vitro* enzymolysis is significantly affected by crystal morphology, resulting from the extent of gelatinization and retrogradation (Slaughter et al., 2001; Chang et al., 2006). Efforts were made to correlate enzyme kinetics with glycemic indices of some starchy foods. However, it has been reported that sucrose esters do not have an appreciable effect on hydrolysis of amylose or amylopectin (Deffenbaugh, 1990). *In vivo* studies in rats indicated that surfactant/starch complexes did not have a significant effect on the overall digestibility of starch (Holm et al., 1983; Fardet, A., et al.).

4.4 Lipid Adjunct and Surfactant Properties

Since not all surfactants are capable of forming complexes with starch, molecular structure is a critical factor. Single-tailed surfactants with saturated alkyl chains are well suited for complexation. Binding increases as the alkyl chain length increases (Gray and Schoch, 1962; Hahm and Hood, 1987). Other factors, such as the nature of the polar group and the molecular weight govern the degree of penetration of the alkyl chain into the helix (Miura et al., 1992). In addition to the preceding factors, if the geometry of the starch helix is known, the ratio of lipid/starch required to produce saturation of the helix may be determined by stoichiometry (Karkalas and Raphaelides, 1986).

Solubility of the lipid or surfactant determines the equilibrium concentrations of the complex and the lipid in solution. The more soluble the lipid complexing agent, the greater proportion will be present in the aqueous phase. For example, fatty acids are less soluble than monoacylglycerols. Therefore, a greater proportion of the alkyl chain is forced into the lipophilic core of the starch helix. Differential solubility at higher processing temperatures and storage temperatures should also be considered.

Increased unsaturation in the fatty acid chain reduces the ability of the lipid to form inclusion complexes with starch helices (Lagendiik and Pennings, 1970; Krog, 1971; Hahm and Hood, 1987). The 30° angle of the 9,10 *cis*(Z) double bond in the fatty acid chain reduces rotational flexibility and produces steric hindrance to insertion into the helix. Similarly, bulky polar groups pose a steric barrier to complex formation (Gray and Schoch, 1962; Krog, 1971; Hahm and Hood, 1987).

4.4.1 *Starch Granules*

Starch granules may introduce an additional steric barrier to formation of lipid/surfactant complexes. For example, monoacylglycerols exist as micelles or mesophases in an aqueous environment. At low temperatures (<50 °C), these surfactants attach to the surface of the starch granule by simple adsorption (Van Lonkhuisen

and Blankestijn, 1974). As the temperature is increased to $>80^{\circ}\text{C}$, the starch granules swell, and the alkyl chains of the monoacylglycerol penetrate the starch helix. However, some workers have measured strong surfactant/starch complexes at temperatures as low as 60°C , where only slight swelling and gelation were observed (Ghiasi et al., 1982a,b).

4.4.2 *Starch Type and Source*

Starch is a high molecular weight biopolymer with a molecular structure that varies according to its biological source. As previously discussed, the major variation is the relative proportion of amylose and amylopectin. Structural differences affect the properties of surfactant/starch complexes. For example, glycerol monostearate (GMS) restricted swelling of potato starch granules to a greater extent than it did for maize or wheat starch granules (Eliasson, 1986b).

Some traditional methods of analysis, such as iodine binding capacity and glucoamylase digestion, are not sufficiently sensitive to measure the subtle differences due to differences in starch type. Other methods, such as measurement of viscoelastic properties (Eliasson, 1986b) and viscosity (Deffenbaugh, 1990) are capable of distinguishing different starch types in the presence of surfactant. Viscosity parameters for various starches in the presence of sucrose ester surfactants are shown in Table 4.3 (Deffenbaugh and Walker, 1990). The time to peak viscosity changed more for tapioca than for maize, wheat, and potato starches. The surfactant affected setback viscosity most in wheat starch. Potato and tapioca granules were stabilized by complex formation so that swelling and disintegration were more gradual. Starch-complexing surfactants also stabilize the pasting viscosity of tapioca starch (Moorthy, 1985). Viscosity profiles are convenient for studying complex properties in food systems.

4.4.3 *Environmental Conditions*

Temperature affects the stability of starch/surfactant complexes and consequently affects, their functionality in food systems. Iodine and fatty acid binding capacities of amylose decrease with increasing temperature (Banks and Greenwood, 1975; Hahm and Hood, 1987). The starch helix becomes more disorganized and its ability to include complexing agents. Increasing temperature may also increase the solubility and mobility of complexing agents in the aqueous phase.

Binding of some fatty acids by amylose is affected by pH via protonation and deprotonation of the carboxyl group (Hahm and Hood, 1987). Palmitic (C-16) and stearic (C-18) acids form dimers below their pK_a values (4.7–5.0) by hydrogen bonding between their protonated carboxyl groups. Twinning of their alkyl chains makes them too bulky to fit into the amylose helix. Above their pK_a , the carboxyl groups are deprotonated, and the dimer dissociates due to electrostatic repulsion.

Table 4.3 Rheological properties of starches with sucrose esters (Deffenbaugh 1990)

Time to Peak (min)				
Starch	0% SE	1% SE	2% SE	5% SE
Maize	5.43 ¹	5.96 ²	6.72 ³	7.72 ⁴
Potato	3.03 ¹	3.64 ²	4.08 ³	5.15 ⁴
Tapioca	3.67 ¹	4.26 ²	7.23 ³	8.33 ⁴
Wheat	7.32 ¹	8.08 ²	8.45 ³	8.84 ⁴
Waxy maize	3.45 ¹	3.54 ¹	3.86 ²	4.16 ³
Peak viscosity (%)				
Starch	0%SE	1%SE	2%SE	5%SE
Maize	57.9 ¹	77.2 ²	74.3 ²	65.9 ³
Potato	256 ¹	232 ²	226 ³	183.6 ⁴
Tapioca	113.2 ¹	104.9 ²	99.6 ³	101.32 ^{2,3}
Wheat	78.4 ¹	80.1 ¹	81.2 ¹	81.6 ¹
Waxy maize	88.8 ¹	101.6 ²	98.0 ²	89.8 ³
Maximum setback viscosity (%)				
Starch	0%SE	1%SE	2%SE	5%SE
Maize	55.0 ¹	86.0 ²	98.8 ³	97.4 ³
Potato	83.9 ¹	83.9 ¹	110.3 ²	–
Tapioca	61.5 ¹	68.1 ²	84.8 ³	118.0 ⁴
Wheat	78.81 ¹	90.9 ²	129.1 ³	166.6 ⁴
Waxy maize	50.2 ¹	51.0 ¹	52.6 ¹	51.3 ¹

Superscripts 1, 2, 3, 4 indicate significant difference ($p < 0.05$) within starch type

The pH does not affect the binding of lower fatty acids, such as myristic (C-14) or lauric (C-12) that do not form dimmers. Nonionic surfactants, such as monoacylglycerols, are not affected because the carboxyl group is bonded in an ester linkage and is unavailable for protonation and deprotonation.

The amylose-complexing ability of surfactants containing alkyl chains is affected by their phase behavior (Larsson, 1980). The most effective complexing surfactants have a high degree of freedom in the aqueous phase and exhibit lyotropic mesomorphism. Micelles and vesicles (liposomes) are the mesophases that are the best sources of surfactant monomers for complex formation. Other mesophases (lamellar, hexagonal, cubic) are less effective (Rilsom et al., 1984; Eliasson, 1986a); Lysolecithin, a native single-tail lipid in wheat starch forms a complex with amylose which affects functionality in baking. (Krog and Nybo-Jensen, 1970). Addition of exogenous lysophosphatidylcholine dramatically raised the gelatinization temperature of granular maize starch (Toro-Vazquez et al., 2003).

4.5 Physical Properties of Starch/Surfactant Complexes

Physical properties of starch/surfactant complexes have provided valuable insights into the functionality of surfactants in starch-containing food systems. Techniques, such as x-ray diffraction, differential scanning calorimetry, nuclear magnetic resonance, and electron spin resonance, rheology and microscopy have proven especially useful.

4.5.1 X-Ray Diffraction Patterns

X-ray diffraction was one of the first techniques used to identify starch inclusion complexes (Mikus et al., 1946). This technique yields valuable information about the crystallinity of starch. Clathrates (inclusion complexes) are detected when a powder diffractogram displays a “V-pattern.” X-ray diffraction has been widely used to detect an inclusion complex when starch has been heated in the presence of a native lipid or a surfactant (Hanna and Leliievre, 1975; Hoover and Hadziyev, 1981; Eliasson and Krog, 1985; Biliaderis and Galloway 1986; Eliasson 1988; Deffenbaugh 1990; Rutschmann and Solms, 1990). The helical structure of amylose within the complex was also characterized. X-ray diffraction also displayed V-type patterns for complexes formed between amylopectin and surfactants (Gudmondsson and Eliasson, 1990). Studies also indicated that “free” formed inclusion complexes, while amylopectin in waxy maize starch did not (Evans, 1986; Eliasson, 1988).

X-ray diffraction measurements indicate that the unit cell of the starch helix is essentially the same for all complexes with single-tail surfactants. Surfactants with two or more fatty acid side chains are sterically excluded from penetrating the helix and forming complexes (Osman et al., 1961). Most V-complexes have a pitch of approximately 0.8 nm, indicating that the starch chains are folded so that the alkyl chains are perpendicular to the surface of the lamellae.

4.5.2 Infrared Spectroscopy

Infrared spectroscopy is a useful technique to probe the structure of a surfactant inside the amylose helix. Frequencies for the carboxyl (Osman et al., 1961; Batres and White, 1986), Methyl (Batres and White, 1986), and carbonyl (Hahnel et al., 1995) groups have been investigated. The carbonyl group in glycerol monostearate displays a positive shift inside the complex. This is thought to occur because of electron delocalization inside the helix.

4.5.3 Electron Spin Resonance

Stable free radical fatty acid spin probes may be measured using electron spin resonance (ESR). The line shapes in the spectrum are indicative of the environment surrounding the probe. Reduction in the mobility of the spin probe, due to adsorption or inclusion in a viscous medium, is indicated by line broadening. The technique has been used to study the interactions between fatty acids and starch. The motion of the probe was greatly slowed in the presence of wheat, high amylose maize and waxy maize starches (Pearce et al., 1985). Binding was weaker in waxy maize than in other starches. Results were similar at room temperature, and heating

to 90°C and cooling back to room temperature. Binding was thought to occur throughout the granule, since surface adsorption would not account for the amount of probe utilized. The presence of water facilitated binding, presumably by allowing greater penetration into the interior of the granule (Pearce et al., 1985; Nolan et al., 1986). Similar results were found for probes binding to maize and waxy maize starches at room temperature (Johnson et al., 1990). Heating and subsequent cooling were found to destabilize the complex. Heating increases overall spin probe binding by increasing the surface area of the granule and the permeability of the starch granule.

4.5.4 Nuclear Magnetic Resonance

Nuclear Magnetic resonance (NMR) measures chemical shifts for odd-numbered atoms or their isomers (^1H , ^{13}C , ^{17}O , ^{31}P). The chemical environment near the nuclei influences the position and shape of the peak in the spectrum. For example, stereochemistry in a molecule may be determined with the Nuclear Overhauser Effect (NOE). ^{13}C NMR can detect changes in the carbon atoms in starch induced by complex formation with surfactants (Jane et al., 1985; Deffenbaugh, 1990).

Downfield shifts were observed for all carbon atoms of starch, which had been converted into an inclusion complex (Jane et al., 1985). However, C-1 and C-4 were the most pronounced, suggesting a rotation of the C-O bond in the glycosidic linkage. ^{13}C NMR of maize starch in solution displayed a downfield shift of C-1 and C-4 at 55–75 °C in the presence of a complexing agent (Deffenbaugh, 1990). At temperatures above 70 °C, no effect was observed. Although the complex was formed during gelatinization, it could not be detected in solution. Waxy maize starch/surfactant complexes could be detected by ^{13}C NMR.

Proton (^1H) NMR has also been utilized to study complex formation. The signal intensity of the amylose protons was reduced when sodium palmitate was added. This was interpreted as loss of conformational mobility in the helix due to complex formation, which resulted in extreme line broadening (Bulpin et al., 1982). Signal intensity was restored when the system was heated to >90 °C, apparently due to dissociation of the thermally reversible complex. In a study of cycloheptaamylose, signals for H-3 and H-5 were shifted upfield in the presence of lysolecithin (Kim and Hill, 1985). Since these protons were directed toward the interior of the helix, they experienced a more hydrophobic environment after complex formation with the lipid. No band shifts were observed for complexes between amylopectin and monoacylglycerols (Batres and White, 1986).

Decoupled ^{17}O NMR was used to study the stability of taro pastes toward retrogradation during storage (Lai, 1998). Shifts in signals indicated that water, sugar, and starch mobility were reduced in the presence of monoacylglycerols and sodium stearoyl lactylate.

4.5.5 Differential Scanning Calorimetry

When a sample is heated or cooked while accurately measuring temperature, thermal transitions and enthalpy are detectable by differential scanning calorimetry (DSC). Gelatinization of starch is a water-mediated endothermic melting transition. Starch/surfactant complexation displays crystallization during heating (Eliasson, 1983; Biliaderis and Galloway, 1986; Evans, 1986; Eliasson, 1986a; Eliasson, 1988; Deffenbaugh, 1990). Data in Table 4.4 show the effect of sucrose esters on gelatinization temperatures and enthalpies of various starches (Deffenbaugh, 1990). Data indicates a delay in gelatinization, consistent with observations made using other methods. However, at transition temperatures of 100–115°C and high moisture levels, melting and crystallization transitions may merge into a single peak.

The gelatinization endotherm is not observed in DSC sample re-scans because the gelatinization process is irreversible. In contrast, starch/lipid complexes melt and recrystallize reversibly. Multiple DSC scans are therefore very useful to confirm the existence of starch/lipid complexes (Hoover and Hadziyev, 1981; Kugimiva and Donovan, 1981; Eliasson, 1988; Staeger et al., 1988; Deffenbaugh, 1990; Szezodrak and Pomeranz, 1992).

Table 4.4 DSC Parameters of starch gelatinization endotherm from thermograms of starch with sucrose ester emulsifier (Deffenbaugh 1990).

T_0 (°C)				
Starch	0% SE	1% SE	2% SE	5% SE
Maize	66.66 ¹	66.53 ¹	66.49 ¹	66.42 ¹
Potato	59.74 ¹	59.83 ¹	59.75 ¹	59.61 ¹
Tapioca	63.54 ¹	63.97 ¹	64.03 ¹	63.90 ¹
Wheat	58.71 ¹	59.10 ¹	58.42 ¹	59.02 ¹
Waxy maize	69.03 ¹	68.40 ¹	68.40 ¹	68.13 ¹
T_p (°C)				
Starch	0% SE	1% SE	2% SE	5% SE
Maize	72.83 ¹	72.59 ¹	72.69 ¹	72.66 ¹
Potato	64.75 ¹	64.75 ¹	64.89 ¹	64.60 ¹
Tapioca	70.19 ¹	70.64 ¹	70.82 ¹	70.31 ¹
Wheat	63.69 ¹	63.72 ¹	63.30 ¹	63.67 ¹
Waxy maize	74.75 ¹	74.17 ¹	74.29 ¹	74.24 ¹
ΔH (J/g)				
Starch	0% SE	1% SE	2% SE	5% SE
Maize	13.44 ¹	11.50 ²	10.61 ²	10.66 ²
Potato	16.93 ¹	16.64 ¹	16.26 ^{1,2}	15.37 ²
Tapioca	18.19 ¹	15.28 ²	13.77 ¹	11.83 ¹
Wheat	10.61 ¹	9.58 ^{1,2}	9.33 ²	8.78 ²
Waxy maize	16.90 ¹	17.01 ¹	16.96 ¹	16.83 ¹

Superscripts 1 and 2 indicate significant difference ($p < 0.05$) within starch type

The relative thermal stability of starch/lipid complexes can be measured using DSC. Stability is a function of surfactant and type of starch. The measurements are important because they can predict rheological properties during gelatinization of starch systems (Eliasson, 1986b). Thermal stability and complex-melting enthalpy decrease as the fatty acid chain is interrupted by cis (Z) double bonds (Stute and Konieczny-Janda, 1983; Eliasson and Krog, 1985; Raphaelides and Karkalas, 1988). Chain length of the fatty acid does not affect the melting enthalpy and may or may not affect the thermal stability. Glycerol monostearate (GMS) forms very stable complexes with starch and has very significant effects on starch gelatinization. In Taro paste, sodium stearyl lactylate showed a larger melting endotherm than monoacylglycerols (Lai, 1998).

Physical properties of starch/surfactant complexes depend on conditions during crystallization. Multiple melting endotherms of complexes or shifting of endotherms during re-scanning indicate the presence of different crystal polymorphic forms. (Paton, 1987; Kugimiva and Donovan, 1981; Bulpin et al., 1982; Biliaderis and Galloway 1986; Eliasson, 1988). At the onset of gelatinization, association of the amylose chain with a ligand provides the conformational order to allow nucleation. Complexation during first heating may be incomplete due to restricted mobility of the amylose chain (Kugimiva and Donovan, 1981). Different polymorphic forms may occur simultaneously within a large crystal, which has folded back on itself (Eliasson, 1988). Complexes in folds or on the surface of the crystal have lower melting temperatures than those further inside the crystal.

4.5.6 Rheological Properties

Rheology is a discipline, which employs mechanical testing to measure the properties of materials under simulated conditions of use. In foods, the tests attempt to discover component interactions, which define the textural attributes, which make foods desirable to consumers (McClements, 2004; Chakrabarti, 2005).

The impact of starch/lipid complexes on rheological properties is often used to manage their functionality in high-starch foods. Important measurements are storage modulus, loss modulus and gel strength. In concentrated potato and wheat starches, dynamic modulus was higher in the presence of GMS and SSL (Kim and Walker, 1992; Keetels et al., 1996). Less gel stiffness occurred with these surfactants during storage. Amylopectin potato starch produced soft shear thinning gels in the presence of GMS and calcium stearyl lactylate (Nuessli et al., 2000). The Power Law and the Bird-Leider models were used to determine the effects of triacylglycerol and monoacylglycerol additions to starch pastes (Navarro et al., 1996). Triacylglycerol addition had no effect on wheat starch granules, but increased swelling capacity and decreased amylose leaching in corn starch granules. Waxy maize starch was unaffected by lipid addition. A recent rheological study suggests that amylose/lipid complexes may have utility as controlled lipid

release agents (Gelders et al., 2006). Modeling has also been used to investigate starch retrogradation (Farhat and Blanshard, 2001). Rheological measurements also determined functionality in some challenging bakery products, such as cake batter (Sakivan et al., 2004), microwaveable cakes (Seyhun et al., 2003), and frozen bread doughs (Ribotta et al., 2004).

4.5.7 Microstructure of Starch Systems

Observation of structure in model systems by microscopy techniques can provide information about functionality and interactions (Groves, 2005).

The light microscope may be used to examine the gross structure of a food matrix. In principle, objects $>200\ \mu\text{m}$ are detectable, but this level of resolution is difficult to achieve in practice. Interactions of surfactants with starch granules were observed in pastilles and yogurts by staining the ingredients (Titoria et al., 2004). Cross-polarized light highlights structures, which display birefringence. Sugar particles show up as white grains while starch granules show up as a chrematistic “Maltese cross.” When starch gelatinizes, the Maltese cross disappears. The rate of gelatinization can therefore be measured in model starch gels or high-starch products (Nuessli et al., 2000; Lamberti et al., 2004; Seetharaman et al., 2004). Confocal laser scanning microscopy (CLSM) is useful because sectioning of the sample results in a three dimensional image. For example, three dimensional images of corn starch granules were obtained (Bromley and Hopkinson, 2002).

If electrons are used instead of light, much greater resolution of the structure can be obtained. In scanning electron microscopy (SEM), the surface of the sample is observed by scattering of electrons. The sample may be pre-fractured to see interior structure. Transmission electron microscopy (TEM), electrons are passed through a thin section of the sample. Interactions of ingredients may be detected by effects on microstructure (Olsson et al., 2003; Walkenstrom et al., 2003; Tang et al., 2004). The effect of surfactants on microstructure of starch gels, and baked products have been reported (Toro-Vazquez et al., 2003; Ribotta et al., 2004; See-Kang and Supphantharica, 2006). TEM, for example, showed that fine-stranded amylose gels transformed into thicker strands by surfactants, but became spheres at higher surfactant concentrations (Richardson et al., 2004).

4.6 Surfactant/Hydrocolloid Interactions

Hydrocolloids also referred to as gums, have been widely used in the food industry as thickeners and agents for gel formation and particle suspension (Belitz et al., 2004b). They work cooperatively with surfactants to stabilize emulsions against flocculation and coalescence. Surfactants adsorb at the interface to provide steric

and electrostatic stabilization. Hydrocolloids, by increasing the viscosity of the aqueous phase, retard the mobility of dispersed phase droplets. For convenience, cellulose will be included in this discussion.

Hydrocolloids have very weak or no surface activity. Some of these products have no lipophilic groups in their molecular structure. However, some gums, such as guar and arabic, are surface-active because they contain a few percent of proteins, which contain some lipophilic amino acids. Others, such as pectin, contain small lipophilic groups bound to the polymeric chain by ester or ether linkages. Starches and hydrocolloids are chemically modified to include nonpolar functionality (Table 4.5). Surfactant/hydrocolloid interactions may be explained by competition for the interface (Garti et al., 1999).

Polar hydrocolloids may interact with the hydrophilic functional group of a surfactant through ionic or hydrogen bonds (Babak et al., 2000). Some of these complexes have been utilized to reduce total fat and to replace saturated fats with liquid oils (Reimer et al., 1993). The existence of these complexes is more difficult to establish than starch inclusion complexes. SEM and TEM showed significant strand thickening for monoacylglycerol/starch gels but not monoacylglycerol/cellulose gels. The blends, however, did provide texture and flavor advantages in fat-free products (Baer et al., 1991). Surfactant/hydrocolloid compositions are optimized in wheat bread formulations (Fast and Lechert, 1990; Mettler, 1992)

Table 4.5 Some chemically modified polysaccharides

Product	Added group	Typical applications
Starches		
Ethers	$-\text{OCH}_2\text{CHROH}$	Thickeners for refrigerated and canned foods, pie fillings
Carboxymethyl Starch Esters	$-\text{OCH}_2\text{CO}_2\text{H}$ $-\text{OPO}_3\text{H} \text{ } -\text{OCO}(\text{CH}_2)_n\text{COO}-$	Instant gelling products Improved freeze-thaw stability, Soups, bakery products, sauces
Cross-linked	Phosphates, Dicarboxylic acids	Products requiring stability at extremes of pH
Celluloses		
Alkylated	$-\text{OCH}_3$, $-\text{OCH}_2\text{CH}_3$, $-\text{OCH}_2\text{CH}(\text{CH}_3)\text{OH}$	Viscosity rises with temperature, Batters, dehydrated fruits, coatings
Carboxymethyl	$-\text{OCH}_2\text{CO}_2\text{H}$	Jellies, fillings, ice cream, bakery products, dehydrated foods
Hydrocolloids		
Propylene glycol alginate	$-\text{OCH}_2\text{CH}(\text{CH}_3)\text{OH}$	Suspending agent, salad dressings

4.7 Summary

Amphiphilic molecules are capable of interacting with simple saccharides, starches, and carbohydrates. Ionic, hydrogen, and/or hydrophobic bonding may form carbohydrate/surfactant complexes. A special example of hydrophobic (lipophilic) bonding is the formation of starch/surfactant inclusion complexes. These interactions may have a significant impact on the functional properties (such as, stickiness, viscosity, crystallization, or gel strength) of carbohydrates. Modern methods of colloid and emulsion science have led to descriptions of bimolecular interactions. However, correlation of this data to ingredient behavior in complicated food formulations can be quite difficult. This is particularly true when other surface-active agents or polyvalent ions are present. Application of experimental design is a useful tool to explain these effects in real foods.

Acknowledgments The author thanks Dr. Lynn Deffenbaugh, whose contribution from the First Edition served as a basis for the current chapter. Gratitude is also conveyed to Shirley Moore and Julie Hasenhuettl for their patient assistance with literature searches and preparation of the manuscript.

References

- Aronbine, J. S., et al. (1988). "Dynamic Control of Polymorphic Transformations in Triglycerides by Surfactants: The Button Syndrome." *J. Am. Oil Chem. Soc.* **65**: 1144–50.
- Azizi, M. H. and Rau, V. G. (2005). "Effect of Surfactant in Pasting Characteristics of Various Starches." *Food Hydrocolloids* **19**(4): 739–43.
- Babak, V. G., et al. (2000). "Hydrophobically Associating Alginate Derivatives: Surface Tension Properties of their Mixed Aqueous Solutions with Oppositely Charged Surfactants." *J. Colloid Interface Sci.* **225**(2): 505–10.
- Baer, C. C., et al. (1991). "Low Calorie Food Products Having Smooth Creamy Organoleptic Characteristics," U. S. Pat. 5,011,071, May 1, Kraft General Foods, Inc.
- Bahm, H., et al. (2006). *Rheology and Sedimentation Studies of Sugar Particle Dispersions in in Food Oils*. International Symposium on Food Rheology and Structure, Zurich, Institute of Food Science and Nutrition.
- Banks, W. and Greenwood, C. T. (1975). *Starch and Its Components*. Edinburgh, Scotland, Edinburgh University Press.
- Batres, L. V. and White, P. J. (1986). "Interaction of Amylopectin with Monoglycerides." *J. Am. Oil Chem. Soc.* **63**: 1537–40.
- Belitz, H. D., Grosch, W., and Schienberle, P. (2004a). Chapter 4: Carbohydrates. *Food Chemistry*. Berlin, Springer, 245–341.
- Belitz, H. D., Grosch, W., and Schienberle, P. (2004b). Polysaccharides. *Food Chemistry*. Berlin, Springer, 297–339.
- Biliaderis, C. G. and Galloway, G. (1986). "Crystallization Behavior of Amylose—V Complexes: Structure-Property Relationships." *Carbohydr. Res.* **189**: 31–48.
- Bourne, F. J., et al. (1960). "Interaction of Starch with Sucrose Stearates and Other Anti-Staling Agents," *J. Sci. Food Agric.* **11**: 101–9.
- Bromley, E. H. and Hopkinson, I. (2002). "Confocal Microscopy of a Dense Particle System." *J. Colloid Interface Sci.* **245**(1): 75–80.
- Bulpin, V., et al. (1982). "Physical Characterization of Amylose-Fatty Acid Complexes in Starch Granules and in Solution." *Starke* **34**: 335–9.

- Chakrabarti, S. (2005). Probing Ingredient Functionalities in Food Systems Using Rheological Methods. *Ingredient Interactions: Effects on Food Quality*. A. Gaonkar, A. M. McPherson, Boca Raton, CRC Press, 49–86.
- Chang, H.-J., et al. (2006). "Effect of Partial Gelatinization and Retrogradation on the Enzymatic Digestion of Waxy Rice Starch." *J. Cereal Sci.* **43**(3): 353–9.
- Conde-Petit, B. and Escher, F. (1992). "Gelation of Low Concentration Starch Systems Induced by Starch-Emulsifier Complexation." *Food Hydrocolloids* **6**(2): 223–9.
- Conde-Petit, B., and Escher, F. (1994). "Influence of Starch Complexation on the Aging Behavior of High Concentration Starch Gels." *Starke* **46**(5): 172–7.
- Deffenbaugh, L. B. (1990). "Characterization of the Interactions Between a Sucrose Fatty Acid Ester Emulsifier and Starches," Ph.D. Dissertation, University of Nebraska, Lincoln, NE.
- Deffenbaugh, L. B. and Walker, C. E. (1990). "Use of the Rapid Visco-Analyzer to Measure Starch Pasting Properties, Part II: Effect of Emulsifier and Sugar-Emulsifier Interactions," *Starke* **42**(3): 89–95.
- Dhonsi, D., and Stapley, A. G. F. (2006). "The Effect of Shear Rate, Temperature, Sugar and Emulsifier on the Tempering of Cocoa Butter." *J. Food Eng.* **77**(4): 936–42.
- Dickinson, E., et al. (2005). "Interactions in Dispersions of Sugar Particles in Food Oils: Influence of Emulsifier." *Food Hydrocolloids* **19**(3): 513–20.
- Donovan, J. W. (1979). "Phase Transitions of the Starch-Water System." *Biopolymers* **18**: 263–75.
- Ebeler, S. F. and Walker, C. E. (1984). "Effects of Various Sucrose Fatty Acid Ester Emulsifiers on High-Ratio White Layer Cakes." *J. Food Sci.* **49**: 380–8.
- Eliasson, A.-C. (1983). "Differential Scanning Calorimetry Studies on Wheat Starch Gluten Mixtures II: Effect of Gluten and Sodium Stearoyl Lactylate on Starch Crystallization During Aging of Wheat Starch Gels." *J. Cereal Sci.* **1**: 207–13.
- Eliasson, A.-C. (1985). "Starch Gelatinization in the Presence Of Emulsifiers." *Starke* **37**: 411–15.
- Eliasson, A.-C. (1986a). "On the Effects of Surface Active Agents on the Gelatinization of Starch—A Calorimetric Investigation." *Carbohydr. Polym.* **6**: 463–76.
- Eliasson, A.-C. (1986b). "Viscoelastic Behavior During the Gelatinization of Starch II: Effects of Emulsifiers." *J. Texture Stud.* **17**: 357–75.
- Eliasson, A.-C. (1988). "On the Thermal Transition of the Amylose-Cetyltrimethylammonium Bromide Complex." *Carbohydr. Res.* **172**: 83–95.
- Eliasson, A.-C. and Krogh, N. (1985). "Physical Properties of Amylose-Monoglyceride Complexes." *J. Cereal Sci.* **3**: 232–49.
- Eliasson, A.-C. and Ljunger, G. (1988). "Interactions Between Amylopectin and Lipid Additives During Retrogradation in a Model System." *J. Sci. Food Agric.* **44**: 353–61.
- Eliasson, A.-C., et al. (1988). "A Study of Starch-Lipid Interactions for Some Native and Modified Maize Starches." *Starke* **40**: 95–100.
- Evans, I. D. (1986). "An Investigation of Starch/Surfactant Interactions Using Viscometry and Differential Scanning Calorimetry." *Starke* **38**: 227–35.
- Fardet, A., et al. (1999). "In Vivo Starch Degradation from Wheat Bread Products in the Presence of Lipid Complex Emulsions." *Nutr. Res.* **19**(6): 881–92.
- Farhat, L. A. and Blanshard, J. M. V. (2001). Modeling the Kinetics of Starch Retrogradation. *Bread Staling*. P. Chunacholi, V. Pand-Vodovotz, Boca Raton, CRC Press, 163–72.
- Fast, U. and Lechert, H. (1990). "Nuclear Magnetic Resonance Investigation of Water Binding During Wheat Bread Production with Particular Attention to Emulsifier and Hydrocolloid Influences." *Dtsch. Lebensmitt. Rundsch.* **86**(11): 355 Notes.
- Favor, H. H. and Johnston, N. R. (1947). "Effect of Polyoxyethylene Stearate on the Crumb Softening of Bread," *Cereal Chem.* **24**: 346–55.
- Ferry, A. J., et al. (2006). "Viscosity and Flavour Perception: Why is Starch Different from Hydrocolloids." *Food Hydrocolloids* **20**(6): 855–62.
- Gaonkar, A. and McPherson, A. (Ed.) (2005). *Ingredient Interactions: Effects on Food Quality*. Food Science and Technology. Boca Raton, CRC Press.
- Gaonkar, A. G. (1989). "Interfacial Tensions of Vegetable Oil-Water Systems: Effect of Oil Purification." *J. Am. Oil Chem. Soc.* **66**: 1090–7.

- Garti, N., et al. (1999). "Competitive Adsorption in O/W Emulsions Stabilized by the New Portulaca Oleracea Hydrocolloid and Nonionic Emulsifiers." *Food Hydrocolloids* **13**(2): 139–44.
- Gelders, G. G., et al. (2006). "Amylose-Lipid Complexes as Controlled Lipid Release Agents during Starch Gelatinization and Pasting." *J. Agric. Food Chem.* **54**(4): 1493–9.
- Ghiasi, K., et al. (1982a). "Gelatinization of Wheat Starch 1, Excess Water Systems." *Cereal Chem.* **59**: 81–5.
- Ghiasi, K., et al. (1982b). "Gelatinization of Wheat Starch, III: Comparison by Differential Scanning Calorimetry and Light Microscopy." *Cereal Chem.* **59**: 258–62.
- Ghosh, V., et al. (2005). "Moisture Migration Through Chocolate-Flavored Confectionery Coatings." *J. Food Eng.* **66**(2): 177–86.
- Gray, V. M. and Schoch, T. J. (1962). "Effects of Surfactants and Fatty Adjuncts on the Swelling and Solubilization of Granular Starches." *Starke* **14**: 239–46.
- Groves, K. (2005). *Microscopy: A Tool to Study Ingredient Interactions in Food. Ingredient Interactions: Effects on Food Quality*. A. Gaonkar, A. McPherson, Boca Raton, CRC Press, 21–49.
- Gudmondsson, M. and Eliasson, A. C. (1990). "Retrogradation of Amylopectin and the Effects of Amylose and Added Surfactants and Emulsifiers." *Carbohydr. Polym.* **13**: 295–315.
- Hahm, D. E. and Hood, L. F. (1987). "Factors Influencing Corn Starch/Lipid Complexing." *Cereal Chem.* **64**: 81–5.
- Hahnel, W., et al. (1995). "Investigations into the Properties of Emulsifiers in Yeast Leavened Dough by Means of Infrared Spectroscopy II: Experiments on the Interaction of Emulsifiers with Starch and Flour in Dough." *Z. Lebensm. Unters Frosch* **200**: 244–46.
- Hanna, T. G. and Lelievre, J. (1975). "An Effect of Lipid on the Enzymatic Degradation of Wheat Starch." *Cereal Chem.* **52**(5): 697–701.
- Holm, J., et al. (1983). "Digestibility of the Amylose/Lipid Complexes in vitro and in vivo." *Starke* **35**: 294–7.
- Hoover, R. and Hadziyev, D. (1981). "Characterization of Potato Starch and its Monoglyceride Complexes." *Starke* **33**: 290–300.
- Jane, A. L., et al. (1985). "13-C NMR Study of the Conformation of Helical Complexes of Amylodextrin and Amylose in Solution." *Carbohydr. Res.* **140**: 21–35.
- Johansson, D. and Bergenstahl, B. (1992a). "The Influence of Food Emulsifiers on Fat and Sugar Dispersions in Oils: 1. Adsorption Sedimentation." *J. Am. Oil Chem. Soc.* **69**: 705–17.
- Johansson, D. and Bergenstahl, B. (1992b). "The Influence of Food Emulsifiers on Fat and Sugar Dispersions in Oils: 2. Rheology, Colloidal Forces." *J. Am. Oil Chem. Soc.* **69**: 718–27.
- Johansson, D. and Bergenstahl, B. (1992c). "The influence of Food Emulsifiers on Sugar Dispersions in Oils: 3. Water Content, Purity of Oils." *J. Am. Oil Chem. Soc.* **69**: 728–33.
- Johnson, J. M., et al. (1990). "Lipid Binding of Modified Corn Starches Studied by Electron Spin Resonance." *Cereal Chem.* **67**: 236–40.
- Karkalas, J. and Raphaelides, S. (1986). "Quantitative Aspects of Amylose-Lipid Interactions." *Carbohydr. Res.* **157**: 215–34.
- Keetels, C. G. M., et al. (1996). "Effect of Lipid Surfactants on the Structure and Mechanics of Concentrated Starch Gels and Starch Bread." *J. Cereal Sci.* **24**(1): 32–45.
- Kim, C. S. and Walker, C. E. (1992). "Changes in Starch Pasting Properties due to Sugars and Emulsifiers as Determined by Viscosity Measurements." *J. Food Sci.* **57**(4): 1009–13.
- Kim, H.-O. and Hill, R. D. (1985). Effect of Cycloheptaamylose on Starch/Lipid Interaction. *New Approaches to Research on Cereal Carbohydrates*. Hill, R. D. Hill, L., Amsterdam, Elsevier, 81–8.
- Kim, Y. J. and Robinson, R. J. (1979). "Effect of Surfactants on Starch in a Model System." *Starke* **31**: 293–300.
- Krog, N. (1971). "Amylose Complexing Effect of Food Grade Emulsifiers." *Starke* **23**: 206–10.
- Krog, N. (1973). "Influence of Food Emulsifiers on Pasting Temperature and Viscosity of Various Starches." *Starke* **25**: 22–7.
- Krog, N. (1981). "Theoretical Aspects of Surfactants in Relation to Their Use in Bread Making." *Cereal Chem.* **58**: 158–64.
- Krog, N. and Nybo-Jensen, B. (1970). "Interaction of Monoglycerides in Different Physical States with Amylose and Their Anti-Firming Effects in Bread." *J. Food Technol.* **5**: 77–87.

- Kugimiva, M. and Donovan, J. W. (1981). "Calorimetric Determination of the con-Calorimetric Study." *Starke* **35**: 265–70.
- Legendiik, J. and Pennings, H. (1970). "Relation Between Complex Formation of Starch with Monoglycerides and the Firmness of Bread." *Cereal Sci. Today* **15**: 354–65.
- Lai, H.-M. (1998). "17O NMR and DSC for Studying Quality of Taro Paste as Affected by Processing and Storage." *Lebens. Wiss. Technol.* **31**(1): 57–63.
- Lamberti, M., et al. (2004). "Starch Transformation and Structure Development in Production and Reconstitution of Potato Flakes." *Lebensm. Wiss. Technol.* **37**(4): 417–27.
- Larsson, K. (1980). "Inhibition of Starch Gelatinization by Amylose/lipid Complex Formation." *Starke* **32**: 125–6.
- Lopes de Silva, J. A., et al. (2002). "Effects of Gelatinization and Starch-Emulsifier Interactions on Aroma Release from Starch-Rich Model Systems." *J. Agric. Food Chem.* **50**(7): 1076–84.
- Lund, D. (1984). "Influence of Time, Temperature, Moisture, Ingredients, and Processing Conditions on Starch Gelatinization." *CRC Crit. Rev. Food Sci. Nutr.* **20**(4): 249–73.
- Maier, H. C., et al. (1987). "Thermostable Binding of Aroma Compound to Starch, I: Binding by Freeze Drying." *Starke* **39**: 126–31.
- Matsunaga, A. and Kainoma, K. (1986). "Studies on the Retrogradation of Starch in Starchy Foods, Part 3: Effect of the Addition of Sucrose Fatty Acid Ester on the Retrogradation of Corn Starch." *Starke* **38**: 1–6.
- McClements, D. J. (2004). Chapter 8: Emulsion Rheology. *Food Emulsions: Principles, Practices, and Techniques*. Boca Raton, CRC Press, 341–88.
- Mercier, C., et al. (1980). "Formation of Amylose-Lipid Complexes by Twin-Screw Extrusion Cooking of <anioc Starch," *Cereal Chem.* **57**: 4–9.
- Mettler, E. A. (1992). "The Effect of Emulsifiers and Hydrocolloids in the Optimization of the Functional Properties of Wheat Breads: Part 7, Optimization for Wheat Flour Bread." *Getreide Mehl und Brot* **46**(8): 234–41.
- Mikus, F. F., et al. (1946). "The Complexes of Fatty Acids with Amylose." *J. Am. Chem. Soc.* **168**: 1115–23.
- Miles, M. J., et al. (1985). "The Roles of Amylose and Amylopectin in the Gelation and Retrogradation of Starch." *Carbohydr. Res.* **135**: 271–81.
- Mitchell, W. A. and Zalman, E. (1951). "The Effect of Fatty Acids on Starch and Flour Viscosity." *Trans. Am. Assoc. Cereal Chem.* **9**: 64–79.
- Mitolo, J. J. (2005). Starch Selection and Interaction in Foods. *Ingredient Interactions: Effects on Food Quality*. A. Gaonkar, A. McPherson, Boca Raton, CRC Press, 140–164.
- Miura, M., et al. (1992). "Influence of Addition of Polyols and Food Emulsifiers on the Relative Retrogradation Rate of Starch." *Food Struct.* **11**: 225–36.
- Moorthy, S. N. (1985). "Effect of Different Types of Surfactants on Cassava Starch Properties." *J. Agric. Food Chem.* **33**: 1227–33.
- Navarro, A. S., et al. (1996). "Modeling of Rheological Behavior in Starch-Lipid Systems." *Lebensm. Wiss. Technol.* **29**(7): 632–9.
- Neszemlyi, A., et al. (1987). "Bimolecular Modeling as an Interactive Program for the Visualization and Modeling of Carbohydrate (Starch and Oligosaccharide) Complexes in Isolation." *Starke* **39**: 393–6.
- Nolan, N. L., et al. (1986). "An Electron Spin Resonance Study of Native and Gelatinized Starch Systems." *Cereal Chem.* **63**: 287–91.
- Nuessli, J., et al. (2000). "Rheology and Structure of Amylopectin Potato Starch Dispersions Without and With Emulsifier Addition." *Starke* **52**(1): 22–7.
- Olkku, T. and Rha, C. (1978). "Gelatinization of Starch and Wheat Flour a Review." *Food Chem.* **3**: 293–317.
- Olsson, C., et al. (2003). *Microstructural Evolution of Mixed Gels and their Rheological Behaviour*. Food Colloids, Biopolymers, and Materials, Wageingen, Royal Society of Chemistry.
- Osman, E. M. (1967). Starch in the Food Industry. *Starch: Chemistry and Technology*. R. L. Whistker, E. F. Paschall, New York, Academic Press, 2: 163–215.

- Osman, E. M. and Dix, M. R. (1960). "Effect of Fat and Nonionic Surface-Active Agents on Starch Pastes," *Cereal Chem.* **37**: 464–75.
- Osman, E. M., et al. (1961). "Complexes of Amylose with Surfactants," *Cereal Chem.* **38**: 440–63.
- Paton, D. (1987). "Differential Scanning Calorimetry of Oat Starch Paste." *Cereal Chem.* **164**: 384–9.
- Pearce, L. M., et al. (1985). "Application of Electron Spin Resonance Techniques to Model Starch Systems." *Food Microstruct.* **4**: 83–8.
- Pomeranz, Y., et al. (1969). "Improving Bread-making Properties with Glycolipids, I: Improving Soy Products with Sucroesters," *Cereal Chem.* **46**: 503–11.
- Preininger, M. (2005). Interactions of Flavor Components in Foods. *Ingredient Interactions: Effects on Food Quality*. A. Gaonkar, A. McPherson. Boca Raton, CRC Press, 499–503.
- Raphaelides, S. and Karkalas, J. (1988). "Thermal Dissociation of Amylose-Fatty Acid Complexes." *Carbohydr. Res.* **172**: 65–82.
- Reimer, R., et al. (1993). "Ionic Complexes of Ionizable Emulsifiers with Ionizable Polypeptides and/or Ionizable Hydrocolloids." *PCT Int. Appl.* WO 9321784, Nov. 11, Pfizer, Inc. USA: 37.
- Ribotta, P. D., et al. (2004). "Effect of Emulsifier and Guar Gum on Microstructural, Rheological, and Baking Performance of Frozen Bread Dough." *Food Hydrocolloids* **18**(2): 305–13.
- Richardson, G., et al. (2004). "Differences in Amylose Aggregation and Starch Gel Formation with Emulsifiers." *Carbohydr. Polym.* **58**(1): 7–13.
- Rilsom, T., et al. (1984). "Amylose-Complexing Capacity of cis and trans Unsaturated Monoglycerides in Relation to their Functionality in Bread." *J. Cereal Sci.* **2**: 105–18.
- Ring, S. C. (1985). "Some Studies on Starch Gelation." *Starke* **37**: 80–3.
- Roach, R. R. and Hosene, R. C. (1995a). "Effect of Certain Surfactants on the Swelling, Solubility, and Amylograph Consistency of Starch," *Cereal Chem.* **72**: 571–7.
- Roach, R. R. and Hosene, R. C. (1995b). "Effect of Certain Surfactants on the Starch in Bread," *Cereal Chem.* **72**: 578–87.
- Rouset, P., et al. (2002). "Effect of Emulsifiers on Surface Properties of Sucrose by Inverse Gas Chromatography." *J. Chromatogr. A* **969**(1–2): 97–101.
- Rutschmann, M. A. and Solms, J. (1990). Flavors and Off-flavors. *Developments in Food Science*. Amsterdam, Elsevier, 991–1010.
- Sakivan, O., et al. (2004). "Influence of Fat Content and Emulsifier Type on the Rheological Properties of Cake Batter." *J. Euro. Food Res. Technol.* **219**(6): 635–8.
- Schmidt, E. and Maier, H. C. (1987). "Thermostable Binding of Aroma Compounds to Starch, II: Binding of Menthol by Autoclaving." *Starke* **39**: 203–7.
- Schoch, T. and Williams, C. (1944). "Adsorption of Fatty Acid by the Linear Component of Corn Starch." *J. Am. Chem. Soc.* **66**: 1232–3.
- Schoch, T. J. and French, D. (1947). "Studies on Bread Staling, 1: The Role of Starch." *Cereal Chem.* **24**: 231–49.
- See-Kang, V. and Suphantharica, M. (2006). "Influence of pH and Xanthan Gum Addition on Freeze-Thaw Stability of Tapioca Starch Pastes." *Carbohydr. Polym.* **65**(3): 371–80.
- Seetharaman, K., et al. (2004). "Role of Water in Pretzel Dough Development and Finished Product Quality." *Cereal Chem.* **81**: 336–40.
- Servais, C., et al. (2004). "Determination of Chocolate Viscosity." *J. Texture Stud.* **34**: 467–97.
- Seyhun, N., et al. (2003). "Effects of Different Emulsifier Types, Fat Contents, and Gum Types on the Retardation of Staling of Microwaved Cakes." *Nahrung/Food* **47**(4): 248–51.
- Slaughter, S. L., et al. (2001). "An Investigation of the Action of Porcine Pancreatic alpha-Amylase on Native and Gelatinized Starches." *Biochim. Biophys. Acta* **525**(1–2): 29–36.
- Staeger, G., et al. (1988). Formation of Starch Inclusion Compounds During Extrusion Cooking. *Frontiers of Flavor*. G. Charalamhous. Amsterdam, Elsevier, 639–54.
- Strandine, E. F., et al. (1951). "Effect of Monoglycerides on Starch, Flour, and Bread: A Microscopic and Chemical Study," *Cereal Chem.* **28**: 449–62.
- Stute, V. R. K. and Konieczny-Janda, G. (1983). "DSC Investigation of Starches, Part II: Investigations on Starch/lipid Complexes." *Starke* **35**: 340–47.

- Szezodrak, J. and Pomeranz, Y. (1992). "Starch Lipid Interactions and Formation of Resistant Starch in High Amylose Barley." *Cereal Chem.* **69**(6): 626–32.
- Tang, H., et al. (2004). "Relationship Between Functionality and Structure in Barley Starches." *Carbohydr. Polym.* **57**(2): 45–52.
- Tang, H., et al. (2005). "Functionality of Starch Granules in Milling Fractions of Normal Wheat Grain." *Carbohydr. Polym.* **59**(1): 11–17.
- Titoria, P. M., et al. (2004). "Starch-Emulsifier Gelling Systems: Applications in Pastilles and Yoghurts," Research Report RR850, Leatherhead Food International, Ltd.
- Toro-Vazquez, J.F., et al. (2003). "Interaction of Granular Maize Starch with Lysophosphatidylcholine Evaluated by Calorimetry, Mechanical and Microscopy Analysis." *J. Cereal Sci.* **38**(3): 269–79.
- Twillman, T. J. and White, R. J. (1988). "Influence of Monoglycerides on the Textural Shelf Life and Dough Rheology of Corn Tortillas." *Cereal Chem.* **65**: 253–7.
- Van Lonkhuysen, H. and Blankestijn, J. (1974). "Interaction of Monoglycerides with Starches." *Starke* **26**: 337–43.
- Vilhelmson, O. and Miller, K. (2002). "Humectant Permeability Influences Growth and Compatible Solute Uptake by *Staphylococcus aureus* Subjected to Osmotic Stress." *J. Food Prot.* **65**(6): 1008–15.
- Walkenstrom, P., et al. (2003). "Microstructure and Rheological Behaviour of Alginate/Pectin Mixed Gels." *Food Hydrocolloids* **17**: 593–603.
- Warshaw, H. S. and Kukami, K. (2004). *ADA Complete Guide to Carb Counting*, American Diabetes Association, Washington.
- Zobel, H. F. (1984). Gelatinization of Starch and Mechanical Properties of Starch Pastes. *Starch: Chemistry and Technology*. R. L. Whistler, J. N. BeMiller, E. E. Paohall, Boca Raton, Academic Press, 285–311.

Chapter 5

Protein/Emulsifier Interactions

Tommy Nylander, Thomas Arnebrant, Martin Bos, and Peter Wilde

5.1 Introduction

Many food emulsions are more complex than a simple colloidal dispersion of liquid droplets in another liquid phase. This is mainly because the dispersed phase is partially solidified or the continuous phase may contain crystalline material, as in ice cream. However, one characteristic that all emulsions have in common is that they are (thermodynamically) unstable. The four main mechanisms that can be identified in the process of breaking down an emulsion are creaming, flocculation, coalescence, and Ostwald ripening. There are two ways in which the process of breakdown of an emulsion can be influenced. First, use of mechanical devices to control the size of the dispersion droplets and second, the addition of stabilizing chemical additives like low molecular weight emulsifiers or polymers to keep it dispersed. The main purpose of the latter is to prevent the emulsion droplets flocculating and from fusing together (coalescence), often achieved by repulsive droplet/droplet interactions. These interparticle interactions are determined mainly by the droplet surface, which is coated with emulsifiers, often surface-active components of biological origin like proteins, mono- and diglycerides, fatty acids, or phospholipids. The forces most commonly observed are electrostatic double layer, van der Waals, hydration, hydrophobic, and steric forces. They are responsible for many emulsion properties including their stability.

The complex mechanisms involved in formation, stabilization, and destabilization of emulsions make fundamental studies on applied systems difficult. One approach has therefore been to clarify the basic physical and chemical properties of emulsions by the study of simpler model systems. The adsorption behavior of single-emulsion components like proteins, fatty acids, surfactants, or phospholipids at liquid/air or liquid/liquid interfaces have given information about surface activity, adsorbed amounts, kinetics, conformation, and surface rheology. The development of experimental techniques has made it possible to extend these studies to multicomponent systems. This has provided further information concerning competitive adsorption, displacement, and complex formation, which can be related to emulsion and foam stability.

For further information concerning the physicochemical factors affecting the emulsion structure as well as characterization of food emulsion stability, the reader

is referred to the reviews of (Dickinson and Stainsby, 1982; Dickinson, 1996; Wilde, 2000; Bos and van Vliet, 2001a; Benichou et al., 2002; Dickinson, 2003), and for the principles of emulsion formation to the book of Walstra (2003) along with the other chapters in this book. In this chapter we will focus on the molecular interactions between proteins and other surface-active components present at the interface of the emulsion droplets. Understanding the interaction between these emulsifier components is the key to increasing the emulsion stability as well as to be able to tailor the structure of these systems. Various surface-active components like lipids, low molecular weight (LMW) surfactants, and even phospholipids will be regarded as emulsifiers. We will first discuss the stability of the protein in solution, which is an important factor for their behavior in emulsion systems. Although the behavior at liquid/liquid and liquid/air interfaces can be best compared with the situation in an emulsion or foam, we will also discuss some relevant studies concerning the solid/liquid interface as well as the effect of emulsifiers on the solution behavior of proteins.

Surface tension measurements have often been used to study protein–lipid interaction, (cf., Nishikido et al., 1982; Ericsson and Hegg, 1985; Fainerman et al., 1998; Miller et al., 2000a; Vollhardt and Fainerman, 2000). However, it must be born in mind that any impurity with higher surface activity than the studied components will accumulate at the interface giving a lowering of the surface tension (Miller and Lunkenheimer, 1986; Lunkenheimer and Miller, 1987; Lunkenheimer and Czichocki, 1993) and thus affect the interpretation of the data. As an example, the presence of impurities, e.g., fatty acids, bound to β -lactoglobulin did have a profound effect on the interfacial behavior of mixtures with Tween 20, as judged from surface elasticity measurements at the air–aqueous interface (Clark et al., 1995). It was observed that the film containing purified β -lactoglobulin could maintain a more rigid film, at a much higher concentration of Tween 20 as compared to the sample containing impurities. A number of other techniques can also be used to study protein–emulsifier interactions, including surface film balance, ellipsometry, Brewster angle microscopy (BAM), circular dichroism (CD), differential scanning calorimetry (DSC), surface rheology, fluorescence spectroscopy, and neutron reflectivity. It is beyond the scope of this chapter to discuss these techniques in detail, but when necessary a brief explanation will be given.

The link between the molecular interactions between emulsifier components and the properties of food emulsions will be discussed in the last section of this chapter.

5.2 Properties of Proteins and Emulsifiers

5.2.1 Protein Structure and Stability

Relevant aspects of protein aggregation and unfolding are briefly discussed as well as the effects of protein structure (random coil proteins versus globular).

An important consequence of protein–lipid interaction is the effect on stability of the protein in solution as well as on its behavior at interfaces. When discussing the stability of proteins, we may distinguish between the conformational stability of proteins and aggregation/precipitation phenomena due to reduced solubility at pH close to the isoelectric point, at high ionic strength (salting out), and/or caused by specific binding of ions (e.g., the formation of calcium bridges) or lipids. Although the two phenomena usually are connected, aggregation/precipitation can occur without major conformational changes of the protein (Tanford, 1967). The conformational stability of a protein, which of course has no meaning for proteins lacking secondary structure, can be estimated by circular dichroism (cf., Creighton, 1993), compressibility measurement (cf., Gekko and Hasegawa, 1986) and calorimetry (cf., Privalov, 1979; Privalov, 1982; Privalov and Gill, 1988). The stabilization of the protein structure has been extensively reviewed by a number of authors (cf., Privalov, 1979; Privalov, 1982; Privalov and Gill, 1988; Creighton, 1990; Dill, 1990; Ponnuswamy, 1993), and we will only focus on some aspects of significance in emulsion systems.

The native protein structure is a consequence of a delicate balance of forces including electrostatic forces, hydrogen bonding, van der Waals forces, conformational entropy and so-called hydrophobic interactions (cf., Richards, 1977; Pace et al., 1981; Privalov and Gill, 1988; Dill, 1990; Ponnuswamy, 1993). The amino acid sequence of the polypeptide chain (the primary structure) will determine the folding into structural units (the secondary structure) and the association of structural units into domains, tertiary and quaternary structures, gives each protein the unique conformation that is required for its function and activity. Naturally, cross-links, such as disulphide bridges, increase the stability of a protein.

The interior of a globular protein is very densely packed, having a quite constant mean packing density (0.74), a value also found for crystals of small organic molecules (Richards, 1977). Thus, van der Waals forces and hydrogen bonding, which are short range interactions, play an important role for the stability of folded proteins (Privalov and Gill, 1988). As first pointed out by Kauzmann (Kauzmann, 1959), it is clear that the so-called hydrophobic interactions play an important role in stabilizing the protein structure. The nonpolar amino acid residues will provide a strong driving force for folding, leading to an accumulation of hydrophobic residues in the core of the protein molecule. The polar amino acid residues (uncharged and charged) will interact favorably with an aqueous solvent and will consequently be located on the outside of the protein. The nature of hydrophobic interactions in this context is not yet fully understood (cf., Privalov and Gill, 1988; Dill, 1990; Ponnuswamy, 1993), since it still is difficult to analyze them separately from other forces contributing to the stabilization of the protein structure (Privalov and Gill, 1988).

It is important to bear in mind that proteins are only marginally stable at room temperature. This means that the exchange of only one amino acid residue, by for instance genetic engineering, might destabilize or stabilize the protein considerably (Matsumura et al., 1988; McGuire et al., 1995b). This can also be achieved by lipid, surfactant and by denaturing agents like urea. In addition, some proteins have as part of their biological role, specific binding sites for lipids. These binding sites can even be specific for a certain class of lipids. Thus it is important to consider protein–lipid

interactions in relation to the features of each individual protein. As discussed extensively by Norde et al. (Norde, 1986; Haynes and Norde, 1994; Norde, 2000), the delicate balance between forces that stabilize and destabilize the protein might be shifted in the proximity of an interface, leading to unfolding upon adsorption. Also the lipid–aqueous interface of self-assembled structures is also an important type of interface where unfolding of the interacting protein can occur. The loss of entropy upon protein folding is the main force counteracting the stabilization of the protein structure (Dill, 1990). Thus, unfolding upon adsorption is an entropically favored process (Norde, 1986; Haynes and Norde, 1994; Norde, 2000). Furthermore, at an interface the unfolded hydrophobic domains might be oriented in such a way that their exposure to the aqueous environment is minimized. In fact, Norde argues that the entropy gained by the unfolding of the protein upon adsorption can be a significant driving force for adsorption (Norde, 1986; Haynes and Norde, 1994; Norde, 2000). However, they also observed that adsorption of protein on apolar surfaces might lead to an increase in the amount of the protein secondary structure as observed for enzymes like α -chymotrypsin and serine proteinase savinase on Teflon (Maste et al., 1997; Zoungrana et al., 1997; Norde, 2000).

The folding and unfolding of proteins have been shown, under certain conditions, to occur via an intermediate state, the so-called molten globule state (Dolgikh et al., 1981; Ohgushi and Wada, 1983; Dolgikh et al., 1985; Kuwajima, 1989; Ptitsyn et al., 1990; Dickinson and Matsumura, 1994). This state, which is somewhere between the native and completely unfolded state, is characterized by a retained secondary structure, but with a fluctuating tertiary structure. The protein molecule is also more expanded and is exposing more hydrophobic domains. The molten globule state is hard to detect by calorimetric measurements, since the unfolding of the molten globule is accompanied with little or no heat absorption (Kuwajima, 1989). As discussed by Dickinson and Matsumura (Dickinson and Matsumura, 1994), the molten globule state can be achieved in a number of ways, as pH-changes, increase of temperature, the use of denaturation agents, breaking of disulphide bridges and removal of ligands or cofactors bound to the protein. For instance it has been reported that the calcium free form of α -lactalbumin is more hydrophobic (Lindahl and Vogel, 1984). Proteins might also adopt a molten globule state when interacting with an interface. In fact, it was found that α -lactalbumin was more surface active under conditions where it exists in the molten globule state (Engel et al., 2002). This is demonstrated in Fig. 5.1 showing that the adsorption of α -lactalbumin is enhanced as pH is reduced so that the protein structure tends towards that of the molten globule state. It has been proposed that the molten globule state of the protein may be required for the translocation of proteins across biological membranes (Bychokova et al., 1988; van der Goot et al., 1991). The importance of the protein structure in this context was provided by Hanssens and Van Cauwelaert (1978), who studied the penetration of α -lactalbumin in monolayers of DPPC and cardiolipin at physiological pH (pH 7.4) and at pH 4.6 with and without calcium. Indeed, penetration occurred at low pH, when the protein is supposed to be in the molten globule state and was prevented if the protein was adsorbed from a calcium solution (Hanssens and Van Cauwelaert, 1978). The conformation of the protein does not always change significantly when interacting with the lipid monolayer. By recording

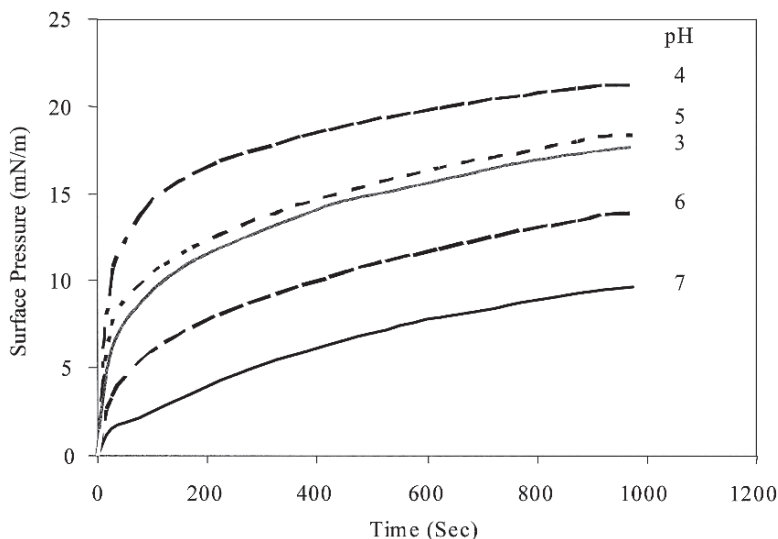

Fig. 5.1 Surface pressure of adsorbing α -lactalbumin as a function of solution pH. The increase in adsorption rates as pH is reduced is initially due to reduction in inter-molecular repulsion as the pH approaches the isoelectric point for α -lactalbumin (pH 4.2). Below this pH, the enhanced adsorption is increasingly due to molecular unfolding as the protein structure tends towards the molten globule state

CD-spectra for β -lactoglobulin, α -lactalbumin or BSA bound to mixed monolayers of POPC and POPG and transferred to a quartz plate, Cornell et al. showed (Cornell and Patterson, 1989; Cornell et al., 1990) that the protein bound to the lipid monolayer was similar to the one recorded in solution.

Protein properties as conformation, charge distribution, association and activity are also strongly influenced by environmental condition, e.g., pH, ionic strength, type of ion and temperature. In this context it is important to point out the effect of type, valence and ionic strength of added electrolyte. As discussed by Ninham et al. this can have profound effect on interactions involving proteins and other polyelectrolytes, in particular under physiologically relevant conditions (Boström et al., 2001; Boström et al., 2002; Ninham, 2002). They argue that the present theory is not adequate to distinguish between van der Waals interactions and electrostatic interactions under these conditions.

5.2.2 Emulsifiers and Their Phase Behavior

Different types of emulsifiers are defined I) aqueous soluble, surfactant type and II) lipids with low aqueous solubility. The self-assembled structures formed by the different types of surfactants are discussed.

Lipids can be divided into two major groups: polar and nonpolar lipids. The non-polar lipids, primarily the triglycerides, have small polar groups, and hence show only limited interaction with aqueous systems. The polar lipids, however, with large charged or uncharged polar groups, giving these lipids amphiphilic nature, associate in aqueous systems. The common feature for the self-assembly of the polar lipids in aqueous environment is the formation of a polar interface, which separates the hydrocarbon and water regions. The hydrocarbon chains can exist either in a fluid state, as in liquid crystalline phases, or in a solid state, as in the lipid gel phases (Larsson, 1994). Generally, the melting of the chains in an aqueous environment occurs at a much lower temperature compared to the melting of the pure lipid.

It is convenient to distinguish between surfactants/polar lipids according to their water solubility:

1. Polar lipids and synthetic analogues, i.e., surfactants, that are water soluble in monomeric and micellar form,
2. Polar lipids with very low water solubility, but with the ability to swell into liquid crystalline phases.

The water-soluble polar lipids (e.g., ionized fatty acids, bile salts, and synthetic surfactants, charged or uncharged) have monomeric solubility in the millimolar range and form micelles at higher concentrations. The critical micelle concentration (cmc) is considered to be a narrow concentration range, within which aggregates start to form by a strong cooperative process (Lindman and Wennerström, 1980). The driving force for micelle formation is the hydrophobic interaction (cf., Tanford, 1980). The cmc for single-chain amphiphiles decreases with increasing chain length; and for ionic amphiphiles cmc also depends on the ionic strength, as addition of salt reduces the electrostatic repulsion between the charged head groups. Increased temperature has, however, only a moderate influence on cmc, once the temperature has exceeded the critical temperature, where the monomer solubility is equal to the cmc (Krafft temperature).

A common feature of the two classes of polar lipids is the tendency to form lyotropic liquid crystalline phases. A summary of some of the different liquid crystalline phases that can occur is given in Fig. 5.2. With decreasing water content, the phase behavior of polar lipids often follows the sequence: hexagonal phase (H_I) → lamellar phase (L_α) for water soluble lipids and lamellar phase (L_α) → reversed hexagonal phase (H_{II}) for lipids with low water solubility. At low water content an inverse micellar structure, the L_2 phase, is formed, in which the hydrocarbon chains form the continuous medium and the aqueous medium is present within the micelles. Cubic liquid crystalline phases (Q) often occur in between these phases. Phase transitions can also occur with changes in temperature; with increasing temperature the sequence of thermal transitions is usually the same as with decreased water content. The formation of a particular phase can in many cases be understood by looking at the geometric packing properties of the amphiphilic molecule in the particular environment (Israelachvili et al., 1976; Mitchell and Ninham, 1981), that is the cross-section area of the polar head group in relation to that of the acyl chain. This property can be expressed by the so called packing parameter (v/al), which is defined

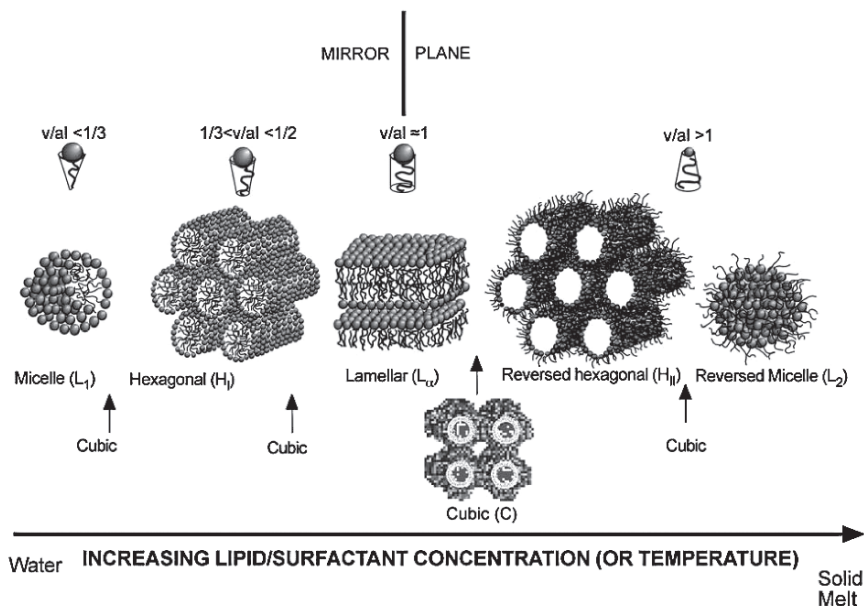

Fig. 5.2 Commonly formed association structures by polar lipids. Phase transitions can be induced by changes in water content, temperature or by interaction with other solution components, like proteins. The lamellar liquid crystalline phase (L_{α}) can be regarded as the mirror plane, where the aggregates are of the “oil-in-water” type on the water rich side and of “water-in-oil” type on the water poor side (Fontell, 1992). On both the water rich and water poor sides of the L_{α} there are two possible locations for cubic phases. Other “intermediate phases” may also occur. The formation of a particular phase can in many cases be understood by looking at the geometric packing properties of the amphiphilic molecule in the particular environment (Israelachvili et al. 1976; Mitchell and Ninham, 1981). This property can be expressed by the so called packing parameter (v/al), which is defined as the ratio between the volume of the hydrophobic chain (v) and the product of the head group area (a) and the chain length (l)

as the ratio between the volume of the hydrophobic chain (v) and the product of the head group area (a) and the chain length (l). The packing parameter for a particular environment will determine the curvature of the interface and thus the particular phase. Generally speaking (see Fig. 5.2), a value of the packing parameter lower than unity (cone shaped amphiphile) facilitates the formation of structures where the polar interface is curved towards the hydrocarbon phase, i.e., structures of “oil-in-water” type (L_1 , H_1). On the other hand a value larger than one (reversed cone shaped amphiphile) will give the reverse curvature and favor “water-in-oil” structures like H_{II} and L_2 . When the packing parameter is changed by for instance the change of ionic strength, temperature or the addition of other molecules like proteins, phase transitions will ultimately arise. Increased temperature, e.g., will increase chain mobility and thereby increase the volume of the lipophilic part of the molecules, explaining the often seen thermally induced transition $L_{\alpha} \rightarrow H_{II}$. Decreased hydration

will decrease the head group repulsion, resulting in a decreased interface area and thus in an increase of the packing parameter.

In nature and in many technical applications the lipid aggregates consist of a mixture of different lipids, which either exist in a homogenous mixture or separate into domains. As discussed in the review by Raudino (Raudino, 1995), the lateral distribution in these mixed aggregates is influenced by a number of factors like ionic strength, presence of polymers/proteins as well as the composition of the lipids and it is thus hard to give any general rules to predict when phase separation will occur.

Luzzati and coworkers determined the main features of the most commonly found mesophases in the early 1960s by X-ray diffraction (reviewed by Luzzati in 1968). Results from spectroscopy studies have increased the understanding of the dynamic nature of these phases. The lamellar phase (L_{α}) consists of stacked infinite lipid bilayers separated by water layers, while the hexagonal phases consists of infinite cylinders, having either a hydrocarbon core (H_I) or a water core (H_{II}). As shown in Fig. 5.2, the cubic phases (C) can exist in several locations in the phase diagram and have been shown to exist in a number of lipid systems (Fontell, 1990; Templer, 1998). They are isotropic and highly viscoelastic. Different structures of the cubic phases, depending on the particular lipid system, have been suggested (Luzzati et al., 1968; Larsson, 1989; Lindblom and Rilfors, 1989; Fontell, 1992; Hyde et al., 1997; Templer, 1998):

1. *Bicontinuous cubic phase* that consists of curved nonintersecting lipid bilayers, forming two unconnected continuous systems of water channels (cf., Lindblom et al., 1979; Larsson, 1989; Templer, 1998). If an interface is placed in the gap between the methyl end groups of the lipid in the bicontinuous bilayer type of cubic phase, it will form a plane that can be described as a minimal surface (Andersson et al., 1988; Larsson, 1989). This type of cubic phase, C_{bic} , has been observed in aqueous dispersions of polar lipids with low aqueous solubility like monoglycerides, phospholipids and glyceroglucolipids (Larsson, 1989; Fontell, 1990; Larsson, 1994) as well as for water soluble surfactants like ethoxylated fatty alcohols (Wallin et al., 1993).
2. *The discrete type of cubic phase* was first suggested by Luzzati et al. (1968). The occurrence of micellar cubic phase, C_{mic} , where disjointed reversed micelles embedded in a three-dimensional hydrocarbon matrix are organized in a cubic symmetry, space group Fd3m, has been reported by Luzzati and coworkers (Luzzati et al., 1992). The formation of this type of C_{mic} phases has been reported for aqueous systems containing monoolein and oleic acid (Mariani et al., 1988; Mariani et al., 1990; Luzzati et al., 1992; Borné et al., 2001), for aqueous mixtures of sodium oleate and oleic acid (Seddon et al., 1990), and consequently also during lipase catalyzed lipolysis of monoolein in aqueous dispersions under neutral /alkaline conditions (Borné et al., 2002a; Caboi et al., 2002).

Today, cubic lipid-aqueous phases are recognized as important in biological systems (Mariani et al., 1988; Larsson, 1989; Lindblom and Rilfors, 1989; Seddon, 1990; Larsson, 1994; Landh, 1995; De Kruijff, 1997; Hyde et al., 1997; Luzzati,

1997; Templer, 1998; Larsson, 2000; Larsson et al., 2002). Some of these reports suggest that cubic lipid-aqueous phases can occur during the fusion of biological membranes. There are a vast amount of studies of membrane fusion (cf., the comprehensive reviews by Kinnunen and Holopainen, 2000), which is impossible to cover here. The liquid-crystalline lipid aqueous phases can exist in excess of aqueous solution. One example of such lipid dispersions is vesicles or uni- or multilamellar vesicles,¹ which is formed from lamellar (L_{α}), phases. The stability, size and shape of vesicles can vary, depending on the composition of lipids and aqueous phase (for reviews see for instance Helfrich 1989; Lasic 1993; Komura 1996; Lasic et al. 2001). In analogy with liposomes, dispersions of a cubic lipid-aqueous phases, Cubosome^{®2} particles, which were first discovered by Larsson et al. (Larsson, 1989; Landh, 1994; Larsson, 2000) are also formed in excess of water. The stability of Cubosome[®] particles, formed in monoolein -H₂O-based systems, and the corresponding dispersed H_{II} phase (Hexosome[®] particles) in the monoolein-triolein-H₂O system were found to increase in the presence of an amphiphilic block-copolymer (polyoxamer) (Landh, 1994; Gustafsson et al., 1996; Gustafsson et al., 1997). Since the early work of Larsson et al. several studies on different types of dispersed liquid-crystalline nanoparticles have been presented with focus on systems for drug delivery as well as delivery of functionality to foods (Barauskas et al., 2005a; Barauskas et al., 2005b; Esposito et al., 2005; Spicer, 2005a; Spicer, 2005b; Almgren and Rangelov, 2006; Angelov et al., 2006; Barauskas et al., 2006a; Barauskas et al., 2006b; Boyd et al., 2006; Johnsson et al., 2006; Sagalowicz et al., 2006a; Sagalowicz et al., 2006b; Tamayo-Esquivel et al., 2006; Vandoolaeghe et al., 2006; Worle et al., 2006; Yagmur et al., 2006).

5.3 Protein/Emulsifier Interaction in Solution

5.3.1 Aqueous Soluble–Surfactant Type of Emulsifiers

The monomer concentration (defined by cmc) is an important parameter for the interaction between the emulsifier and the protein.

Ionic surfactants interact with most proteins. High surfactant concentrations will generally lead to unfolding of the protein structure. The interactions between nonionic surfactants and proteins are weaker and seldom affect the structure of proteins. Several reviews concerning the interaction between water-soluble polar lipids and protein are focused on the interaction between ionic surfactants, e.g., sodium dodecylsulphate (SDS), and globular proteins at low and intermediate temperatures

¹The term liposomes is according to IUPAC recommendation synonymous to lipid vesicles, but is sometimes used for multilamellar vesicles.

²Cubosome[®] and Hexosome[®] are registered trade names for Camurus AB, Sweden.

(Steinhardt and Reynolds, 1969; Lapanje, 1978; Makino, 1979; Jones and Brass, 1991; Ananthapadmanabhan, 1993; Dickinson, 1993; Bos et al., 1997; Dickinson, 1999). Since vast amount of the surfactant-protein work is devoted to SDS, we will use this system as an example and at the end of this section we will discuss some exceptions.

We can distinguish between two types of binding of surfactants to proteins:

1. A high affinity type of binding that occurs at low lipid concentration (Jones and Brass, 1991)
2. Nonspecific cooperative interaction taking place at higher concentrations (Jones and Brass, 1991; Ananthapadmanabhan, 1993).

An example of a binding isotherm, where the two types of binding occur, is given in Fig. 5.3. In this isotherm, for the binding of sodium dodecylsulphate (SDS) to

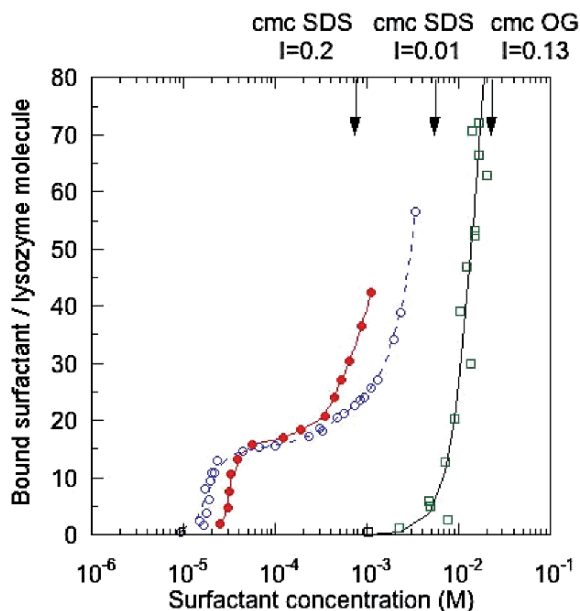

Fig. 5.3 Binding isotherms for binding of surfactants to lysozyme in aqueous solution at 25 °C. The isotherms (○, ●) for sodium dodecylsulphate (SDS) have regions of both high affinity non-cooperative binding, at low surfactant concentration, and cooperative binding at high concentration. The influence of ionic strength on the binding isotherm is shown: ●, ionic strength (I) 0.0119M and ○, ionic strength 0.2119M at pH 3.2. For comparison, an example of a binding isotherm where only nonspecific cooperative binding occurs, is also inserted. This isotherm, describing the binding of the nonionic n-octyl-β-glucoside (OG) to lysozyme (□) was measured at pH 6.4, ionic strength 0.132M. The protein concentration was 0.13% w/v. The arrows indicate cmc for the different surfactants and ionic strengths. The data is adapted from Jones (Jones and Brass, 1991) and the experimental details are given in references (Jones et al. 1984) and (Jones and Brass, 1991) for SDS and OG, respectively

lysozyme, the region of high affinity non-cooperative binding, at low surfactant concentration, is well separated from the cooperative binding observed at higher concentration. For comparison an example of a binding isotherm for the binding of a nonionic surfactant, n-octyl- β -glucoside, to the same protein, is also inserted. In this case only nonspecific cooperative binding occurs.

5.3.1.1 Specific Binding of Proteins and Emulsifiers

The specific binding is mediated by ionic and hydrophobic interactions and usually occurs below the cmc of the surfactant (Yonath et al., 1977a; Yonath et al., 1977b; Jones and Manley, 1979; Jones and Manley, 1980; Jones and Brass, 1991). There are many examples of proteins that possess binding activity, including bovine serum albumin and β -lactoglobulin. Investigation of the binding properties of these proteins has been generally confined to studies in bulk solution. For example, the presence of a fluorescent tryptophan residue in the hydrophobic cleft of β -lactoglobulin (Papiz et al., 1986) has facilitated the study of emulsifier binding by fluorescence titration. Subsequent analysis of binding by conventional methods such as that of Scatchard (Scatchard, 1949) allows determination of the dissociation constant (K_d) of the complex formed. Typical examples of K_d 's for β -lactoglobulin are shown in Table 5.1. The effect of complex formation can usually be detected by shifts in the surface-tension (γ) curve (Dickinson and Woskett, 1989). An example of this is shown for Tween 20 and β -lactoglobulin in Fig. 5.4 (Coke et al., 1990). Surface-tension/concentration (γ -c) curves for Tween 20 alone and in the presence of a fixed concentration of β -lactoglobulin (0.2 mg/ml; 10.9 μ M) are shown.

The general features described earlier are evident with a comparatively low concentration of protein causing a significant reduction in γ . In the absence of protein, γ reduces gradually with increasing Tween 20 concentration. The gradient of the reduction in surface tension reduces at higher Tween 20 concentrations (>30 μ M) but

Table 5.1 Typical dissociation constants of emulsifier/ β -lactoglobulin complexes

Emulsifier	Dissociation constant	References
Tween 20	4.6 μ M	Wilde and Clark, 1993
L- α lysophosphatidylcholine, palmitoyl	166 μ M	Sarker et al., 1995
Sucrose monolaurate	11.6 μ M	Clark et al., 1992
Sucrose monostearate	1.02 μ M	Clark et al., 1992
Sucrose monooleate	24.8 μ M	Clark et al., 1992
Sodium stearoyl lactylate, pH 7.0	0.26 μ M	Clark, unpublished
Sodium stearoyl lactylate, pH 5.0	0.30 μ M	Clark, unpublished
Lauric acid	0.7 μ M	Frapin et al., 1993
Palmitic acid	0.1 μ M	Frapin et al., 1993

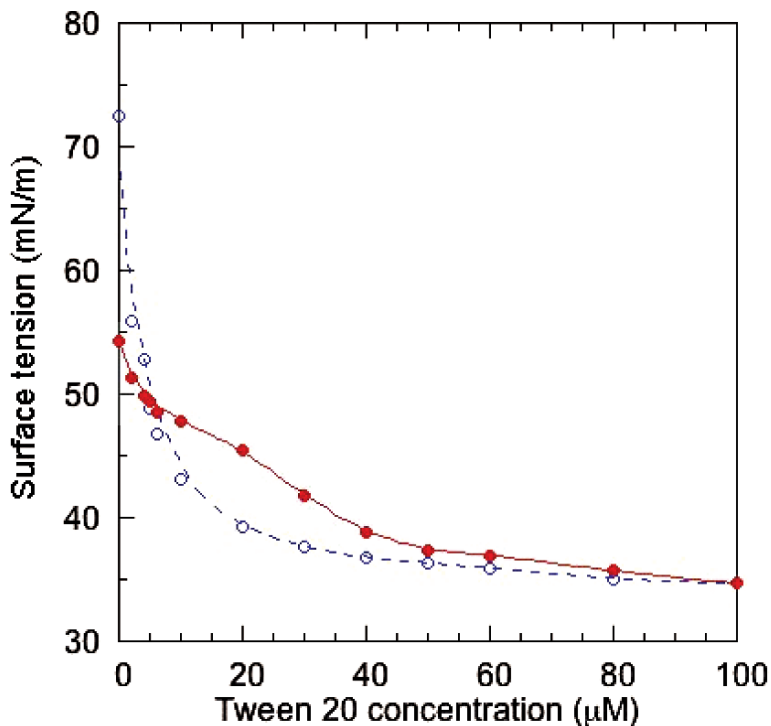
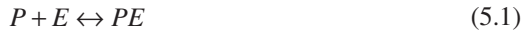

Fig. 5.4 Surface tension isotherm for Tween 20 in the absence (●) and presence (□) of 0.2 mg/mL β -lactoglobulin. The data were recorded after 20 min adsorption and are therefore not at equilibrium

doesn't become completely flat due to failure to attain equilibrium γ , possibly due to the presence of a mixture of surface-active species in the Tween 20 sample. In contrast, the curve in the presence of protein maintains a relatively steady surface-tension value of about 50 mN/m up to Tween 20 concentrations of 25 μ M due to the surface tension reduction caused by adsorption of the protein. This means that the curve for the sample containing protein crosses that of Tween 20 alone. This is strong evidence for complex formation between the two components, since the curves cross due to a reduction in the concentration of free emulsifier in solution as a fraction of the emulsifier interacts with the protein to form the complex.

Thus, great care must be taken when considering the surface properties of compounds in solutions containing mixtures of interacting components. In the simplest case of a single binding site, the two-component system becomes a three-component system comprising free emulsifier, free protein, and emulsifier/protein complex. The relative proportions of the components present can be calculated in the following manner (Clark et al., 1992). In the simplest case, the interaction of an emulsifier (E) with a protein (P) can be described by the expression



where PE is the emulsifier/protein complex. Thus the dissociation constant (K_d) for the complex can be expressed as

$$K_d = \frac{[P][E]}{[PE]} \quad (5.2)$$

where the square brackets indicate molar concentrations of the different species. It is also the case that

$$[P] = [P_{\text{tot}}] - [PE] \quad (5.3)$$

$$[E] = [E_{\text{tot}}] - [PE] \quad (5.4)$$

where $[P_{\text{tot}}]$ and $[E_{\text{tot}}]$ are the total protein and emulsifier in the system. Substituting Eqs. (5.3) and (5.4) in Eq. (5.2) gives

$$[PE] - ([E_{\text{tot}}] + [P_{\text{tot}}] + K_d)[PE] + [P_{\text{tot}}][E_{\text{tot}}] = 0 \quad (5.5)$$

which can be solved for [PE] and can be used to calculate the relative concentrations of the three components. In addition, the binding data, which may comprise a change in a parameter (e.g., intrinsic fluorescence) caused by formation of the complex may be fitted using this equation, provided there is a single active binding site and the titration is carried out to saturation. Alternatively, it is possible to determine the dissociation constant and number of binding sites from the Scatchard equation (Scatchard, 1949)

$$\frac{v}{[E]} = \frac{n - v}{K_d} \quad (5.6)$$

where v is the fraction of protein with occupied sites (i.e., $[PE]/[P_{\text{tot}}]$). If the Scatchard plot of v against $v/[E]$ gives a straight line, it indicates the presence of only one class of binding sites. The gradient of this line is $1/K_d$, and the intercept on the x axis gives the number of binding sites, n . If the Scatchard plot does not give a straight line, then the shape of the curve obtained can be used to identify if the observed binding is positively or negatively cooperative or the presence of multiple independent sites. In the former case the Hill equation can be used to determine the K_d and a cooperativity coefficient (Hill, 1910).

5.3.1.2 Nonspecific Interaction

The nonspecific interaction often occurs close to the cmc as it is associated with the aggregation of the surfactant and usually leads to a destabilization of the native conformation. The cmc of the surfactant is thus an important parameter and conditions that affect cmc will generally affect the binding, (cf., Ananthapadmanabhan, 1993; Waninge et al., 1998). The saturation of all the binding sites generally corresponds to 1–2 g of surfactant per gram of protein (Reynolds and Tanford, 1970; Jones and Brass, 1991; Ananthapadmanabhan, 1993).

The extent of interaction and unfolding depend mainly on the nature of the surfactant hydrophilic group, surfactant chain length, ionic strength, pH, temperature and organic additives as well as on the protein itself (Ananthapadmanabhan, 1993). Organic additives include the presence of impurities in proteins as well as in the lipids. For instance, it has been demonstrated by Lunkenheimer and coworkers that commercial SDS samples usually contains a substantial amount of dodecanol, which actually is more surface active than SDS by itself (Miller and Lunkenheimer, 1986; Lunkenheimer and Miller, 1987; Lunkenheimer and Czichocki, 1993). Similarly, it has been shown by Clark et al. that β -lactoglobulin contains bound fatty acids, which may alter the binding of other surface active compounds (Clark et al., 1995). Clearly, the presence of amphiphilic impurities may give anomalous effects on the binding of other surfactants.

The effect of surfactant protein interaction on the structural stability of proteins depends strongly on the mode of interaction. In fact as shown in Fig. 5.5, the same surfactant can act as both stabilizing and destabilizing depending on surfactant concentration as well as other solution conditions. At low surfactant-to-protein ratios, high affinity interaction between certain proteins and surfactants occur. This interaction stabilizes the protein structure against thermally induced unfolding, thus the thermally induced transition is shifted towards higher temperature as illustrated in Fig. 5.5 and previously reported by Hegg (Hegg, 1980) for SDS and β -lactoglobulin. Similar findings has also been reported for other protein–surfactant complexes such as between fatty acids or SDS and bovine serum albumin (Gumpen et al., 1979) as well as between palmitic acid and β -lactoglobulin (Puyol et al., 1994). As discussed above increasing the free surfactant concentration to the cmc give rise to nonspecific cooperative binding, which in turn can lead to unfolding of the protein as illustrated in Fig. 5.5 (Waninge et al., 1998). This is in agreement with earlier reports, where total surfactant ratio above 10 moles of SDS per mole of serum albumin or 1 mole of SDS per mole of β -lactoglobulin monomer were observed to cause unfolding of the protein (Gumpen et al., 1979; Hegg, 1980).

Anionic

Surfactants like alkylsulphates or alkylethersulphates interacting with proteins with opposite net charge, e.g., lysozyme or gelatine, might cause precipitation of the protein–surfactant complex due to neutralization of the net charge (Jones and Manley,

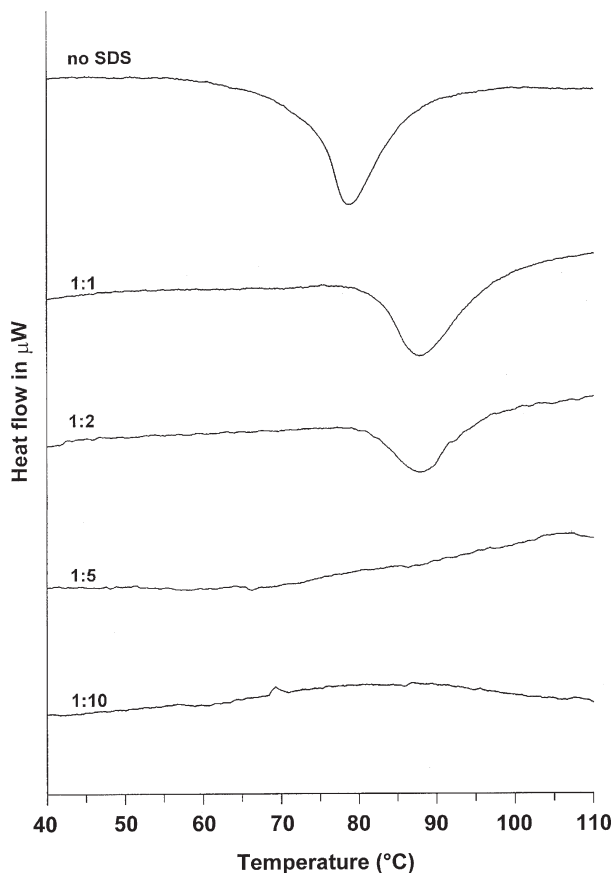

Fig. 5.5 The thermograms from top to bottom shows the thermally induced unfolding of β -lactoglobulin (1.4 mM in 60-mM NaCl, pH 6) when increasing the protein/SDS molar ratio. The cmc of SDS is 0.47 mM at 25 °C and ≈ 1 mM at 90 °C, when taking into account the ionic strength of the protein solution. Assuming that 1 SDS molecule is bound per β -lactoglobulin monomer, 3-mM SDS has to be added to reach the cmc of the surfactant at 90 °C. The data are adapted from (Waninge et al. 1998), where also the experimental details are given

1979; Fukushima et al., 1981; Fukushima et al., 1982; Chen and Dickinson, 1995a; Chen and Dickinson, 1995b; Morén and Khan, 1995; Stenstam et al., 2001). Although the protein is precipitated, usually only small changes in the secondary structure occur. At an increased surfactant concentration the complex is dissolved and the protein starts to be unfolded. Generally, denaturation of proteins by long-chain alkyl sulphates such as SDS results in a structure with large fractions of the polypeptide chain in an α -helical conformation (Jirgensons, 1976; Mattice et al., 1976; Tanford, 1980). As a simple rule, proteins with a low content of α -helix in

their native form, such as concanavalin A, β -lactoglobulin and ovalbumin, will increase in α -helix content upon interacting with SDS. The reverse is observed for proteins with a high α -helix content in their native form, e.g., myoglobin and serum albumin (Mattice et al., 1976). The structure resulting from the interaction is thought to consist of helical segments with flexible joints, and with most of the hydrophobic side-chains exposed to the surfactant. The successive binding of SDS opens up the molecules, due to the increased electrostatic repulsion, and unveils new hydrophobic domains, which can bind additional surfactants. This association stabilizes α -helical folding at the expense of nonrepetitive structure. The free energy gained by this process in most cases by far exceeds the unfavorable free energy change of disrupting the native conformation (Tanford, 1980). Light scattering studies confirm the expansion of the hydrodynamic radius of the protein upon interaction with SDS (Tanner et al., 1982). Several models of the structure of complexes between SDS and proteins at high surfactant concentration, like the correlated necklace, rod-like structure and flexible helix, have been considered, (cf., Guo and Chen, 1990; Ananthapadmanabhan, 1993). However, small-angle neutron scattering data strongly indicates a structure resembling a necklace (Guo and Chen, 1990; Guo et al., 1990), where the polypeptide chain with high flexibility is decorated with SDS micelles (Mattice et al., 1976; Guo and Chen, 1990) as shown in Fig. 5.6. This interaction is reported to take place via the monomeric form of the surfactant (Mattice et al., 1976; Ananthapadmanabhan, 1993).

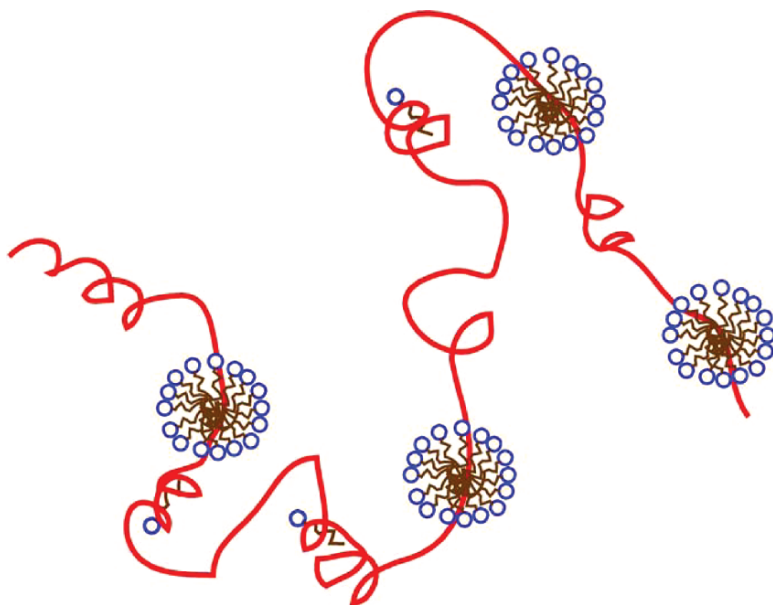

Fig. 5.6 Schematic representation of the so-called necklace model for the interaction between SDS and proteins. The solid line represents the unfolded polypeptide chain, which still contains secondary structure. Micelle-like clusters are cooperatively formed on the polypeptide chain

It should also be born in mind that not all proteins are fully unfolded by SDS. For instance it has been shown that the activities of glucose oxidase, papain, pepsin and bacterial catalase were not affected by high concentration of SDS, correlated to the low binding of SDS (Nelson, 1971; Jones et al., 1982).

Within the type of surfactant the binding is dependent on the nature of the polar head group, e.g., for anionic surfactant the interaction decreases in the order alkyl sulphates > alkyl sulphonates > alkyl benzene sulphonates > carboxylates \approx alcohols (Reynolds et al., 1968; Rendall, 1976).

Nonionic

The interaction between nonionic surfactants and proteins are generally weak (Reynolds et al., 1968; Green, 1971; Makino et al., 1973; Sukow et al., 1980; Cordoba et al., 1988; Bos et al., 1997). They are therefore often used to solubilize/stabilize proteins in biochemical preparations, e.g. (Ahlers et al., 1990). For instance, each β -lactoglobulin monomer binds only one Tween 20 (Wilde and Clark, 1993), or one sucrose ester (Clark et al., 1992) or one Triton X-100 (Green, 1971). Generally, minor changes of the structure upon interaction are observed (Makino et al., 1973; Cordoba et al., 1988). An unordered, flexible protein, β -casein, was found to bind less than one sucrose ester per protein molecule, possible due to incorporation of the surfactant in β -casein micelles (Clark et al., 1992). The specific ionic interaction present for ionic surfactants in addition to the hydrophobic interaction that leads to more severe effects on the protein structure, is absent for the nonionic surfactants (Fig. 5.3). Another reason for the weaker interaction between proteins and nonionic surfactants has been assigned to the lower cmc, which gives fewer monomers in the solution that can bind to the protein (Makino et al., 1973). The cmc is increased when the chain length is decreased, which may change this situation; the binding of octyl glucoside to various proteins was found to occur in a cooperative manner at surfactant/protein molar ratio of hundred and more, without any evidence of protein denaturation (Cordoba et al., 1988).

Also the nature of the nonionic polar head groups will affect the interaction. For a series of Triton X surfactants increasing the hydrophilic oxyethylene chain length was found to decrease the strength of interaction with BSA, due to steric hindrance as well as relatively lower hydrophobicity (Sukow et al., 1980). The calorimetric data indicated that some conformational changes of BSA occurred during the saturation of the low affinity, non-cooperative binding sites (Sukow et al., 1980).

Some studies have also been carried out with the zwitterionic surfactant lysophosphatidylcholine (LPC), which was found to bind cooperatively to puuroindoline, a lipid binding protein isolated from wheat flour, at a molar ration of 5 to 1 (Wilde et al., 1993), with an affinity that was dependent on the chain length of the LPC molecule (Husband et al., 1995). One LPC molecule was also found to bind with less affinity to β -lactoglobulin than Tween 20 (Sarker et al., 1995). The binding of Tween 20, as opposed to LPC, had a much more disruptive effect on the interfacial film of the protein, attributed to the bulkier head group of Tween 20. This implies that a

nonionic surfactant can also disrupt the structure of a protein, provided that the binding is strong enough and the hydrophilic head group large enough to sterically induce conformational changes.

Cationic

Cationic surfactants generally seem to exhibit an intermediate action on water-soluble proteins. Reports in the literature indicate a cooperative interaction with proteins, but with less affinity and thus with less perturbation of the folded state, compared to the effect of the anionic ones (Tanford and Epstein, 1954; Kaneshina et al., 1973; Nozaki et al., 1974; Ericsson et al., 1987a; Ericsson et al., 1987b; Waninge et al., 1998). If the binding is governed both by electrostatic and hydrophobic interactions, anionic and cationic surfactants will obviously occupy different sites. Nozaki et al. has suggested that the lower affinity of many proteins for cationic compared to anionic surfactants, can be explained by the fact that the cationic arginine and lysine side chains contributes with more CH_2 groups than anionic aspartate and glutamate side chains (Nozaki et al., 1974). This implies that the combined electrostatic and hydrophobic interactions and possibly accessibility of the charged groups will be more favorable for anionic surfactants. As a consequence, the cooperative binding step will start at a higher concentration for cationic relative to anionic surfactants (Ananthpadmanabhan, 1993).

5.3.1.3 Effect of Solution Conditions

Increased ionic strength can affect the interaction between protein and ionic surfactants by reducing the electrostatic attraction between surfactants and amino acid residues with opposite net charges. Generally, the high affinity non-cooperative binding is strongly influenced by the electrostatic interaction between surfactant and protein. Thus this part of the binding isotherm will be shifted towards higher surfactant concentration upon addition of salt, as observed for lysozyme and SDS (Fig. 5.3) (Jones et al., 1984; Jones and Brass, 1991). Increasing the ionic strength, will on the other hand, favor the cooperative binding by screening the repulsion between the charged surfactant head groups. This part of the surfactant binding isotherm will therefore be shifted towards lower surfactant concentrations, parallel to the decrease of surfactant cmc. Here it is important to point out that the presence of highly charged proteins will affect the formation of micelles in the same way as a polyelectrolyte as well as the effect of temperature. This has been amply demonstrated by Waninge et al. who studied thermally induced unfolding of β -lactoglobulin at a concentration of 1.4 mM in 60-mM NaCl, pH 6, at various molar ratios of SDS and their main findings are illustrated by the thermograms, obtained by differential scanning calorimetry (DSC), in Fig. 5.5 (Waninge et al., 1998). From this figure we note that the peak corresponding to the thermal unfolding disappears when the protein/SDS molar ratio increases above 1:2. This corresponds to a SDS concentration of about

3 mM. The cmc for SDS is about 8.1–8.2 mM in water (Williams et al., 1955; Flockhart, 1961). However, the cmc for ionic surfactants decreases with ionic strength and increases with temperature (Williams et al., 1955; Flockhart, 1961; Evans et al., 1984a; Evans et al., 1984b). Taking these effects into account, the presence of β -lactoglobulin (which has a net charge of -5 at pH 7) at a concentration of 1.4 mM in 60-mM NaCl, the cmc of SDS is expected to be 0.47 mM at 25 °C and ≈ 1 mM at 90 °C. When taking into account the specific binding of one SDS molecule per β -lactoglobulin monomer, 3-mM SDS has to be added to reach the cmc of the SDS at 90 °C. Thus any effect of nonspecific cooperative interaction between the surfactant and the protein is expected to take place at this SDS concentration. In Fig. 5.5 we observe an apparent loss of protein structure. The unfolding of the protein structure at low temperature, which is observed in the presence of most anionic surfactants such as SDS at high concentration, is expected to be maintained at increased temperature. However, since cmc generally increases with temperature, we might arrive at the situation where the cooperative binding ceases to exist at the high temperature, maybe even below the temperature at which thermally induced unfolding takes place. Interestingly, Waninge et al. observed that the conformational changes invoked by the nonspecific cooperative binding of SDS at 25 °C could be reversed by extensive dialysis (Waninge et al., 1998).

Although cationic surfactants seem to cause less unfolding of globular proteins at low temperature than anionic, some reports indicate that they can destabilize globular proteins at increased temperature (Ericsson et al., 1983a; Ericsson et al., 1987a). However, these reports also indicate that the unfolding process at the same time becomes considerably more reversible. The heat denaturation of ovalbumin, which in practice is completely irreversible, was found to be completely reversible in the presence of high concentrations of cationic surfactants (Ericsson et al., 1983a). This was explained by decreased inter- and intramolecular interactions at high temperature, due to interaction between the unfolded protein and surfactant, which facilitates the re-formation of the native complex on cooling.

As a rule of thumb, an increase in pH will shift the binding of anionic surfactants to higher concentrations (Reynolds et al., 1970). In this case one would expect that both the specific and the cooperative binding are affected in the same way. A decrease of pH will have the same effect on binding of cationic surfactants (Subramanian et al., 1984). At low surfactant concentrations, that is, well below cmc, cationic amphiphiles increase the solubility of proteins on the acidic side of the isoelectric point (pI), while precipitation can occur on the alkaline side of pI. Anionic amphiphiles will affect solubility in the opposite direction. The solubilizing effect is also observed at high temperatures.

We conclude that since the binding generally is thought to occur via monomers, any change affecting the cmc will also affect the cooperative binding at concentrations close to and above cmc. Under some conditions the formation of surfactant micelles will be energetically favored compared to binding to the protein. If cmc is of the same order of magnitude as the concentration necessary for binding to occur, the lowering of cmc caused by increasing ionic strength might even prevent binding.

5.3.2 Phase Behavior of Emulsifier Protein Systems

So far we have mainly addressed the interaction at low protein concentrations. Morén and Khan (Morén and Khan, 1995) investigated the phase behavior of the anionic SDS, positively charged lysozyme and water over a wide concentration range and one of the phase diagrams they determined is given in Fig. 5.7a. Stenstam et al. later investigated in detail the stoichiometry of the formed complex and their findings are summarized in Fig. 5.7b (Stenstam et al., 2001). Small amounts of SDS, at a ratio to lysozyme corresponding to charge neutralization of the protein, were found to give precipitation. A net attractive force exists between the surfactant–protein complexes and hydrophobic interactions dominate (Fig. 5.7b). Further addition of SDS dissolved the precipitate and complete dissolution was achieved when the number of SDS molecules was equal to the number of (18) positive charges on the protein. A bluish gel phase occurred when the protein concentration was between 7–20% (w/w). A further increase of the ratio between SDS and lysozyme, leads to a strong net repulsive electrostatic interaction between the surfactant–protein complexes (Fig. 5.7b). Consequently an isotropic solution is formed. Morén and Khan also investigated the effect of varying alkyl chain length, $C_{12}SO_4$, $C_{10}SO_4$, C_8SO_4 , and C_6SO_4 on the lysozyme–sodium alkyl sulfate–water ternary systems (Morén and Khan, 1998). The extension of the solution region decreased with increasing surfactant chain length and the surfactant with shortest hydrophobic tail (C_6SO_4) forms the largest solution region with lysozyme without precipitation. The extension of the precipitation region toward higher surfactant concentrations increases with decreasing

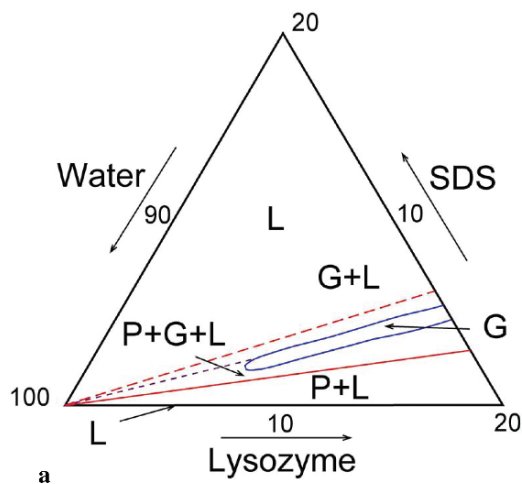

Fig. 5.7a Phase diagram of the lysozyme–SDS–water ternary system, where L indicates solution, G gel and P precipitate. The figure is adapted from (Morén and Khan, 1995), where experimental details are given

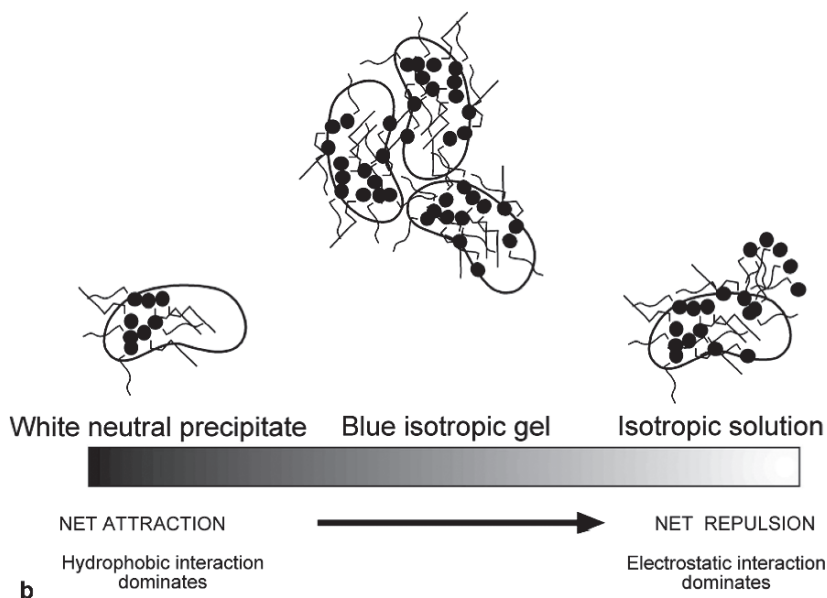

Fig. 5.7b Schematic representation of the interaction between protein surfactant complexes in the lysozyme–SDS–water system. Figure adapted from Stenstam et al. (2001), where the experimental details are given

surfactant chain length. The surfactant concentration required to redissolve the precipitate at dilute protein concentrations therefore seems to follow the cmc for the surfactant in water, which also increases with decreasing surfactant chain length. A single gel phase was only observed for the $C_{12}SO_4$ and $C_{10}SO_4$ systems and not in presence of C_8SO_4 and C_6SO_4 . Similar types of gel phases are expected to occur in more food relevant surfactant/lipid and protein aqueous mixtures and therefore offer interesting possibilities to vary the functional properties of foods and food ingredients.

5.3.3 Emulsifiers with Low Aqueous Solubility

For emulsifiers with low aqueous solubility the emulsifier self-assembly structure and its properties control the interaction with proteins

In this section we will discuss interactions involving lipids with low solubility where the lipids exist as dispersed particles, liposomes or vesicles, liquid crystalline phases as well as monolayers at interfaces. Many of the principles discussed in the earlier sections, also do apply for protein–lipid interactions in condensed systems.

Polar lipids, which normally are water-insoluble, associate into a variety of structures in aqueous solution. This process will have an impact on interactions with proteins. For lipids with low aqueous solubility the interaction with the proteins mainly involves the self-assembled structure formed by the lipids. However, we note that even polar lipids that are considered water-insoluble have a certain monomer solubility, which although small (about 10^{-7} for monoolein and about 10^{-10} – 10^{-12} M for phospholipids) makes it possible for them to interact with proteins in the monomeric form, in particular if the protein has a high affinity binding-site for the lipids. This is demonstrated in Fig. 5.8, which shows the thermograms from differential scanning calorimetry measurements of β -lactoglobulin, distearoylphosphatidic acid (DSPA) and β -lactoglobulin + an aqueous dispersion of DSPA, respectively. The peak corresponding to the thermally induced unfolding transition of β -lactoglobulin in presence of DSPA is shifted towards higher temperature compared to the one recorded for the pure protein. This confirms the presence of a specific interaction between phosphatidic acid and β -lactoglobulin that thermally stabilizes the protein. This was also observed in the presence of dipalmitoylphosphatidic acid (DPPA), but no such interaction was observed when the protein was mixed with phosphatidylcholine, phosphatidylethanolamine or phosphatidylglycerol (Kristensen et al., 1997). Neither could any interaction be observed if the lipid contained unsaturated fatty acid residues. Thus the results show that the interactions between β -lactoglobulin

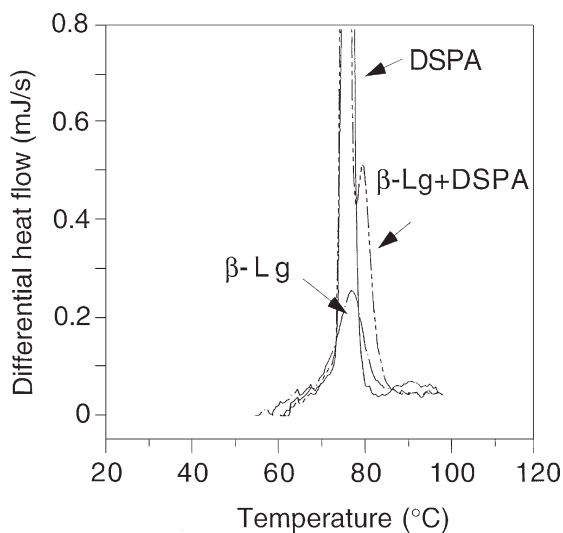

Fig. 5.8 The interaction between distearoylphosphatidic acid (DSPA) and β -lactoglobulin (β -Lg) is demonstrated by the results from differential scanning calorimetry (DSC) where the thermogram of the protein/lipid mixture is compared with those of the pure components. The thermograms of DSPA, 5% (w/v) (—), β -Lg 5% (w/v) (---) and a mixture of β -Lg 5% and DSPA 5% (w/v) (- · -) in 1% sodium chloride at pH 7. A scanning rate of 10 °C/min was used. Data adapted from Kristensen et al. (1997), where also the experimental details are given

and phospholipids are strongly dependent on the acyl chain as well as the head group. A small negatively charged head group is needed for the interaction to take place. Such an interaction can have important implications for the functional properties of the protein. We discussed above that fatty acids bound to β -lactoglobulin could affect the interfacial behavior of the protein (Clark et al., 1995). Kurihara and Katsuragi reported that a lipid-protein complex, formed between β -lactoglobulin and phosphatidic acid, could mask bitter taste (Kurihara and Katsuragi, 1993). This property was suggested to be specific for phosphatidic acid as no effect was observed for mixtures of β -lactoglobulin and phosphatidylcholine, triacylglycerol or diacylglycerol.

Even if no specific interaction occurs, proteins can have an impact on liquid crystalline phase or gel phase due to the limited space of the aqueous cavity. This was demonstrated by Minami et al, who investigated the incorporation of lysozyme, β -lactoglobulin and α -lactalbumin in a sphingomyelin gelphase containing 0.6 wt% sodium palmitate and 80 wt% aqueous solution (Minami et al., 1996). The dimension of the aqueous layer in the gel phase was suggested to limit the amount of protein that could be incorporated. Above this limit, phase separation will occur with a gel phase and an "outside" protein rich solution. The protein will, at high enough concentration, probably also compete for the water in the interlamellar spacing, which eventually leads to a reduction of the aqueous layer thickness. This effect was demonstrated for high molecular weight polymers in equilibrium with the phosphatidylcholine lamellar phase (LeNeveu et al., 1977). The polymer was unable to enter the aqueous layer, but still exerted an osmotic stress that was large enough to compress the lamellar lattice as shown by x-ray diffraction data. This method has been used to measure the interaction between the lipid bilayers (LeNeveu et al., 1977; Cowley et al., 1978).

Proteins are of course also able to enter into the aqueous layer of a lamellar phase and thereby affect the swelling. This was shown by Rand (Rand, 1971), who studied the penetration of bovine serum between negatively charged lecithin-cardiolipin mixed bilayers in a lamellar phase at pH 3.3, where the protein has a positive net charge. BSA is also likely to adopt a more expanded structure at this pH, thus exposing more hydrophobic segments. He found that the inter-lamellar spacing of the lamellar phase, decreased with decreasing cardiolipin/bovine serum albumin ratio. This was related to a reduction of the negative charge of the lipid layer as the amount of bound protein increases.

We will start our discussion by giving some example of the interplay between the lipid structures and protein in terms of the effect on the curvature of the lipid-aqueous interface, since curvature place an important role in condensed matter as discussed in the book by Hyde et al. (Hyde et al., 1997).

5.3.3.1 Protein Interactions that Increase the Curvature of the Lipid-Aqueous Interfaces

Proteins or peptides that penetrate into the hydrophobic domain of a lipid bilayer generally provokes an increase of curvature of the lipid-aqueous interface, i.e., becomes

more concave towards the aqueous space. Quite a few of the membrane bound peptides have these properties, such as Gramicidin A, a hydrophobic polypeptide, which forms channels for monovalent cations in phospholipid membranes (Wallis, 1986). This peptide was found to favor the transition between lamellar phase \rightarrow reversed hexagonal (H_{II}) phase in dioleoylphosphatidylcholine (DOPC) and dioleoylphosphatidylethanolamine (DOPE) systems in an excess of water, as observed by NMR-studies (Chupin et al., 1987).

Not only proteins or peptides that penetrate into the lipid bilayer can induce phase transitions, but also proteins that mainly interact with the headgroups of the phospholipid bilayer can give rise to similar effects. This has been demonstrated for cytochrome c, which has a positive net charge and has been shown to interact with negatively charged phospholipids (De Kruijff and Cullis, 1980). The binding of cytochrome c to anionic cardiolipin liposomes induced the formation to an inverted hexagonal, H_{II} , structure (De Kruijff and Cullis, 1980). No interaction and hence no phase transition was observed in the presence of liposomes composed of neutral zwitterionic lipids like PC and PE. A phase transition to the H_{II} -phase was observed, if a sufficient fraction of these lipids was replaced for cardiolipin. Interestingly, the protein was found to interact with liposomes of the anionic lipid phosphatidylserine (PS), but did not induce any phase transition. The interaction between cardiolipin and cytochrome c was also studied by Spooner and Watts, using deuterium and phosphorus 31 NMR measurements (Spooner and Watts 1991b). They likewise found that the interaction can, depending on the lipid stoichiometry, cause a transition from a lamellar to a nonbilayer structure. The binding of the protein with the liquid-crystalline bilayers of cardiolipin was also found to cause extensive rearrangement of the cytochrome c secondary structure (Spooner and Watts, 1991b; Spooner and Watts, 1991a).

Studies of the interaction between cytochrome c and suspensions of DMPG or admixtures of dioleoylglycerol (DOG) or DOPC with DOPG also showed that binding of cytochrome c could promote an increase in surface curvature of the lipid aggregates from a bilayer structure (Heimburg et al., 1991). This is deduced from NMR-data where an isotropic peak occurs in the presence of cytochrome c, indicating cubic lipid phases, small spherical vesicles or extended bilayers with high local curvature. The structure of cytochrome c was found to change on binding to the lipid, and two forms, depending on the lipid composition, were identified with resonance Raman measurements:

- I. close to the native conformation in solution
- II. unfolded with the heme crevice opened

The changes in protein structure could be correlated with the curvature of the lipid bilayer as illustrated in Fig. 5.9 as the ratio between the unfolded (II) and native (I) cytochrome c (cyt c) in DOPC/DOG dispersions versus DOG mol %. The presence of DOG was found to induce spontaneous curvature in the DOPG lipid bilayer in the pure lipid system, which at DOG content of $\approx 50\%$ leads to the transition to a reversed hexagonal (H_{II}) phase. In the absence of DOG, that is a strict bilayer structure, the binding of the more unfolded form (II) of cytochrome is favored, whereas the fraction of the more native globular protein structure (I) increases with the

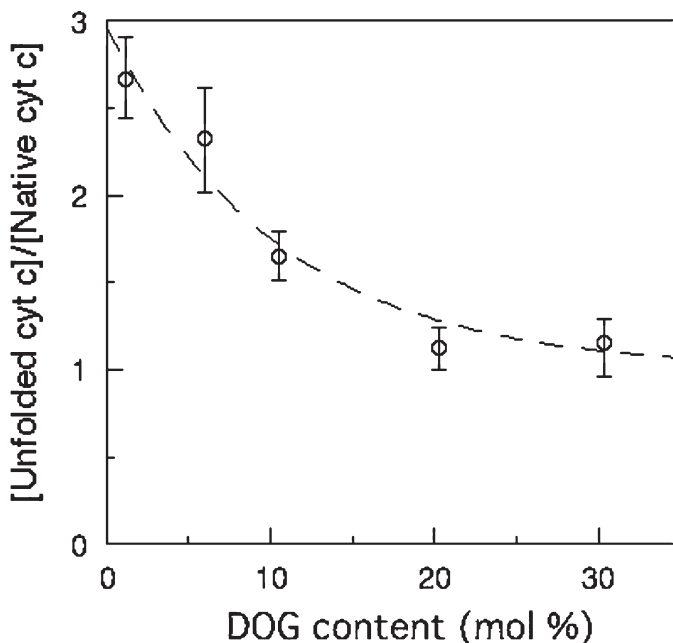

Fig. 5.9 Concentration of unfolded (II) and native (I) cytochrome *c* (cyt *c*) in dioleoylphosphatidylcholine (DOPC)/dioleoylglycerol (DOG) dispersions versus DOG mol% determined from Raman resonance spectra. The concentrations of lipid and cytochrome *c* were 300 and 20 μM , respectively, in an aqueous buffer (1-mM HEPES, 1-mM EDTA) of pH 7.5. Data adapted from Heimburg et al. (1991), where also the experimental details are given

amount of DOG (Fig. 5.9) and thus with curvature of the surface. The physical state of the lipid was also found to affect the proportions of the two structural forms of cytochrome *c*. In the fluid state of pure DMPG, the fraction of the more unfolded form (II) was larger (85%) than when the lipid was in the gel state (80%). It is noteworthy that they found that the bound fraction of the more unfolded form (II) to the fluid DOPG bilayer structure was substantially lower (75%), indicating that not only the fluidity of the bilayer matters, but also the type of lipid.

The interaction between cytochrome *c* and monoolein in the cubic phase was studied by Razumas et al. by differential scanning calorimetry (DSC) and optical microscopy (Razumas et al., 1996a). In line with the studies reported above they also found that the presence of cytochrome *c* at high enough concentrations favored lipid aggregates with a larger curvature. Thus they observed that the phase transitions cubic $\rightarrow H_{II} \rightarrow L_2$ in the monoolein-cytochrome *c*-water system took place at a lower temperature than in the binary monoolein-water system (Razumas et al., 1996a). Similar effects were observed when glucose oxidase was included into monoolein-aqueous cubic phase (Barauskas et al., 2000). The temperature of the phase transition cubic $\rightarrow H_{II}$ in the monoolein-glucose oxidase aqueous system decreased with increasing glucose oxidase concentration.

5.3.3.2 Protein Interactions that Decrease the Curvature of the Lipid-Aqueous Interfaces

McCallum and Epand found that changing the curvature of biological membranes could modify membrane bound insulin receptor autophosphorylation and signaling (McCallum and Epand, 1995). This was demonstrated by adding compounds that raised the bilayer to reverse hexagonal (H_{II}) transition temperature of model membranes, that is decrease the curvature of the membrane. This inhibited the insulin stimulation of the receptor phosphorylation.

Fraser et al. investigated the ability of a range of basic proteins and polylysine to convert a reversed hexagonal (H_{II}) phase, consisting of dioleoylphosphatidylethanolamine (DOPE) and mixtures of DOPE and phosphatidylserine (PS), to stable lamellar (L_{α}) phases at pH 9 where DOPE is anionic and at pH 7 when it is zwitterionic (Fraser et al., 1989). The proteins investigated were all capable of binding to the H_{II} -phase at pH 9, but only myelin basic protein and polylysine did induce transition to the L_{α} -phase. Lysozyme formed a new H_{II} -phase where the protein was included. A lowering of the pH seemed to release the proteins, except for mellittin, which also seemed to penetrate into the hydrophobic core of the lipid aggregates. The presence of PS in the H_{II} -phase at pH 7 increased the protein binding, but only interaction with myelin basic protein gave a lamellar phase. Based on earlier studies, Fraser et al. suggested that the myelin basic protein stabilized the lamellar phase by interacting with the DOPE head-group and thereby increasing its effective size (Fraser et al., 1989). They concluded that the properties of myelin basic protein in terms of stabilizing the lamellar structure could be related to the role of the protein to stabilize the myelin sheath multilayers.

5.4 Interaction between Protein and Surfactants or Polar Lipids at Interfaces

Defining different plausible scenarios and principles and defining simple models

Interactions between proteins and surfactants at air/water and oil/water interfaces has attracted considerable study in recent years because the consequences of competitive adsorption of these two species at these interfaces can often strongly influence dispersion (foam or emulsion) stability against coalescence. The majority of proteins have high affinity for interfaces, which they saturate at comparatively low concentrations compared to low molecular weight (LMW) surfactants (Dickinson and Woskett, 1989; Coke et al., 1990). Thus, on a mole for mole basis at low concentrations, proteins reduce the surface tension to a greater extent than LMW surfactants. However, the opposite effect is observed at high concentrations, because at saturation coverage with LMW surfactants, the interfacial tension of the interface is usually lower than that achieved by proteins, and as a result, the latter molecules will be displaced from the interface. The region where the two different components coexist in the interfacial layer is of greatest interest, since it is in this region that will mostly affect the stability of the system towards coalescence.

The mechanisms by which proteins, polar lipids or mixtures of them stabilize emulsions and foams can be quite different. Generally, polar lipids are capable of reducing the interfacial tension more than proteins, while the protein molecules can be anchored at multiple sites at the interface. In principle thin films are stabilized by two distinct mechanisms; the one that dominates is dependent upon the molecular composition at the interface (Clark, 1995). Low molecular weight surfactants such as food emulsifiers or polar lipids congregate at the interface and form a fluid-adsorbed layer at temperatures above their transition temperature (see Fig. 5.10). When a surfactant-stabilized thin film is stretched, local thinning can occur in the thin film. This is accompanied by the generation of a surface-tension gradient across the locally thin region. Surface tension is highest at the thinnest point of the stretched film, due to the local decrease in the surface concentration of emulsifier in the region of the stretch. Equilibrium surface tension is restored by adsorption of surfactant from the interlamellar liquid, which is of very limited volume in a drained thin film. This process is called the “Gibbs effect.” Alternatively, migration of the surfactant by lateral diffusion in the adsorbed layer toward the region of highest surface tension may also occur (Clark et al., 1990b). Here, the surfactant drags interlamellar liquid associated with the surfactant head group into the thin region of the film and contributes to the restoration of equilibrium film thickness. This process is often referred to as the “Marangoni effect” (Ewers and Sutherland, 1952).

In contrast, the adsorbed layer in protein-stabilized thin films is much stiffer and often has viscoelastic properties (Castle et al., 1987). These derive from the protein/protein interactions that form in the adsorbed layer (see Fig. 5.10b). These interactions result in the formation of a gel-like adsorbed layer, referred to as a “protein-skin” (Prins, 1999), in which lateral diffusion of molecules in the adsorbed layer is inhibited (Clark et al., 1990a). Multilayer formation can also occur and serves to further mechanically strengthen the adsorbed layer (Coke et al., 1990). When pure protein films are stretched, the change in interfacial area is dissipated across the film, due to the cohesive nature of the adsorbed protein layer and possibly the deformability of the adsorbed protein molecules.

Thin-film instability can result in systems that contain mixtures of proteins and low molecular weight surfactants (Coke et al., 1990; Clark et al., 1991b; Sarker et al., 1995), as is the case in many foods. The origin of this instability rests in the incompatibility of the two stabilization mechanisms: the Marangoni mechanism relying on lateral diffusion, and the viscoelastic mechanism on immobilization of the protein molecules that constitute the adsorbed layer. One can speculate that in a mixed system, competitive adsorption of low molecular weight surfactant could weaken or interfere with the formation of protein/protein interactions in the adsorbed layer and destroy the integrity and viscoelastic properties of the adsorbed layer (see Fig. 5.10c). This could be a progressive process, with the presence of small quantities of adsorbed surfactant initially introducing faults or weaknesses in the protein film. Adsorption of more surfactant could induce the formation of protein “islands” in the adsorbed layer. These structures could be capable of slow lateral diffusion but would be too large to participate in Marangoni-type stabilization. Indeed, they could impede surfactant migration in the adsorbed layer. Adsorption of progressively more surfactant would reduce the size of the protein aggregates still further until the adsorbed protein was in its monomeric form. Ultimately, all the protein would be displaced from the interface by the surfactant.

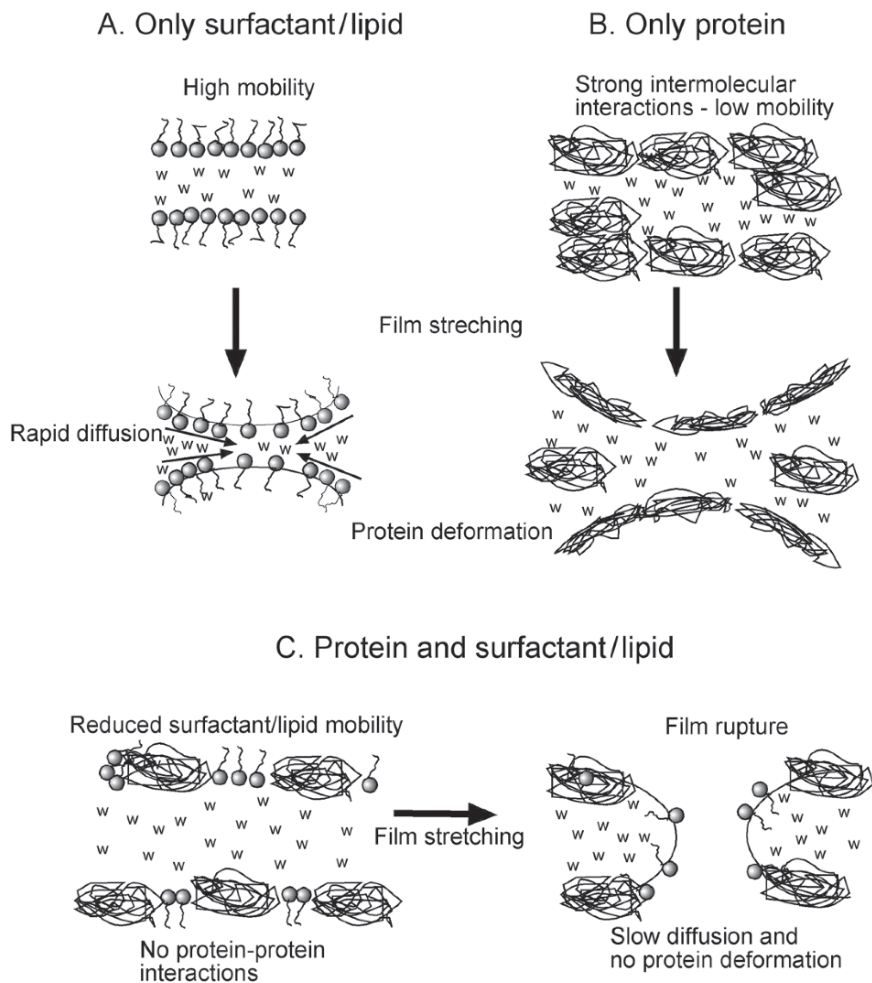

Fig. 5.10 The figure depicts possible mechanism for the stabilization–destabilization of foams with surfactants/lipids (A), proteins (B) and mixtures of the two components (C). Cross-sections of the thin films are shown where the aqueous inter-lamellar spacing is marked with (w). The stabilization of the surfactant/lipid foams are based on the high lateral mobility of the surfactant, which makes it possible to quickly restore the surface tension gradient which arises from thinning of the film, i.e., the Gibbs-Marangoni effect. For protein stabilized foam the thinning is counteracted by strong intermolecular interactions which give a viscoelastic film. For the mixed system two mechanisms can counteract each other and leads to film rupture. The figure is adapted from Clark et al. (1991a)

Two types of interaction are shown in the schematic diagram of the mixed system. First, there is an interactive process associated with the coadsorption or competitive adsorption of the two different species at the interface. Second, many of the functional proteins used in food production have physiological transport roles and therefore possess binding sites, which may allow the formation of complexes with surfactants.

A clearer understanding of this has emerged from direct study of the structures that separate the dispersed-phase of foams or emulsions, under conditions of high

dispersed phase volume (i.e., foam or emulsion thin films). Such structures form rapidly in foams following limited drainage but may occur only in emulsions after creaming of the dispersed phase.

Several factors control the emulsifier-protein interaction at the interface

On the bases of experimental data the following factors influence the way mixtures of proteins and emulsifiers, e.g., surfactants and polar lipids behave at an interface:

1. The surface activity of the individual components.

a. Competitive adsorption.

The emulsifier and proteins compete for the interface, where the most surface active and/or abundant molecule wins, depending on the ratio between surfactants and proteins in solution.

b. Displacement.

The emulsifier may, due to their higher surface activity, displace the proteins from the interface. This displacement can be hampered by a strong interaction between the protein and the interface and/or protein-protein interactions.

2. Protein-emulsifier interactions.

Increased surface activity of the emulsifier-protein complex

- (a) The binding will cause unfolding and/or increase hydrophobicity of the protein that will lead to an increased affinity to the surface.
- (b) The binding (of ionic amphiphiles) will cause precipitation at the interface due to charge neutralization.

Decreased surface activity of the emulsifier-protein complex

- (a) The binding will make the protein more soluble and hence lower the affinity for the interface.
- (b) The binding will lead to precipitation of protein lipid-complex in the bulk, which will cause loss of surface-active material.

Protein-emulsifier interactions at the interface

- (a) The interaction will give more efficient packing at the interface and thus give a higher total surface concentration.
- (b) The interaction will disrupt the protein-protein interaction in the interfacial film.

It is important to bear in mind that different modes of interaction are observed for the same system depending on the emulsifier/protein ratio. This can be for instance is manifested in the competitive adsorption of emulsifier and proteins. Studies regarding such surfactant/protein “Vroman effects”³ have been reported; for example,

³ The “Vroman effect” is the hierarchical adsorption process of blood protein, where the first proteins to be adsorbed are the relatively abundant plasma proteins, such as albumin, fibrinogen, immunoglobulin G and fibronectin, which are soon replaced by trace proteins, including factor XII (Hageman factor) and high molecular weight kininogen (HMWK) with higher affinity to the surface (Vroman et al., 1980; Brash and Hove, 1984; Horbett, 1984).

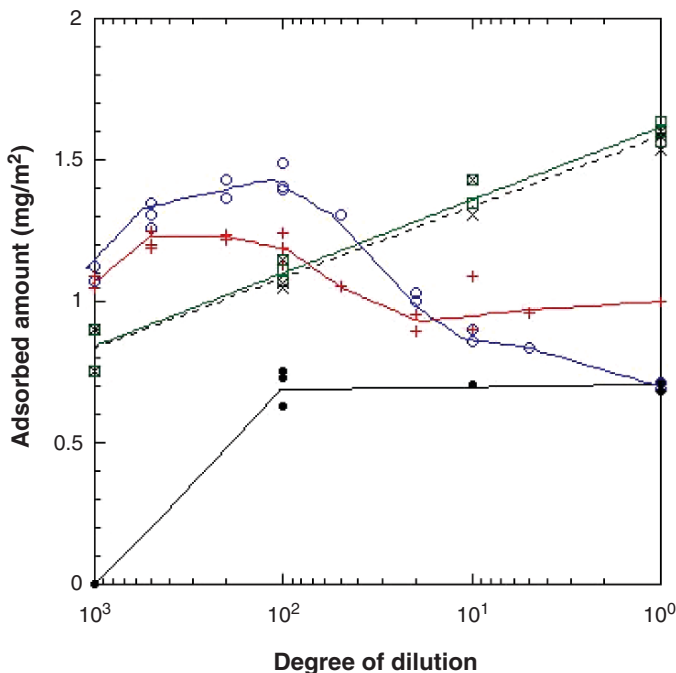

Fig. 5.11 The amounts adsorbed to a methylated silica surface as a function of degree of dilution for a mixture of β -lactoglobulin and SDS (0.2 w/w), in phosphate buffered saline pH 7, $I = 0.17$. The figure shows the adsorbed amount ($\mu\text{g}/\text{cm}^2$) after 30 min of adsorption (\circ) and 30 min after rinsing ($+$). In addition, the figure shows the adsorption of pure β -lactoglobulin, after 30 min of adsorption (\square) and 30 min after rinsing (\times). Finally, the adsorption isotherm of SDS is inserted (\bullet). Adapted from Wahlgren and Arnebrant (1992)

adsorption of fibrinogen from mixtures containing Triton X-100 passes through a maximum (Slack and Horbett, 1988). Wahlgren and Arnebrant studied the adsorption from β -lactoglobulin/SDS mixtures at different degrees of dilution (Wahlgren and Arnebrant, 1992) (see Fig. 5.11). At concentrations above the cmc for the surfactant, the amount adsorbed corresponded to a layer of pure surfactant and was found to increase after rinsing. At lower concentrations, the adsorbate prior to rinsing appeared to be a mixture of protein and surfactant, and the total amount adsorbed passes through a maximum. The amount of protein adsorbed is larger, even after rinsing, than for adsorption from pure β -lactoglobulin solutions, and it can be concluded that SDS binding in this case facilitates the adsorption of protein.

5.4.1 Influence of Emulsifier Properties

The emulsifier properties affect the interaction with proteins and surfaces as well as the structure of the formed self-assembled aggregate.

5.4.1.1 Aqueous Soluble–Surfactant Type of Emulsifiers

Wahlgren and coworkers studied the influence of different surfactant head groups on the desorption of adsorbed lysozyme (Wahlgren and Arnebrant, 1991; Wahlgren and Arnebrant, 1992; Wahlgren et al., 1993b) by surfactants at concentrations above the cmc (an exception was triethylene glycol *n*-dodecyl ether, [C₁₂E₃, which does not form micelles (Mitchell et al., 1983)]). The difference between the effect of sodium dodecylsulphate (SDS) and cationic and nonionic surfactants on protein adsorption to hydrophilic surfaces was found to correlate to the strength of binding to protein in solution. This suggests that above the critical association concentration (cac), complex formation between surfactant and protein is involved in the removal mechanism of proteins from hydrophilic solid surfaces. In the case of hydrophobic solid surfaces, the removal processes of protein by the different surfactants, including non-micelle-forming ones, are in general more similar than for the hydrophilic surfaces. This might be expected, due to the different orientation of the surfactant, and suggests a displacement mechanism, due to higher surface activity of the surfactant (Wahlgren and Arnebrant, 1992). Tilton and coworkers used the interferometric surface force technique (Israelachvili and Adams, 1978) to study the interaction between lysozyme adsorbed on mica and SDS₀ (sodium dodecane sulfonate) and SDS (Tilton et al., 1993). They found that SDS₀, which has a Krafft temperature above room temperature and hence does not form micelles, had a minor effect on the interaction between adsorbed lysozyme layers on mica, and from the small change in surface potential, they concluded that few surfactant molecules were bound to the adsorbed protein. SDS showed a similar low binding to lysozyme on mica at low concentrations (up to 0.5 cmc) but caused a collective desorption of the protein at the cmc of the surfactant, indicating that the cac to adsorbed lysozyme is in the range of its self-association limit in solution (cmc) (Froberg et al., 1999). These studies show that anionic surfactants bind to an adsorbed layer of lysozyme, which is almost neutral after binding of the positively net charged protein to the negative mica surface. The binding of surfactant thus leads to an increased negative charge of the layer, which in the case of SDS finally leads to desorption of the protein. It is likely that this is due to electrostatic repulsion between the negatively charged surface and the protein/surfactant complexes.

Nonionic surfactants are generally found to be ineffective in removing protein from hydrophilic solid surfaces (Elwing et al., 1989; Elwing and Golander, 1990; Welin-Klintström et al., 1993). As mentioned above, these surfactants bind to a very low extent to protein in solution (except when specific binding sites or pockets are present) and to the protein-covered surface. At hydrophobic surfaces, however, they usually have a considerable effect (Wahlgren and Arnebrant, 1996; Wannerberger et al., 1996). This was elegantly demonstrated in a study of surfactant interactions with proteins adsorbed at a surface with a gradient in wettability (Elwing et al., 1989).

The effect of chain length of alkyltrimethylammonium surfactants on the elutability of fibrinogen at concentrations above their cmc was found to be small at both silica and methylated silica surfaces (Wahlgren et al., 1993a). Rapoza and Horbett (1990a) did not find any effects of chain length of sodium alkyl sulfates on the

elutability of fibrinogen and albumin down to a chain length of 6 carbon atoms. However, they found, as expected, that the chain length did influence the surfactant concentration at which the onset of protein removal was initiated. The trend was similar to the one observed for the onset of other cooperative binding events (e.g., micelle formation).

Rapoza and Horbett (1990b) found that surfactants with large head groups such as Tween 20 gave lower fibrinogen elutability levels than other surfactants at polyethylene surfaces. Welin-Klintström et al. (1993) found that the elutability of fibrinogen adsorbed at surfaces with a wettability gradient decreased with the bulkiness of the hydrophobic part of the surfactant. In this connection it was also found that nonionics showed an increased removal of fibrinogen into the more hydrophilic region of the gradient surface when the cloud point (phase separation temperature) was approached (Wahlgren et al., 1995). These general observations of removal efficiency are in line with the findings from studies of the removal of fat by different surfactants (Backstrom et al., 1988; Malmsten and Lindman, 1989), where a maximum removal was achieved at conditions corresponding to an optimum in the packing of surfactant molecules at a flat interface.

Thus, it may be concluded that at high surfactant concentrations, head group effects are, as expected, most pronounced at hydrophilic surfaces but less important at hydrophobic ones. In addition, it appears that principles for detergency in general, involving the packing efficiency of molecules at interfaces, are applicable to qualitatively describe the removal of proteins from the surface.

5.4.1.2 Lipids with Low Aqueous Solubility

Electrostatics

Phospholipid - β -lactoglobulin interactions at the air - aqueous interface have been investigated by Bos and Nylander (Bos and Nylander, 1995) using the surface film balance. Some of their findings are summarized in Fig. 5.12, where the rate of incorporation of β -lactoglobulin into monolayers of distearoylphosphatidic acid (DSPA), distearoylphosphatidylcholine (DSPC) and dipalmitoylphosphatidic acid (DPPA) is shown versus surface pressure (Π) at pH 7. The rate was calculated using a simple first order kinetics model (MacRitchie, 1990), where only the surface pressure barrier is taken into account. The highest rate of adsorption of β -lactoglobulin into a phospholipid monolayer was observed for anionic DSPA. The incorporation of the protein takes also place at a higher surface pressure into a DSPA monolayer than into a monolayers of the other lipids. Since the β -lactoglobulin, with a zero net charge at pH 5.2 (Hambling et al., 1992), has a positive net charged at pH 4, a larger rate of adsorption into the negatively charged phosphatidic acid monolayers would be expected under acidic conditions. However, almost the same rates were found (Bos and Nylander, 1995). As discussed earlier, anionic lipids seems to interact more strongly with proteins, that is to their cationic amino acid residues, compared to lipids with none or positive net charge. The incorporation into the zwitterionic DSPC

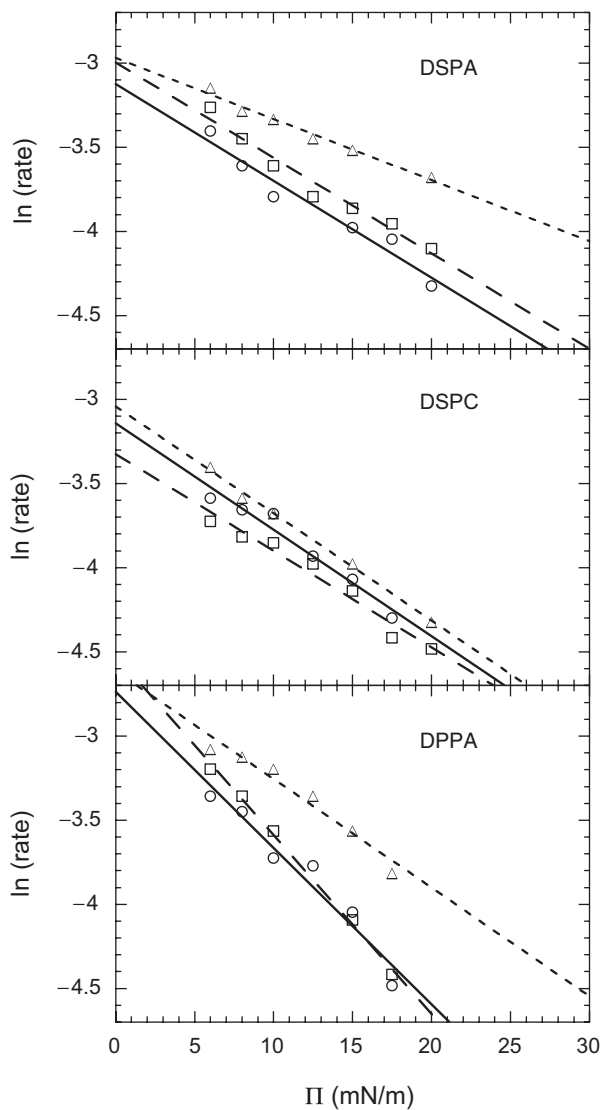

Fig. 5.12 The rate of incorporation of β -lactoglobulin into monolayers of distearoylphosphatidic acid (DSPA), distearoylphosphatidylcholine (DSPC) and dipalmitoylphosphatidic acid (DPPA), versus surface pressure (Π). The data was recorded at constant surface pressure by measuring the area increase of the lipid monolayer spread on a protein solution contain 1.15 mg/l in 10 mM phosphate buffer of pH 7, with 0 mM (— \circ —), 50 mM (— \square —) or 150 mM (- - - Δ - -) sodium chloride. The rate in mg/m^2 was calculated from the area increase by using the Π -area isotherm of spread monolayers of β -lactoglobulin. Data adapted from Bos and Nylander (1995), where also the experimental details are given

monolayers is as expected less salt dependent than what was observed for the phosphatidic acid monolayers, where the rate increases with increasing ionic strength of the subphase. Probably this is a consequence of a decreased repulsion within the phosphatidic acid protein monolayer at a higher ionic strength. The findings by Bos and Nylander (Bos and Nylander, 1995) is somewhat contradictory to the findings of Cornell and Patterson, who studied the adsorption of β -lactoglobulin in to a negatively charged lipid monolayer, composed of a mixture of palmitoylcholine (POPC) and palmitoylphosphatidylglycerol (POPG) (65/35 mol %). They only observed a substantial binding of β -Lactoglobulin at pH 4.4, which is when the protein carries a net positive charge, but not at higher pH (pH 7) (Cornell and Patterson, 1989). The differences probably arises from the different lipids and methodology used by Cornell et al. (Cornell, 1982; Cornell and Patterson, 1989; Cornell et al., 1990). Cornell et al. measured the amounts of protein adsorbed to the lipid layer by transferring the layer to a solid support. During the transfer, the surface pressure was kept at 30–35 mN/m, thus preventing insertion of portions of the protein in the lipid monolayer (Cornell et al., 1990). Only protein molecules that interact strongly with the lipid headgroups are transferred to the solid supported. Another difference is that their surface pressure data of the protein penetration is recorded under constant area, not at constant pressure as in our study. In addition Cornell et al. used lipids with their chains in the liquid state, which, as discussed below, can influence the interaction. Cornell (Cornell, 1982) also observed a specific interaction between β -lactoglobulin and egg yolk phosphatidic acid (e-PA) in spread mixed films at low pH (1.3 and 4) where β -lactoglobulin carries a positive net charge. No interaction was observed for e-PA in the neutral pH range or for egg yolk phosphatidylcholine, e-PC. Similar observations were made for the interaction between α -lactalbumin or BSA with mixed monolayers of POPC and POPG, where adsorption was observed below the isoelectric point of the protein, where the lipid layer and the protein carry opposite net charge, but less was adsorbed around and almost nothing above the isoelectric point (Cornell et al., 1990). The interaction was reduced in the presence of calcium as well as at increased ionic strength. Cornell et al. thus concluded that the interaction is of electrostatic origin.

The work of Quinn and Dawson concerning the interaction between cytochrome c (positive net charge below pH 10) and phospholipids from egg yolk also stresses the importance of the electrostatic interaction, although conformational changes of the protein are of importance (Quinn and Dawson, 1969b; Quinn and Dawson, 1969a). They measured the pressure increase caused by the penetration/adsorption of the protein to the lipid monolayers as well as the amount adsorbed by using ^{14}C -labeled protein. Their results show that the limiting pressure for penetration is 20 and 24 mN/m for phosphatidylcholine and phosphatidylethanolamine, respectively, whereas penetration into the phosphatidic acid and diphosphatidylglycerol (cardiolipin) monolayers occurred up to pressures close to the collapse pressure of the film (<40 mN/m). Furthermore, the penetration into the e-PC monolayers was not affected by increasing the sodium chloride concentration to 1 M. Cytochrome c bound to the e-PC monolayers could not be removed by increasing the ionic strength. This is in contrast to the cardiolipin and e-PA monolayers where the penetration was

reduced when the sodium chloride content was increased to 1 M. It was also possible to partly desorb some cytochrome c from e-PA monolayers. However, the pH dependence of the interaction was found to be quite complex, which suggests that subtle changes in the protein conformation also affect the interaction.

The importance of the electrostatic interaction with the phospholipid head group has also been shown by the work of Malmsten (Malmsten et al., 1994; Malmsten, 1995), who studied the interaction of human serum albumin, IgG and fibronectin from human plasma with phospholipid layers spin-coated onto methylated silica surfaces. Generally, he found no interaction between the proteins and lipids with no net charge or with shielded charges (e.g., phosphatidylcholine, phosphatidylethanolamine, sphingomyelin and phosphatidylinositol), whereas interaction was observed with the surfaces containing unprotected charges, e.g., phosphatidic acid, diphosphatidylglycerol and phosphatidylserine.

Hydrophobic Interactions

As observed in Fig. 5.12 the rate of adsorption of β -lactoglobulin into DPPA monolayers was significantly lower than into the monolayers where the corresponding lipid had a longer chain length. This points to the importance of hydrophobic interactions for the incorporation. It was also observed that the incorporation was much faster into the lipid monolayer than into its own proteinous layer, being less “oil-like” than the lipid layer (Bos and Nylander, 1995). In addition, repulsive steric and electrostatic forces might contribute the lower rate of incorporation. Quinn and Dawson (Quinn and Dawson, 1969a) found that the threshold surface pressure, above which no penetration of cytochrome c took place in phosphatidylcholine monolayers, was considerably lower when DPPA was used instead of hydrogenated egg yolk phosphatidylcholine (e-PC). The latter lipid contained fatty acid with a longer chain length, about 60% C18 and 30% C16. Du et al. (Du et al., 1996) studied the influence of the alkyl chain length of glycolipids (dialkyl glycerylether- β -D-glucosides and dialkyl glycerylether- β -D-maltosides) on the interaction between lipid monolayers and glucose oxidase. The interaction, as shown by an increase in surface pressure, was found to increase with increasing lipid chain lengths for both types of lipids. These results suggest that the hydrophobic interaction is the predominant force. Furthermore it is interesting to note that the interactions were not so strong with the lipids having the more bulky head group, that is the dialkyl glycerylether- β -D-maltosides, although the Π -A isotherms for the corresponding dialkyl glycerylether- β -D-glucosides was similar. This illustrates that a bulky head group can sterically hamper the protein-lipid (hydrophobic) interaction.

Effect of Lipid Fluidity

The complete hydrogenation of e-PC was found not to affect the surface pressure threshold for penetration of cytochrome c compared to the native e-PC (Quinn and

Dawson, 1969a). However, the change in surface pressure due to the penetration of the protein versus initial surface pressure was less steep for the saturated one. A similar trend was observed for the e-PE samples (Quinn and Dawson, 1969b). The conclusion was that the limiting pressure for penetration to take place is likely to be determined by the work necessary for the penetration, that is $\int \Pi dA$, where an area of interface, A , has to be created for the protein to penetrate. Once the penetration is feasible the magnitude will depend on the space between the molecules and thus the degree of penetration is expected to be lower for the hydrogenated sample (Quinn and Dawson, 1969a). The surface pressure threshold below which penetration of cytochrome *c* into the anionic diphosphatidylglycerol (cardiolipin) monolayer took place was also found to decrease when the lipid was fully hydrogenated (Quinn and Dawson, 1969a). Ibdah and Phillips found the same trend in their study of the effect of lipid composition and packing on penetration of apolipoprotein A-I into lipid monolayers (Ibdah and Phillips, 1988). In the biological system this protein interacts with the phospholipid membrane of the serum high density lipoprotein (HDL) particles (see discussion in oil/aqueous interface section). Their results show that for this protein adsorption occurs to a larger extent on expanded monolayers than on condensed monolayers, that is, protein adsorption decreased in the order e-PC > egg sphingomyelin > DSPC. Furthermore it was found that protein adsorption generally decreased with increasing amount of cholesterol in the lipid monolayer. It was suggested this was due to the condensing effect of cholesterol.

5.4.1.3 Other Types of Surfactants

Blomqvist et al. (Blomqvist et al., 2004; Blomqvist et al., 2006) investigated the effect of the poly(ethylene oxide)-poly(propylene oxide) block copolymers F127 (PEO99-PPO65-PEO99), molecular weight 12500 g/mol, and P85 (PEO26-PPO39-PEO26), molecular weight 4600 g/mol on β -lactoglobulin foamability and foam stability. They found that the effect of the nonionic triblock copolymer on the interfacial rheology of beta-lactoglobulin layers is similar to that of low molecular weight surfactants (Blomqvist et al., 2004). However the protein foam stability was retained in the presence of the larger polymer F127, whereas P85 largely reduced the stability (Blomqvist et al., 2006). This shows that here the size of the amphiphilic polymer has a significant effect. The presence of F127 was found to increase thickness of the foam lamellae which in turn reflects the increased steric repulsion.

5.4.2 Influence of Protein and Protein Film Structure

The stability of the proteins largely affects the interaction with the emulsifier and the interface. Differences are observed between the random coil and globular proteins. The age of the surface layer of proteins that tend to aggregate can significantly decrease the penetration of the emulsifier in the surface layer.

Even though ionic surfactants may interact, more or less specifically with charged residues of proteins, especially so at low concentrations (see Sect. 5.3), no clear relation could be established regarding the influence of protein net charge on the interaction with ionic surfactants at high surfactant concentration (Wahlgren and Arnebrant, 1991; Wahlgren et al., 1993b; McGuire et al., 1995a). This might, of course, be related to the fact that in principle all proteins contain both negative and positive charges except at extreme pH. In an effort to determine key protein parameters for their interaction with surfactants, Wahlgren and coworkers studied the DTAB-induced removal of six adsorbed proteins: cytochrome c, bovine serum albumin, α -iactalbumin, β -lactoglobulin, lysozyme, and ovalbumin from silica and methylated silica surfaces (Wahlgren et al., 1993b). For silica surfaces, it was found that the removal of the proteins that were still adsorbed after rinsing with buffer, increased with decreasing molecular weight, adiabatic compressibility [a measure of conformational stability (Gekko and Hasegawa, 1986)] and increasing thermal denaturation temperature (Wahlgren et al., 1993b). In the case of hydrophobic (methylated silica) surfaces, differences between the proteins were smaller. However, increasing molecular weight and shell hydrophobicity of the protein seemed to reduce the degree of removal. It was also found that the removal did not relate to the degree of desorption of proteins upon rinsing with buffer, indicating that the mechanisms for the two processes are different. McGuire et al. (McGuire et al., 1995b) found that the removal of wild type and structural stability mutants of bacteriophage T4 lysozyme from hydrophobic and hydrophilic silica surfaces by a cationic detergent, decyltrimethylammonium bromide (DTAB), generally increased with the stability of the mutants.

The effect of the interfacial protein film age on the displacement of the protein from the surface of emulsion drops by nonionic water soluble surfactants [Tween 20 and octaethylene glycol *n*-dodecyl ether ($C_{12}E_8$)] showed that β -lactoglobulin is harder to replace the longer the residence time was (Chen and Dickinson, 1993; Chen et al., 1993). Similar results have been obtained for a range of other protein (Bohnert and Horbett, 1986; Rapoza and Horbett, 1990b). Apart from the possible conformational changes that occur during the adsorption process, which can hamper displacement, it has been reported that β -lactoglobulin might polymerize through disulphide exchange at the oil-water interface (Dickinson and Matsumura, 1991). Consequently, the displacement of β -casein, which is a flexible and unordered protein without sulphhydryl groups, did not depend on the age of the film. Furthermore it was observed that it was harder to replace β -lactoglobulin from an emulsion prepared close to the pI of the protein, than at neutral pH, whereas the replacement from emulsions prepared at pH 3 was easier and effect of the age of the protein film was observed. Mackie et al. also studied displacement of β -lactoglobulin and β -casein by Tween 20, but from the air-water interface (Mackie et al., 1999). They also found that β -casein was more easily displaced, i.e., β -lactoglobulin films breaks at higher surface pressures. Stress invoked by penetration of the surfactant was found to propagate homogeneously through the β -casein film, which in turn resulted in growth of circular surfactant domains at the interface. β -Lactoglobulin, on the other hand was found to form elastic (gel-like) networks at the air-water interface and the penetration of the surfactant

therefore resulted in the growth of irregular (fractal) surfactant domains. Not surprisingly, Tween 20 preferentially displaced β -casein before β -lactoglobulin from a mixed β -casein/ β -lactoglobulin film at the air-water interface (Mackie et al., 2001a).

5.4.3 Influence of Surface Properties

The surface properties affect the binding of the emulsifier as well as of the protein and has therefore large effect on the competitive adsorption.

The surface activity of the complex depends on the properties of the interface, as shown by Wilde et al. (Wilde and Clark, 1993) for liquid interfaces. They found that the complex between Tween 20 and β -lactoglobulin was more surface active at the oil-water interface than at the air-water interface, where the same surface activity as for the free (or pure) protein was observed. The complexes adsorbed at both type of interfaces were however displaced by Tween 20 at the same surfactant to protein ratio. Here, we need to emphasize the difference in nature between the two types of liquid interfaces, the liquid/air and the one between two condensed media, which explains the experimental observations. The oil/water interface allows hydrophobic residues to become dissolved in and interact favorably with the oil phase, which is not possible at the air/water interface. We have also previously discussed that the unfolding of protein induced by the action of surfactants or by the presence of an interface generally leads to exposure of hydrophobic residues, that is the unfolded protein can be substantially more “oil soluble” than the native one. This relates to the following section, dealing with molecular interactions, where it will be demonstrated, that changes in oil phase composition and hence solvent properties, also can lead to changes in the structure of the adsorbed protein film.

5.4.3.1 Solid-Liquid Interfaces (Dispersions and Macroscopic Surfaces)

Protein/surfactant interactions at solid-liquid interfaces have been studied with the aim of estimating the protein attachment strength to surfaces, for optimizing detergency processes, and for avoiding undesired adsorption in biomedical applications. The major part of the work has been carried out with the purpose of characterizing the protein binding to the surface rather than the protein/surfactant interaction and therefore concerned with the degree of removal, or elution, of adsorbed protein by surfactant. Even if the data mainly refer to solid surfaces, the basic principles are also valid at liquid interfaces such as those of the emulsion droplet. Since the process of surfactant interaction with proteins at interfaces is determined by the surfactant/protein, the surfactant/surface and protein/surface interactions, the following brief introduction is intended to provide a background on surfactant association and adsorption,

The adsorption and orientation of surfactants are dependent on the type of surface. There is a vast literature concerning the association of surfactants at solid/aqueous interfaces (Scamehorn et al., 1982; Manne et al., 1994; Zhmud and Tiberg, 2005;

Zhang and Somasundaran, 2006). The structure of the surface aggregates at the plateau has been debated, and surface micelles, finite bilayers, or infinite bilayers have been suggested for hydrophilic surfaces. It has been demonstrated that nonionic polyethylene glycol monoalkyl ethers (C_nE_m) adsorb as submonolayers or monolayers on hydrophobic surfaces, while they form surface micelles or bilayer type aggregates (depending on the type of surfactant) on hydrophilic surfaces (Tiberg, 1996) (Fig. 5.13). It is therefore natural to expect that the way in which surfactants interact with proteins should be influenced by the characteristics of the surface as well.

Wahlgren and Arnebrant (Wahlgren and Arnebrant, 1991) investigated the effect of the surface properties on the displacement of adsorbed β -lactoglobulin (negative net charge) and lysozyme (positive net charge) by the cationic surfactant cetyltrimethyl ammonium bromide (CTAB) and the anionic sodium dodecyl sulphate (SDS). They used hydrophobic (hydrophobised silica), negative (hydrophilic silica), neutral (chromium oxide) as well as positively charged (nickel oxide) surfaces and found four types of behavior for surfactant concentrations well above cmc:

1. *Surfactant binds to the protein and the complex desorbs on dilution.*

This was observed for SDS and β -lactoglobulin as well as lysozyme on negative silica surface and can be explained by simple electrostatic considerations. No adsorption from SDS/protein mixtures occurred.

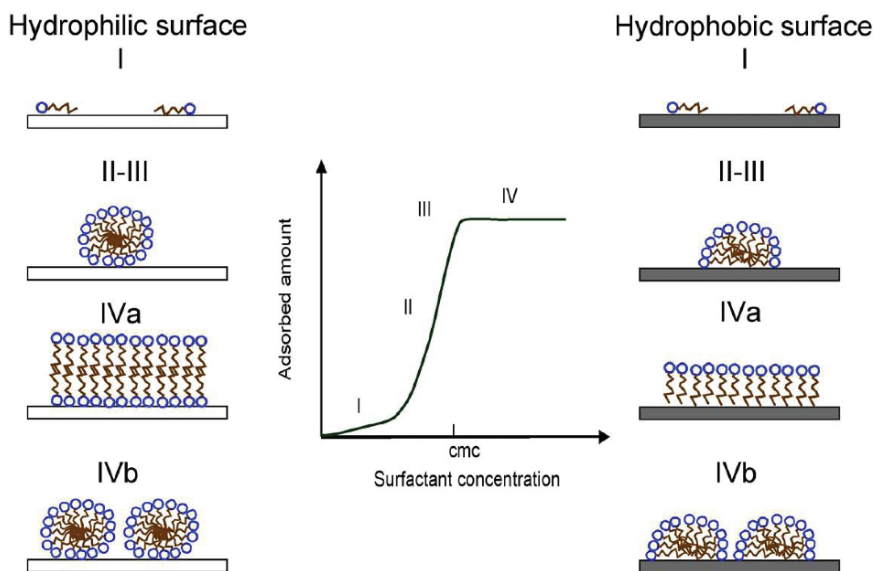

Fig. 5.13 An illustration of probable arrangements of adsorbed surfactant molecules at different degrees of surface coverage. Adsorption to hydrophilic surfaces (upper panels) and hydrophobic ones (lower panels). The illustrations are drawn to represent structures having minimal water contact with the hydrophobic parts of the molecules. The labels (I) to (IV) refer to structures that may exist in different regions of the isotherm. The figures should be considered as schematic and other structures, especially for ii to iii, have been suggested

2. *The surfactant replaces the protein at the interfaces.*

This requires that the surfactant interacts more strongly with the surface than the protein, as was observed for CTAB with negative silica and SDS and CTAB with the hydrophobic surface when the adsorbed layer consisted of β -lactoglobulin.

3. *The surfactant coadsorbs reversibly to the protein layer.*

The protein surface interaction is the stronger one and the surfactant is thus unable to solubilize the protein from the interface. This was observed for CTAB interacting with both proteins at the chromium oxide surface and SDS interacting with β -lactoglobulin at the nickel oxide surface.

4. *Partial removal of the protein.*

This can be explained as due to the presence of multiple binding sites for the protein, and can result from either mechanism 1 and 2.

Surface Charge

One can imagine several ways that emulsifiers can modulate the interaction of proteins with the surface depending on the charge of the surfactant, protein net charge and the surface charge. Here it is important to point out that ionic emulsifiers can affect the amount of protein on the surface by modifying the protein-surface interaction by changing the surface charge and/or protein charge as well as the interaction between adsorbed protein/emulsifier interaction.

Green et al. studied the interaction between sodium dodecyl sulfate (SDS) and preadsorbed lysozyme at the hydrophilic silicon oxide-water interface by neutron reflectivity measurements (Green et al., 2001). SDS binds cooperatively to the preadsorbed protein layer at intermediate surfactant concentrations, with no desorption of lysozyme from the interface. The protein was partly removed when the SDS concentration was increased to above 0.5 mM. While a surfactant concentration of 2 mM was required to completely remove both protein and surfactant from the interface. The surfactant-protein complex and the surface is then likely to both be negatively charged and the electrostatic interaction cause desorption.

Indirectly the neutron reflectivity study on the binding of SDS onto preadsorbed layers of bovine serum albumin (BSA) at the hydrophilic silicon oxide-water interface by Lu et al (Lu et al. 1998) confirm the “orogenic” displacement model (Mackie et al., 1999; Mackie et al., 2001a; Mackie et al., 2001b) discussed above. The specular neutron reflection is sensitive to the density profile normal to the interface, but does not give any lateral resolution. Their results suggest uniform layer distribution of SDS at low surfactant concentrations, while the distribution becomes unsymmetrical as the SDS concentration increases. The binding of SDS results in an expansion of the preadsorbed BSA layer from 35 Å in the absence of SDS to some 80 Å at 3×10^{-4} M SDS, which Lu et al. interpreted as a considerable structural deformation of the protein. They based this interpretation on the close agreement between the volume ratio of SDS to BSA in the mixed layer of 0.45, and the literature value for the binding of SDS onto denatured protein in the bulk reported by Tanner et al. (Tanner et al., 1982).

Investigations into the elutability of lysozyme and β -lactoglobulin from methylated silica (hydrophobic) and oxides of silicon, chromium, and nickel by SDS and cetyltrimethylammonium bromide (CTAB) showed no simple correlation between the fraction removed and the difference between the two oppositely charged surfactants. Instead, elutability of β -lactoglobulin and lysozyme decreased roughly in the order silica > chromium oxide > nickel oxide (Wahlgren and Arnebrant, 1991). In these cases the extent to which the protein is removed mainly reflects the binding mode of the protein to the surface.

Surface Hydrophobicity

Elwing et al. (Elwing et al., 1989; Elwing and Golander, 1990) studied the surfactant elutability of proteins adsorbed to a surface containing a gradient in hydrophobicity and found large differences in the amounts removed from the hydrophilic and hydrophobic ends. In the case of a nonionic surfactant (Tween 20), the elutability was largest at the midpoint of the gradient, which can be attributed to enhanced conformational changes of the adsorbed protein at the hydrophobic end, in combination with a lower efficiency of removal by nonionics at hydrophilic surfaces. At hydrophobic surfaces the removal is generally high (Elwing et al., 1989; Wannerberger et al., 1996). However, this may not be considered as evidence for weak binding of the proteins to the surface, but rather as an indication of the strong interaction between the surfactants and surface.

Horbett and coworkers (Bohnert and Horbett, 1986; Rapoza and Horbett, 1990b) studied the elutability of fibrinogen and albumin at different polymeric surfaces and found that the elutability and the change in elutability with time differed between surfaces. These differences could not, however, be correlated to surface energy in terms of their critical surface tension of wetting.

5.4.3.2 Liquid-Liquid Interfaces (Emulsions and Vesicles)

Most studies of protein-lipid interactions at the oil aqueous interface has been carried out using model emulsions. The purity of polar lipid and the way it is added (e.g., to the oil or the water phase) are bound to affect the interactions with proteins, which in turn affect the emulsion stability. Yamamoto and Araki (Yamamoto and Araki, 1997) studied this by comparing the interfacial behavior of β -lactoglobulin, in the presence of lecithin (PC) in the water or in the oil phase, with the stability of corresponding emulsions. In the presence of protein, crude lecithin was found to increase the stability of emulsion and lower the interfacial tension more effectively than a pure lecithin preparation. When crude lecithin was added to the oil phase the interfacial tension was found to decrease, and the emulsion stability increased as compared to when the lecithin was dispersed in the aqueous phase. One might speculate if these findings can be related to the presence of fatty acid and/or charged phospholipids in the crude lecithin. Aynié et al. studied the interaction between nitroxide homologues of fatty acids and milk proteins by following the mobility of

the nitroxide radicals using electron spin resonance (Aynié et al., 1992). At pH 7, the importance of the lipid protein interaction was not determined by the structure of the protein, but positively correlated with the number of positive charges on the protein. Thus, it was observed that the importance of the interaction in the emulsions decreased in the order α_{s1} -casein > β -lactoglobulin > β -casein, suggesting that the interaction was of electrostatic nature. The different proteins also affect the organization of lipid monolayer, where α_{s1} -casein in contrast to β -lactoglobulin and β -casein, induce an ordering of a monolayer of nitroxide fatty acids on the surface of an emulsion droplet (Aynié et al., 1992). This can probably be assigned to the stronger interaction of α_{s1} -casein with lipids compared to the other proteins.

Bylaite et al. applied ellipsometry to study the adsorption of the lipid from the oil and the protein from the aqueous phase at the oil–water interface (Bylaite et al., 2001). Independently of the used concentration, close to monolayer coverage of soy bean PC (sb-PC) was observed at the caraway oil–aqueous interface. On the other hand, at the olive oil – aqueous interface, the presence of only a small amount of sb-PC lead to an exponential increase of the layer thickness with time beyond monolayer coverage. This interesting observation was assigned to the formation of a multilamellar layer of sb-PC at the olive oil – aqueous interface, when sb-PC reached the solubility limit in the olive oil. The properties of the interfacial phase were found to depend strongly on whether phospholipid was added to the oil phase or to the aqueous phase as liposomal structures. In the latter case a monolayer formed, while if the phospholipid was supplied from the oil phase a lamellar phase appeared at the interface. The kinetics of the processes differs. Monolayer coverage from the liposomal dispersion is a rapid process, while the formation of the intermediate lamellar phase takes a much longer time. At very long equilibrium times (many days) the same equilibrium structure (lamellar phase at the interface) was formed. This observation agrees with presence of a third emulsifier phase at the O/W interface suggested by Friberg et al. (Friberg et al., 1969; Friberg, 1971). Westesen showed the existence of triple layers in lecithin stabilized vegetable oil emulsions using synchrotron X-ray scattering (Westesen and Wehler, 1993), but for their system they found that not more than a monolayer is needed for stable emulsions. The addition of β -lactoglobulin has also little effect on the formation and the formed DOPC layer when the DOPC is dispersed in the oil phase.

Bylaite et al. also studied the stability and droplet size of β -lactoglobulin and lecithin (phosphatidylcholine from soybean, sb-PC) stabilized emulsions of caraway essential oil as well as the amount of protein on the emulsion droplets (Bylaite et al., 2001). It should be noted that sb-PC was dispersed in the oil phase. Some of their data are given in Fig. 5.14, where the amount of β -lactoglobulin adsorbed on the oil aqueous interface is shown versus amount added s-PC. These data show that sb-PC is likely to replace some of the protein at the oil – aqueous interface, although it is unable to completely replace the protein. The maximum reduction in the amount of β -lactoglobulin adsorbed is by a factor of 3 for the caraway oil. These findings are in agreement with other studies, where lecithin was found to be less efficient in displacing milk proteins from the oil/water interface compared to other surfactants (Courthaudon et al., 1991; Dickinson and Iveson, 1993).

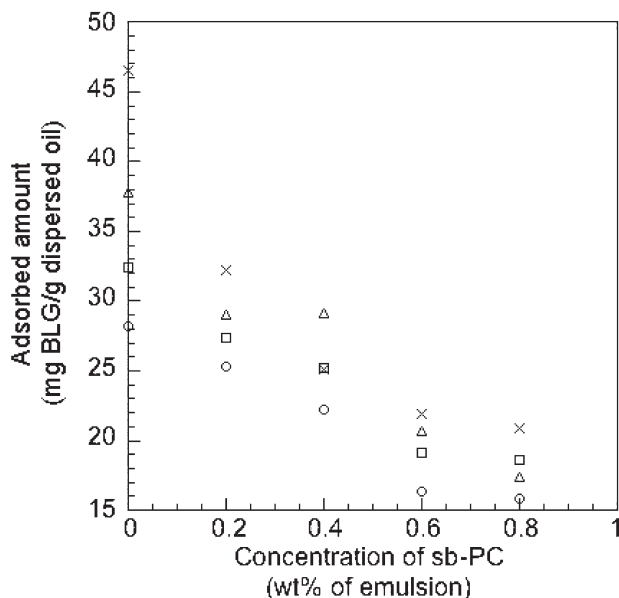

Fig. 5.14 Adsorbed amount of protein at the caraway essential oil–water (Δ , \times) and olive oil–water (O , \square) interfaces in emulsions stabilized by 1 (Δ , O) and 2 (\times , \square) wt.% β -lactoglobulin and variable amount of soybean-PC. Emulsions were prepared from 15 wt.% oil in a 60-mM phosphate buffer of pH 6.7. Data adapted from Bylaite et al. (2001), where also the experimental details are given

The displacement of caseinate from the interface of emulsion droplets by monoglycerides, monooleoylglycerol and monostearoylglycerol, dissolved in the oil phase was found to correlate with the adsorption of the monoglycerides at the oil–water interface (Heertje et al., 1990). The amount of monooleoylglycerol increased gradually with concentration and reached a plateau when approaching an oil phase concentration of 1 wt%. Under these conditions all of the caseinate was displaced from the interface. The saturated lipid, monostearoylglycerol, was much more efficient in displacing the protein. Already, at a concentration in the oil phase of between 0.2 and 0.3 wt% the adsorbed amount of monostearoylglycerol increased sharply and reached much higher surface concentrations than monooleoylglycerol. At 0.3 wt% all of the caseinate was removed from the interface.

Protein Interactions with Lipid Vesicles

The mechanisms that determine the stability, size and shape of vesicles are complex and widely discussed (for reviews see for instance Helfrich, 1989; Lasic, 1993; Komura, 1996; Lasic et al., 2001). The spherical shape is generally the most stable shape for equal distribution of molecules between the two monolayers constituting the bilayer (Lasic, 1993). These spherical vesicles can be large multilamellar vesicles

(MLV), and large (LUV) and small (SUV) unilamellar vesicles (Lasic, 1993). The bending of the lipid bilayer to form a vesicle imposes a strain on a symmetric bilayer as the inner monolayer has a negative curvature, while the outer has a positive curvature. The magnitude of this curvature energy can be difficult to estimate, but it is thought to be significant enough to in many cases make the vesicles inherently unstable and energy has to be added to form them (Lasic, 1993; Komura, 1996; Lasic et al., 2001). The result of the tension can be nonspherical vesicles (Seifert et al., 1991). A mixture of phospholipids, which corresponds to the composition in the milk fat globule membrane, gives both spherical vesicles and tubular structures (Waninge et al., 2003). In particular compositions (e.g., 80% DOPE, 12% DOPC and 8% sphingomyelin) that at high lipid content give liquid crystalline phases at the boundary of lamellar to reversed hexagonal phase tend to give microtubular structures at high water content rather than vesicles. A larger proportion of multilamellar vesicles were observed in buffer and divalent salts than in pure water. A small increase in the interlayer spacing of the multilamellar vesicle was observed in the presence of β -lactoglobulin and β -casein.

Driving Force for the Protein-Vesicle Interaction

The driving mechanism for the interaction of proteins with the lipid bilayer of the vesicles are basically as for the interaction a lipid monolayer at the air-aqueous interface. In parallel to the Quinn and Dawson study discussed above (Quinn and Dawson, 1969b; Quinn and Dawson, 1969a), Rytömaa et al. (Rytömaa et al., 1992) found a strong electrostatic contribution when cytochrome c binds to cardiolipin-phosphatidylcholine liposomes. This interaction did not take place if the negatively charged lipid cardiolipin was absent in the membrane. Furthermore, the protein was dissociated from the vesicle in the presence of 2-mM $MgCl_2$ and 80-mM NaCl at pH 7. The apparent affinity of cytochrome c to the vesicles also increased when the pH was dropped to 4. The interaction was found to be completely reversible for pH changes, that is, if the pH was increased to 7, the protein could be dissociated from the vesicle by adding salt.

Price et al. studied the adsorption of fibrinogen to neutral liposomes, composed mainly of phosphatidylcholine (PC) and cholesterol and negative liposomes, composed mainly of phosphatidic acid (PA) and cholesterol, as well as to the corresponding liposomes in which a PEG-modified phosphatidylethanolamine had been introduced (Price et al., 2001). They found that negatively charged liposomes adsorbed more fibrinogen than the corresponding neutral liposomes. PEG modification was found to have no effect on neutral liposomes in terms of fibrinogen adsorption. However, PEG modification, which sterically stabilizes the liposomes, markedly reduced the adsorption to the negative liposomes.

Brooksbank et al. conducted an extensive study on the interaction of β -casein, κ -casein, α_{s1} -casein, and β -lactoglobulin with negatively charged egg yolk phosphatidylglycerol (PG) and zwitterionic egg yolk phosphatidylcholine (PC) vesicle using photon correlation spectroscopy (Brooksbank et al., 1993). Their data on the

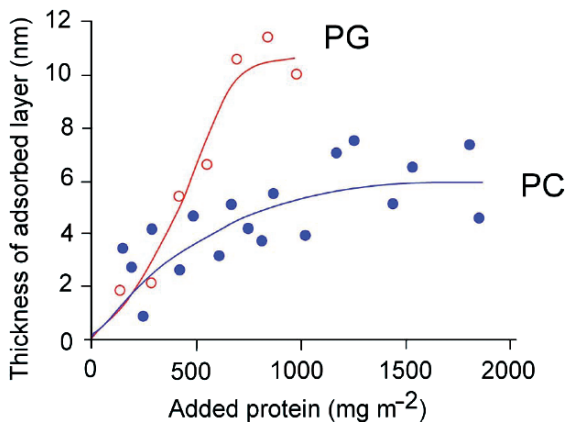

Fig. 5.15 Thickness of adsorbed layer of β -casein on negatively charged egg yolk phosphatidylglycerol (PG) and zwitterionic egg yolk phosphatidylcholine (PC) vesicle as a function added protein expressed as μg of protein per square meter of available liposome surface. The liposomes were dispersed in 160 mM and the pH was about 6.2. The data are taken from a photon correlation spectroscopy study by Brooksbank et al. (1993), where further experimental details are given

adsorption of β -casein are shown in Fig. 5.15. All of the studied proteins were found to give a thicker layer on the negatively charged vesicles, although they all carried a negative net charge under the conditions used (160-mM sodium chloride at pH 6.2). Brooksbank et al. (Brooksbank et al., 1993) suggested that binding to the vesicle surface takes place mainly through hydrophobic interactions and the differences in thickness of the adsorbed layers on the two types of vesicles were explained in terms of the protein charge distribution. For instance the hydrophilic, N-terminal, part of β -casein has a net charge of -12 , whereas the remainder of the molecule carries almost no net charge. Thus, on the negatively charged vesicle surface, the molecules adopt a more extended configuration as the N-terminal part is likely to be pushed away from the surface by means of electrostatic repulsion. This explains the thicker layers on this surface as shown in Fig. 5.15. A similar reasoning can be applied for κ -casein. The apparently very thick adsorbed layer of α_{s1} -casein was explained by bridging flocculation of the vesicles mediated by the protein. The middle section of α_{s1} -casein carries a negative net charge, while the two ends have no net charge. One of the uncharged ends protrudes into the vesicle bilayer and the middle section is repelled from the vesicle surface, leaving the other uncharged end of the peptide chain free to interact with another vesicle. The charge distribution on β -lactoglobulin is more even and the interpretation of the results was not as straightforward.

As discussed by Kinnunen the introduction of a H_{II} forming double chain lipid (a lipid with packing parameter > 1 , see Fig. 5.2) in a lamellar membrane can impose a considerable stress on the membrane (Kinnunen, 1996). This frustrated membrane is said to be in the L_e state according to the Kinnunen terminology (Kinnunen, 1996).

Free energy can be gained by allowing some of the lipids in the frustrated membrane to adopt the so-called extended or splayed chain conformation, where one of the acyl chains extends out from the bilayer, while the other chain remains in the membrane. Such an extended chain can also become accommodated within a proper (hydrophobic) cavity of a protein interacting with the membrane (Kinnunen 1996). This is an interesting alternative explanation for the hydrophobic interaction between peripheral proteins and membranes that has been discussed in this review. The splayed chain conformation has also been suggested to be one mechanism for membrane fusion (Kinnunen and Halopainen, 2000). This and other implications of the splayed chain confirmation has been discussed by Corkery (Corkery, 2002).

Influence of the Protein Structure on the Vesicle Interaction

Kim and Kim studied the interaction between α -lactalbumin and phosphatidylserine/phosphatidylethanolamine vesicles (1:1 molar ratio) versus pH (Kim and Kim, 1986). They found that the interaction, which almost did not exist at neutral pH, increased with decreasing pH (Fig. 5.16). What is interesting to note (Fig. 5.16), is

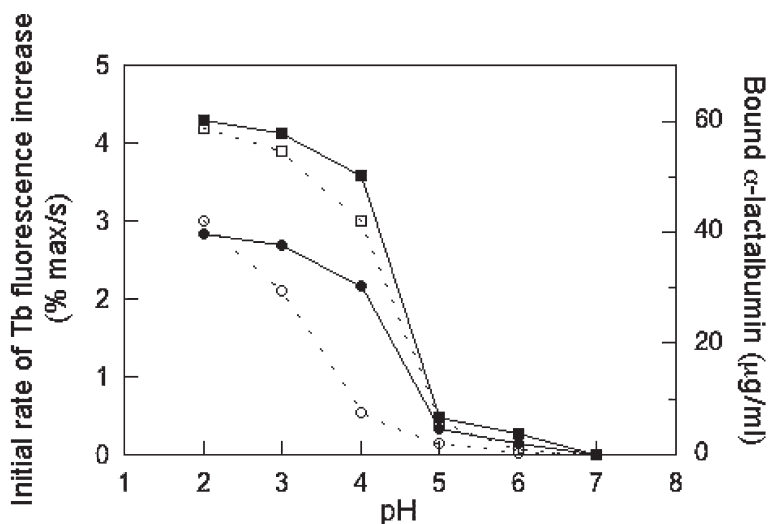

Fig. 5.16 The initial rate of Tb fluorescence increase (--- ○ ---, --- □ ---) upon α -lactalbumin induced fusion of phosphatidylserine/phosphatidylcholine (1:1 molar ratio) vesicles is shown as a function of pH. The pH-dependent binding of α -lactalbumin is shown as the amount of protein bound per ml vesicle suspension (●, ■), which contained 1-mM lipid molecules (determined from the phosphorous content) per ml suspension. The results for initial protein concentrations of 50 (○, ●) and 100 (□, ■) $\mu\text{g/ml}$ are presented. As the curves for the fusion process represents kinetic data and the binding studies represent equilibrium data when the fusion process is over, only qualitative comparison is possible. Data adapted from Kim and Kim (1986), where also the experimental details are given

that vesicle fusion, as estimated from increase of the initial rate of Tb fluorescence increase, correlates with the binding of the protein to the vesicles. The binding was suggested to be due to hydrophobic interaction via protein segments penetrating into the lipid bilayer as it was impossible to dissociate it by increasing the pH. This was further confirmed by using proteolytic enzymes, which were found to cut off both ends of the polypeptide chain leaving only the segment that penetrate into the bilayer. This penetrating protein loop was also believed to induce fusion of the vesicles.

The importance of the protein conformation on the interaction with vesicles was also shown in the study of Brown et al. (Brown et al., 1983). They found no interaction between native β -lactoglobulin and DPPC vesicles, but β -lactoglobulin, modified by exposing it to a 2:1 mixture of chloroform and methanol, did interact with the vesicles. Moreover, the lipid-protein complex formed had an α -helix content of at least 25–30% larger than for the native protein. The interaction was found to lead to aggregation of the vesicles at pH 7.2, while no aggregates were observed at 3.7. This was explained by the larger net charge at pH 3.7 (+20) compared to pH 7.2 (–10). These results imply that protein modification, either during processing or by special treatment, can increase the helix content, which in turn can be boosted by lipid interaction. The lipid-protein complexes formed in such a way have been suggested as a way to improve the emulsification processes (Brown, 1984; de Wit, 1989).

Lateral Phase Separation in Vesicle Bilayers

Raudino and Castelli reported that the presence of lysozyme could induced lateral phase separation in vesicle bilayers composed of a mixture of phosphatidic acid and phosphatidylcholine (Raudino and Castelli, 1992). Their differential scanning calorimetry study of the lipid chain melting transition showed good mixing in absence of the protein and the single peak was shifted towards higher temperatures as the phosphatidic acid content increased. In the presence of lysozyme, however, the chain melting transition peak was split into two peaks, indicating a lateral phase separation. In addition they found that temperature of protein unfolding increased with the fraction of phosphatidic acid, suggesting a stabilization of the protein due to the interaction with phosphatidic acid.

It is important to bear in mind that microheterogeneity of the bilayer does not only occur for mixtures of different lipids, but also close to the gel-to-fluid phase transition of the lipid. Hønger et al, studied the relation between phospholipase A₂ catalyzed hydrolysis of one component phosphatidylcholine vesicles and the microheterogeneity of the lipid bilayer (Hønger et al., 1996). They varied the microheterogeneity by changing the temperature in the vicinity of the gel-to-fluid phase transition as well as using lipid chain lengths between C14 to C18 and found a strong correlation between the maximal lipase-lipid interaction and the maxima in interfacial area between gel and fluid domains.

5.4.3.3 Liquid-Air Interfaces (Foams)

Emulsifiers with High Aqueous Solubility

Adsorption of Emulsifier-Protein Complexes

Tween 20 and β -lactoglobulin are known to interact in solution to form a 1:1 complex characterized by a $K_d = 4.6 \mu\text{M}$, which has an increased hydrodynamic radius of 5.7 nm compared to 3.5 nm for β -lactoglobulin alone (Clark et al., 1991a). Detailed measurements of the properties of foam films formed from a constant concentration of 0.2 mg/mL mixed native and fluorescein-labeled β -lactoglobulin as a function of increasing Tween 20 concentration (Wilde and Clark, 1993; Clark, 1995) have been reported. This study revealed that between molar ratios (R) of Tween 20 to β -lactoglobulin of 0.2 to 0.9, there was a progressive increase in the thickness of the foam films and a corresponding decrease in the amount of adsorbed protein to an intermediate level of approximately 50% of that which was originally adsorbed. These changes occurred prior to the onset of surface diffusion of the labeled protein as determined by the FRAP technique at $R = 0.9$ (Coke et al., 1990). One persuasive interpretation of the data is that coadsorption or trapping of the Tween 20/ β -lactoglobulin complex in the adsorbed multilayers could account for adsorbed-layer thickening (Clark et al., 1994a), since the complex is known to have an increased hydrodynamic radius (Clark et al., 1991a). However, further studies have showed that the increase in thickness was mainly due to the displacement of the protein by the surfactant. AFM studies showed that surfactant domains were formed which expanded and compressed the protein rich matrix (Mackie et al., 1999) increasing its thickness prior to complete displacement of the protein. This phenomena was observed in all protein surfactant systems despite the absence of specific protein-surfactant interactions (Mackie et al., 2001b; Mackie and Wilde, 2005). Comparing nonionic and ionic surfactants showed that the headgroup nature had specific impacts on the structure of the interfacial film. Nonionic surfactants generally formed domains in the protein matrix, which expanded as more surfactant was added. However, ionic surfactants (both anionic and cationic) both formed a greater number of smaller domains than nonionic surfactant (Gunning et al., 2004) and displaced the protein via the minimal expansion of a larger number of domains. Computer simulations also showed similar surface structures when the interaction potentials between the proteins and surfactants were varied (Wijmans and Dickinson, 1999; Pugnali et al., 2004). This suggested that nonionic surfactants in general had a net repulsive interaction with adsorbed proteins, probably due to steric repulsion, whereas ionic surfactants had a relatively more attractive interaction with adsorbed proteins. This is probably due to the fact that although the protein has a net charge, they are polyelectrolytes with both negative and positive charges, thus, some parts of the protein will be attracted to an ionic surfactant, irrespective of its charge.

Further evidence supporting direct adsorption of the complex formed between β -lactoglobulin and Tween 20 comes from dynamic surface tension (γ_{dyn}) measurements performed using the overflowing cylinder apparatus (Clark et al., 1993). Inclusion of β -lactoglobulin (0.4 mg/mL) in the initial solutions caused only a small reduction in

the measured γ_{dyn} to 71 mN/m. This remained unaltered in the presence of Tween 20 up to a concentration of 15 μM . Above this concentration a small but significant further reduction in γ_{dyn} was observed. The effect resulted in a small inflection in the γ_{dyn} curve in the region corresponding to 15 to 40 μM Tween 20. At higher Tween 20 concentrations, the curve for the mixed system followed that of Tween 20 alone. The inflection in the γ_{dyn} isotherm observed for the mixed system at concentrations of Tween 20 greater than 10 μM could not be due to adsorption of Tween 20 alone since under the prevailing conditions, the concentration of free Tween 20 was reduced by its association with β -lactoglobulin. Using Equation (5.5) it can be shown that the Tween 20/ β -lactoglobulin complex is the dominant component in solution in the Tween 20 concentration range of 15 to 35 μM (Clark et al., 1993).

Direct adsorption of complex at the air/water interface also appears to have importance in functional properties of certain lipid-binding proteins from wheat called “puroindolines” (Wilde et al., 1993; Dubreil et al., 1997; Biswas and Marion, 2006). These proteins show unusual behavior in the presence of lipids that they bind, in that their foaming properties are generally unaltered and in some cases enhanced. A systematic study of the influence of interaction with lysophosphatidyl cholines (LPC) of different acyl chain lengths and has produced persuasive evidence of the importance of the complex on foaming activity (Wilde et al., 1993). First, two isoforms of the protein were investigated, puroindoline-*a* and -*b* (the *b* form has also been referred to as “friabilin”). Puroindoline-*b* has a significantly increased K_d for LPC compared to puroindoline-*a* (i.e., 20-fold weaker binding) and the enhancement of foaming properties is correspondingly reduced in the *b* form. Further studies of the binding of LPC to the *a* form revealed that the binding became tighter with increasing acyl chain length, and higher concentrations of the short-chain-length LPC are needed to achieve optimal foam stability enhancement (Husband et al., 1995). Lauryl-LPC showed no interaction with the puroindoline-*a* until the levels present exceeded the critical micelle concentration of 400 μM . This indicates a cooperative binding since it takes place in this concentration range, and any of the suggested structures for the protein/surfactant complexes, e.g., the pearl and necklace structure (Fig. 5.6), could be applicable. It seems increasingly likely that the functional properties of the puroindolines are linked to a role in the transport and spreading of lipid at the air/water interface.

When comparing the data for the interaction between SDS and ovalbumin and the corresponding data for BSA we clearly observe the different mode of interaction (Fig. 5.17b). The gradual decrease in surface tension with increasing surfactant concentration observed for ovalbumin and SDS mixtures can be explained by more efficient packing at the interface as discussed below. In addition, it has been argued that the attractive electrostatic interaction between surfactant and protein might increase the hydrophobicity and hence the surface activity of the protein. The specific binding of SDS to BSA does not affect the surface tension until the concentration corresponding to saturation of the high affinity binding sites is reached, that is 9–10 mole SDS per mole protein (Makino, 1979), where a sharp decrease in surface tension is observed. This arises probably from an increase in the free monomer concentration of SDS. The second plateau, indicating constant surfactant monomer concentration,

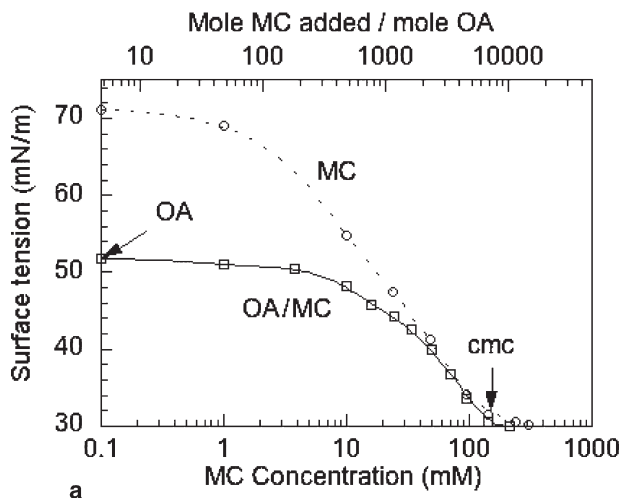

Fig. 5.17a Surface tension isotherms of 21 μM ovalbumin (OA) (\square) in the presence of the nonionic monocaprin (MC) in water adjusted to pH 5.6, where the surface tension of the pure protein is marked with an arrow on the ordinate. Surface tension of pure MC is also shown (\circ) and the cmc is marked with an arrow on the abscissa. The surface tension measurements were performed according to the drop-volume method as a function of time. The surface tension value after 2000 s has been used for the isotherms. Further details are given elsewhere (Ericsson and Hegg 1985)

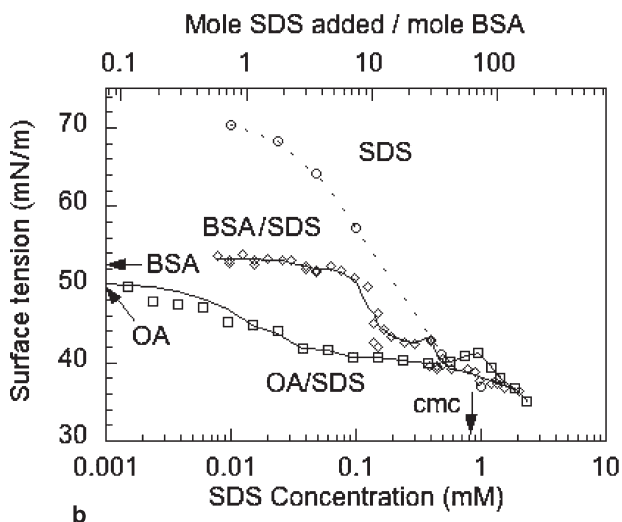

Fig. 5.17b Surface tension isotherms of 21- μM ovalbumin (OA) (\square) and 13- μM bovine serum albumin (BSA) (\diamond) in the presence of the anionic sodium dodecylsulphate (SDS) in 0.05-M phosphate buffer, pH 5.6. The surface tension of the pure proteins are marked with arrows on the ordinate. Surface tension of pure SDS is also shown (\circ) and the cmc is marked with an arrow on the abscissa. Other conditions are the same as given under Fig. 5.17a

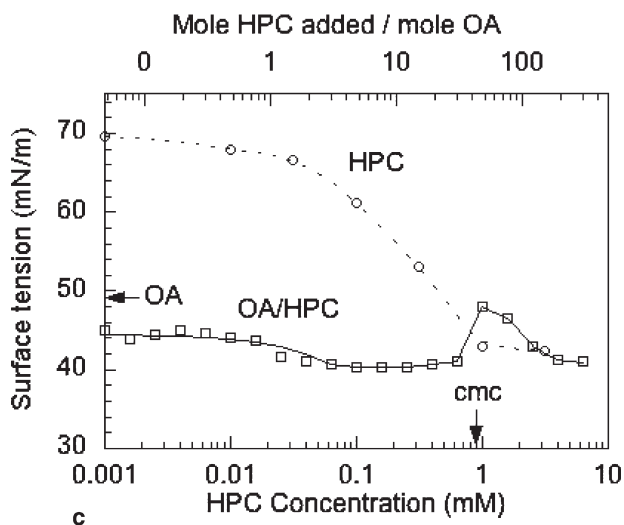

Fig. 5.17c Surface tension isotherms of 21- μ M ovalbumin (OA) (\square) in the presence of the cationic hexadecylpyridinium chloride (HPC) in water adjusted to pH 4.0. The surface tension of the pure protein is marked with an arrow on the ordinate. Surface tension of pure HPC is also shown (\circ) and the cmc is marked with an arrow on the abscissa. Other conditions are the same as given in Fig. 5.17a

which is observed at increased surfactant concentration is likely to be connected with saturation of the cooperative binding sites. As surfactant concentration further increases the surface tension isotherms for the two protein surfactant mixtures coincide. The second plateau observed in surface tension isotherms for ovalbumin and HPC mixtures just below cmc of HPC (Fig. 5.17c), can be related to the electrostatic interaction between HPC and globular proteins that has been observed below cmc in bulk solution (Ericsson et al., 1987a). It is noteworthy that the surface tension is slightly lower than for pure HPC, suggesting that the complex is more surface active. Green et al. used specular neutron reflection and surface tension measurements to study the adsorption of lysozyme and SDS at the air–water interface (Green et al., 2000). Their results show that the lysozyme-SDS complexes are much more surface active than the unbound species as the surface excesses for both lysozyme and SDS increases and surface tension decreases upon addition of SDS (region A). Interestingly the molar ratio of SDS to lysozyme was found to remain constant at about 7, although the total surface excesses increase with SDS concentration up to a surfactant concentration of 2.5×10^{-4} M. This indicates that the complex that adsorbed on the interface had a rather well-defined stoichiometric composition. Further increase in SDS concentration beyond 2.5×10^{-4} M lead to a sharp decrease in the total surface excess, while the molar ratio of SDS to lysozyme increased. Eventually, as more SDS was added, the mixed protein/surfactant layer was replaced by a pure SDS monolayer. The zwitterionic surfactant LPC was found to enhance the foaming

properties of β -lactoglobulin (Sarker et al., 1995). An enhanced adsorption of this complex, and an increase in the elastic properties of the mixed interface were also found, which could be linked with enhanced electrostatic interactions between the adsorbed protein and surfactant (Gunning et al., 2004).

Decreased Surface Activity of the Emulsifier–Protein Complex

The maxima in the surface tension isotherm at HPC concentrations between 0.8 and 2.5 mM probably reflects an increased HPC-ovalbumin interaction in bulk solution (Fig. 5.17b). The formed highly charged complex is less surface active and an increase in surface tension is thus observed. The surface tension maximum has been found to depend on ovalbumin concentration, and is shifted towards higher HPC concentration at increased ovalbumin concentration (corresponds to 30 mole HPC per mole ovalbumin, independent on protein concentration) (Ericsson, 1986). The adsorption from mixtures of human serumalbumin (HSA), and nonionic surfactant, decyl-dimethyl-phosphine-oxide (C_{10} DMPO) at the air–water interface was reported by Miller et al. (Miller et al., 2000b). They reported an anomalous surface tension increase for the mixtures at low surfactant concentrations to values higher than for the protein at the same concentration without the surfactant. Thus it seemed that surfactant protein complex was less surface active. The likely explanation is that the nonionic surfactant associate with HSA via hydrophobic interaction and thus makes the protein more hydrophilic and hence less surface active. Miller et al. also observed that the concentration range, where the coverage of protein and surfactant are comparable in the mixed surface layer was quite narrow (Miller et al., 2000b).

The precipitation of protein in the bulk solution due to neutralization by added surfactant can also cause a decrease in surface concentration due to loss of surface active material. Garcia Dominguez et al. (Garcia Dominguez et al., 1981) have shown that the surface tension reduction of lysozyme and insulin at pH 3.5 (i.e., below pI) decreased when an anionic surfactant (SDS) was added, due to precipitation of the protein.

The Lateral Electrostatic Interactions Can Control the Layer Composition

A synergistic effect on surface tension is seen for mixtures of proteins with both the anionic and cationic surfactant (Fig. 5.17b and c). For ovalbumin and SDS mixtures (Fig. 5.7b), a gradual decrease of the surface tension with increasing surfactant concentration is observed. This might be assigned to the more efficient packing in the formed mixed surfactant/protein layer compared to the one formed by the individual components at this concentration (Ericsson and Hegg, 1985). Even at the lowest concentration of cationic surfactant (0.05 mole HPC per mole ovalbumin), where the pure surfactant has the same surface tension as water, a decrease in surface tension for the protein surfactant mixture, compared to pure ovalbumin, is observed (Fig. 5.17c). It is unlikely that any bulk interaction will affect the interfacial behavior at this low HPC to ovalbumin ratio. Therefore the lowering in the surface tension probably arises from molecular interactions in the adsorbed surface film, giving a more

condensed surface layer. Buckingham et al. (Buckingham et al., 1978) found strong synergistic lowering of the surface tension of a mixed solution of SDS and poly-L-lysine at conditions at which no precipitation, micelle or complex formation take place in the bulk solution. Similar behavior was observed in mixtures of low molecular weight surfactants of opposite charges (Lucassen-Reynders et al., 1981). This effect has been assigned to the reduction of electrostatic repulsion within the layer.

5.4.3.4 Emulsifiers with Low Aqueous Solubility

The large number of studies using lipid monolayers at the air/aqueous interface and spread or adsorbed proteins have given us the basic knowledge of the interaction between proteins and polar lipids with low aqueous solubility.

Monolayer Stability

One might expect that monolayer made up of lipids with very low aqueous solubility would be stable. However, this is far from general. Metastability of monolayers, can be caused by processes such as rearrangement within the layer, dissolution into the sub-phase and transformation to a three dimensional phase, which can occur at pressures above the equilibrium spreading pressure (Vollhardt, 1993; Vollhardt et al., 1996). Furthermore, the stability of the monolayers can be affected by the spreading solvent and the techniques used for spreading the lipid (Gericke et al., 1993; Carlsson et al., 1995) The stability of the monolayer can also be considerably changed by the ion composition of the aqueous sub-phase. For instance the stability of an arachidic (n-eicosanoic, C20:0) acid monolayer was found to increase in the order

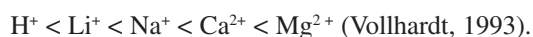

There are several examples of proteins that are thought to have the role to stabilize a lipid mono- or bilayer. One such example is the milk fat globule membrane that has been suggested to consist of the monolayer of polar lipids, which covers the fat globule surface, and an outer lipid based bilayer (Danthine et al., 2000; Mather, 2000). The milk fat globule membrane is expected to be inhomogeneous with significant amount of proteins in the membrane. An aqueous layer containing different proteins, like xanthine oxidase, is present between the monolayer and bilayer. One of the roles that have been assigned to xanthinoxidase is to stabilize the milk fat globule membrane (Mather, 2000). Interestingly, Kristensen et al, found that the presence of a xanthine oxidase can increase the stability of a monolayer composed of sphingomyelin from the milk fat globule membrane (Kristensen et al., 1996). They investigated the interaction between one of the major proteins, xanthine oxidase, and the major lipids, sphingomyelin and phosphatidylcholine, in the milk fat globule membrane at the air / aqueous interface by using the monolayer technique. Both lipids have a similar

phosphorylcholine headgroup, which is zwitterionic in the neutral pH range, although the belt regions linking the phosphorylcholine group with the acyl chains are different. The Π -A isotherms of sphingomyelin and phosphatidylcholine are shown in Fig. 5.18a and b, respectively. The isotherms for sphingomyelin monolayers spread

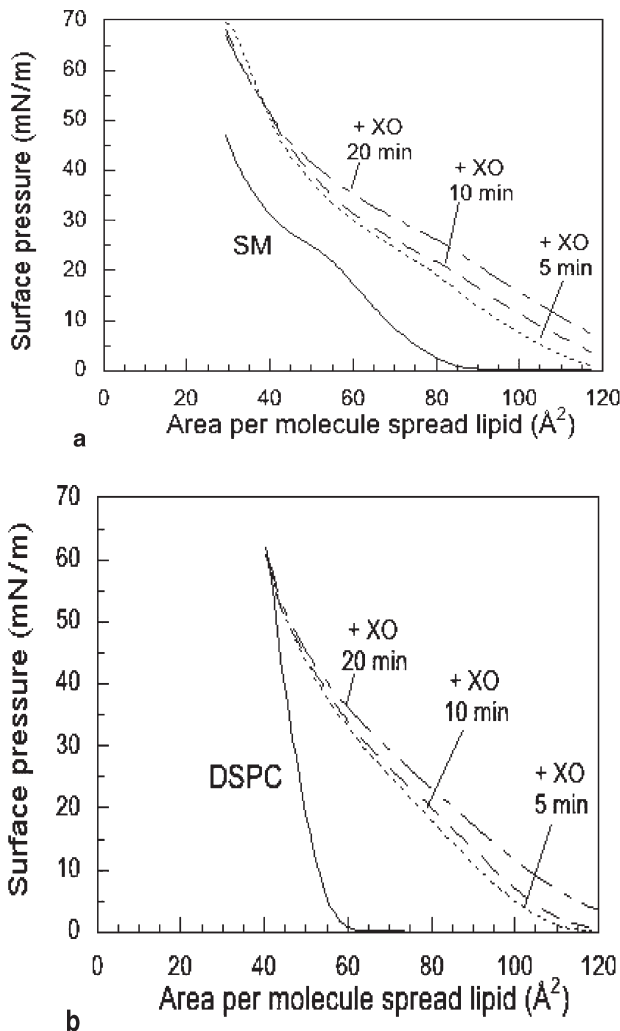

Fig. 5.18 Dynamic surface pressure (Π) as a function of the molecular area of the spread amount lipid for compression of (a) sphingomyelin and (b) distearoylphosphatidylcholine (DSPC) monolayers on a phosphate buffered subphase (40-mM phosphate containing 0.1-M sodium chloride, pH = 7.4) with or without xanthine oxidase (5 mg/ml). The isotherms recorded for the lipid spread on pure buffer (-) and at 5 (-----), 10 (— — — —), 20 (— · — ·) min elapsed between spreading on xanthine oxidase solution and compression. The lipid (25 μ g) was spread from a chloroform/methanol (2:1, v/v) solution on a maximum area of 50 \times 450 mm² and a compression speed of 12.5 mm/min was used. Data adapted from Kristensen et al. (1996), where also the experimental details are given

on pure buffer and a xanthine oxidase solution are shown. The slope of isotherm and the area of the compressed monolayer for pure sphingomyelin (Fig. 5.18a) are smaller than expected for these types of lipids. In addition, the large hysteresis and the dependence on the compression speed, not observed for distearoylphosphatidylcholine, confirms that the sphingomyelin monolayer is metastable. The difference in stability of monolayers formed by two different lipids can probably be related to the different conformation of choline groups in the two types of lipids, where intra molecular hydrogen bonding is possible between the phosphate group and the amide and hydroxyl groups in the belt region of sphingomyelin (Siminovitch and Jeffrey, 1981). An increase in m ; at maximum compression of the sphingomyelin monolayer, which reflects an increase in the monolayer stability, was observed in the presence of sphingomyelin. Furthermore, the area per sphingomyelin molecule increases in the presence of xanthine oxidase even at high Π -values. This is in contrast to the results from the parallel study of the phosphatidylcholine monolayers with and without xanthine oxidase, where the interacting protein could be completely squeezed out from the lipid monolayer at high enough surface pressures without affecting the collapse pressure. This indicates that interaction between xanthine oxidase and sphingomyelin is much stronger than that between the protein and phosphatidylcholine.

Structure of the Interfacial Film

Even from the study of the penetration of protein versus surface pressure it is also possible to get some hints about the structure of the mixed layer. Cornell et al. (Cornell, 1982; Cornell and Patterson, 1989; Cornell et al. 1990) observed penetration of β -lactoglobulin, α -lactalbumin or BSA into mixed monolayers of POPC and POPG at such high surface pressure that it is unlikely that the proteins could penetrate into a protein layer. Thus, they concluded that the formation of pure protein patches is unlikely and that portions of the protein are suggested to be intercalated into the lipid monolayer. Bos and Nylander made similar observation for the interaction between β -lactoglobulin and DSPC and DSPA monolayers (Bos and Nylander, 1995).

Fluorescence microscopy and Brewster angle microscopy (BAM) can be used to in situ image the structure of the film at the air/aqueous interface, although the lateral resolution is limited by the resolution of the optical microscope. Fluorescence microscopy together with surface film balance technique was used to by Heckl et al. to study the structure of mixed phospholipid-cytochrome c and b films (Heckl et al., 1987). They found that proteins mainly were located in the fluid membrane phase, which coexisted with solid lipid domains without protein. The penetration into the lipid monolayer was reduced with increasing pressure. Cytochrome c (positively charged) was found to interact with dimyristoylphosphatidic acid (DMPA) monolayers but not with dipalmitoylphosphatidylcholine (DPPC) layers, showing the electrostatic nature of the interaction. Schönhoff et al. concluded from their study of the incorporation of membrane proteins into DPPA/DOPA monolayers that incorporation mainly takes place in the fluid phases of the matrix (Schönhoff et al., 1992). Zhao et al. used BAM to image the kinetics of β -lactoglobulin penetration

into DPPC monolayers at the air-aqueous interface from a 500-nM solution in 10-mM phosphate buffer, pH 7 (Zhao et al., 2000). For instance at an initial surface pressure of 7.8 mN/m, it took 0.17 min until domains, with similar morphology as those appearing during the compression of a pure DPPC monolayer, appeared. These domains were found to consist only of the lipid as confirmed by grazing incidence X-ray diffraction and β -lactoglobulin penetration was found to occur without any specific interaction with DPPC. β -Lactoglobulin was not able to penetrate into a condensed DPPC monolayer, that is, above surface pressure of about 20 mN/m.

The lateral organization in mixed protein–lipid films at air-aqueous interface can be studied by spectroscopic techniques and high resolution imaging techniques such as electron microscopy and atomic force microscopy (AFM) after transferring the films to a solid support. Using electron microscopy Cornell and Carroll found that only lipids with the chains in liquid state, e-PA, dioleoylphosphatidylcholine and dioleoylphosphatidylethanolamine, formed homogenous films with β -lactoglobulin, whereas DPPA and DSPC formed heterogeneous layers (Cornell and Carroll, 1985). AFM as powerful technique to study the lateral organization in mixed films of proteins and soluble surfactants have already been demonstrated with the development of the “orogenic” displacement model (Mackie et al., 1999; Mackie et al., 2001a; Mackie et al. 2001b). Diederich et al. studied the interaction between bacterial surface layer proteins (S-layer proteins) and phosphatidylethanolamine (DMPE and DPPE) monolayers using dual label fluorescence microscopy, FTIR spectroscopy, and electron microscopy (Diederich et al., 1996). When the monolayer is in the two-phase region, with one isotropic and one anisotropic fluid phase, the S-layer protein adsorbed preferentially to the isotropic phase. However, 2D crystallization could be nucleated in the boundaries between the two phases, but proceeded mainly underneath the anisotropic phase. The FTIR-measurements clearly indicate that the protein crystallization leads to an increased order of the lipid acyl chains.

5.5 Applications

Not only the composition of the interfacial layer, but also the mechanical properties, e.g., the dilational viscosity, of the layer is important for the stability of emulsions and foams (MacRitchie, 1990; Prins and Bergink-Martens, 1992; Dickinson, 1999; Bos and van Vliet, 2001b). In particular, both surface and bulk rheology as well as the disjoining pressure of the thin lamellae determine the stability of foams (Dickinson and Stainsby, 1982; Bos and van Vliet, 2001b). Hence, in technical applications thickeners are often added. The mechanical properties of interfacial films can to a large extent be controlled by the intermolecular interactions. Protein stabilization of a foam is mainly due to protein–protein interaction and the destabilization is thought of as a disruption of these interactions according to the Gibbs-Marangoni effect discussed above in the beginning of section 5.4.

5.5.1 Role of Protein-Emulsifier Interactions in Real Food (and Pharmaceutical) Systems

How the basic principles defined in section 5.4 come into play in some typical applications.

Sarker et al. (Sarker et al., 1995) discussed the effect of the surfactant properties on the stability of interfacial films in foams. The addition of small amount of lysophosphatidylcholine (LPC) was found to increase the foam stability of β -lactoglobulin foams (Sarker et al., 1995). A further increase of the surfactant concentration led to a decrease of the foam stability. The surface tension versus molar ratio of LPC and β -lactoglobulin show an inflection point close to unity molar ratio, corresponding to the binding of the surfactant to the protein. No increase of foam stability was, however, observed for mixtures of Tween 20 and β -lactoglobulin, instead the stability decreased with increasing surfactant concentration (Coke et al., 1990). The same observations was made for the stability of an oil-in-water emulsion, where it was found that small amount of Tween 20 increased the rate of shear induced coalescence of β -lactoglobulin stabilized emulsion droplets (Chen et al., 1993). The marked reduction in surface shear viscosity even at low surfactant to protein ratios confirmed that loosening of the protein layer occurred. The effects of LPC on interfacial rheology showed that at low surfactant to protein ratios, an enhancement in the surface elasticity was found (Gunning et al., 2004), which could explain the observed increase in foam stability. The protein-surfactant complex is thought of being less surface active and a further increase of the surfactant concentration will lead to replacement of protein and protein surfactant complexes with surfactant at the interface (Coke et al., 1990; Krägel et al., 1995). The mobility of the protein in a protein stabilized thin liquid film, as measured with the fluorescence recovery after photobleaching technique (FRAP), increases at lower surfactant to protein ratio for Tween 20 than for LPC (Fig. 5.19). This was attributed to the stronger binding of Tween 20, compared with LPC, to β -lactoglobulin (Sarker et al., 1995) and will also explain why the foam becomes unstable at lower surfactant concentration when Tween 20 is used. The foaming properties of puroindoline from wheat was also found to be improved by the addition of LPC (Wilde et al., 1993). Once the surfactant concentration becomes large enough, the protein-protein interactions within the surface film will be prevented, the mobility increased and thus the foam stability decreased according.

The lipid binding activity of puroindolines can be exploited to counteract the foam damaging effects of lipids. Lipid binding proteins can sequester lipids and prevent their adsorption and subsequent destabilizing of protein foams (Clark et al., 1994b). These proteins are common in cereals and may play a role in foam stability in baked products and beer.

Ionic surfactant can also induce flocculation of protein stabilized emulsions and this is depending on the nature of the protein-lipid interaction as discussed by Chen and Dickinson (Chen and Dickinson, 1995a; Chen and Dickinson, 1995b; Chen and Dickinson, 1995c). An anionic surfactant, sodium lauryl ether sulphate (SLES), at sufficient concentration has been found to flocculate gelatine stabilized oil-in-water

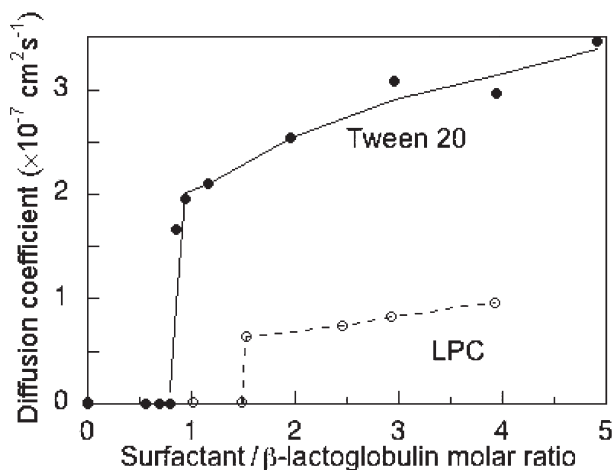

Fig. 5.19 The effect of surfactant addition on the lateral diffusion in the adsorbed mixed layer of surfactant and β -lactoglobulin, measured with the fluorescence recovery after photobleaching, FRAP, technique. The diffusion coefficients of the fluorescent probe 5-N-(octadecanoyl)amino fluorescein and fluorescein isothiocyanate isomer 1 labelled β -lactoglobulin measured in the presence of L- α -lysophosphatidylcholine (○) and Tween 20 (●), respectively, are shown as a function of the molar ratio between surfactant and β -lactoglobulin. The data are adapted from the work of Sarker et al. (1995) and Coke et al. (1990), respectively, in which the experimental details also are given









emulsion (Chen and Dickinson, 1995a). A further increase in surfactant concentration was found to lead to a restabilization of the flocculated emulsion. In bulk solution the anionic surfactant will, at high enough concentrations, cause precipitation of the positively charged gelatine. At a further increased surfactant concentration, the precipitate was redispersed. Gelatine was initially displaced by SLES from the interface (Chen and Dickinson, 1995c), but an increase of the surfactant concentration lead to an increase of gelatine concentration at the interface and the surface charge became partly neutralized (Chen and Dickinson, 1995b) causing flocculation. A further increase of the surfactant concentration lead to a decrease of the gelatine surface concentration (Chen and Dickinson, 1995c) and a restabilization of the emulsion (Chen and Dickinson, 1995a). It was also observed that the addition of SLES to a β -lactoglobulin stabilized emulsion not did cause any flocculation although some kind of complex was formed in bulk solution. It should be born in mind that β -lactoglobulin was negatively charged under the used experimental conditions. This confirms the electrostatic nature of the observed SLES induced flocculation of the emulsions stabilized by the positively charged gelatine. Flocculation of β -lactoglobulin stabilized emulsions was, however, observed in the presence of gelatine and SLES. Since it only occurred above the cmc of the surfactant it was suggested to depend on cross-linking of the emulsion droplets by surfactant micelles (Chen and Dickinson, 1995a).

Bylaite et al. found that emulsions with triglyceride oil generally proved to be more stable compared to those made with caraway essential oil as the dispersed phase (Bylaite

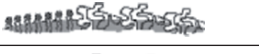
et al., 2001). However, the stability of the emulsions could be improved considerably by adding sb-PC. An increase in the protein concentration also promoted emulsion stability. Fang and Dalgeish arrived at a somewhat different conclusion for casein stabilized emulsions (Fang and Dalgeish, 1996). They found that the presence of DOPC destabilized casein stabilized emulsions of soybean oil in a 20-mM imidazole/HCl at pH 7.0. This seemed to be independent on whether DOPC was present during emulsification or if it was added to the emulsion as dispersed aggregates. At high concentration of casein, the emulsions were stable, and the decrease in surface load was a direct indication of the removal of casein from the interface by the presence of DOPC. The higher the DOPC concentration, the greater was the effect on emulsion stability and surface load. DPPC and egg PC either enhanced or did not affect the stability of the emulsion.

Waninge et al. (Waninge et al., 2005) studied the interaction between β -lactoglobulin and β -casein and milk membrane lipids at the oil-aqueous interface in emulsions. They found that the membrane lipid emulsified emulsions were dominated by the membrane lipids even after equilibrium with protein solutions. Protein displacement was not observed for β -lactoglobulin with time in contrast the displacement effects observed for the emulsions with β -casein, when both membrane lipids and β -casein were included during the emulsification. Based on results from three different types of emulsions, formed with different mixing order of the emulsifiers, they arrived on different alternative models that are described in Table 5.2. The eight different models can be divided into two main groups, where models I-III

Table 5.2 Models describing the oil–water surface with membrane lipids and β -casein/ β -lactoglobulin. Adapted from Waninge et al. (2005)

Model I: A mixed monolayer including both protein and membrane lipids.	
Model II: A mixed monolayer with strong specific interactions between the protein and the lipid.	
Model III: A lateral separated monolayer.	
Model IV: A protein layer adsorbed on top of the lipid layer.	
Model V: A lipid monolayer formed at a protein layer.	
Model VI: A lipid layer adsorbed on top of a protein layer.	
Model VII: Vesicular aggregates attached at the interfacial protein layer.	
Model VIII: Vesicular aggregates immersed into the interfacial protein layer.	

are independent of mixing order describing an equilibrium structure and models *IV* are dependent on mixing order describing and therefore represent nonequilibrium structures. Based on the results obtained from the serum depletion method Waninge et al. could estimate the surface composition at the oil–water interface.

Model *I-III* assumes a mixed monolayer, which is expected to correspond to a coverage of 2–2.5 mg/m². Significantly higher total adsorbed amount was observed when the emulsion was prepared in presence of both protein and lipid. Furthermore strong effect of the mixing order was observed, which exclude models *I-III*. A structure corresponding to model *IV* is the only possible explanation for adsorption of protein to a membrane lipid emulsified emulsion but it may also occur when both components are emulsified together. However, the low protein adsorption (up to about 0.3 mg/m²) observed when adding protein to the emulsion prepared in the presence of the lipid indicate a structure corresponding to model *IV*.

For both the β -casein and β -lactoglobulin emulsified emulsions significant amount of membrane lipids were observed (around 1.4 mg/m²) after adding the vesicles. Model *V*, *VI*, *VII* and *VIII* may describe the observed association between these emulsions and added membrane lipid vesicles. However, the pronounced hydrophilicity of the milk proteins makes a hydrophobic adhesion of a complete monolayer on top of the protein layer unlikely (Model *V*). The fact that lipid adsorption is observed without a corresponding desorption of protein excludes model *VIII*. Cryo-TEM images showed a few structures in agreement with model *VII*, but the frequency was too low to fully explain the association observed. Model *VI* can be a result of a transition from model *VII*, thus, a combination of model *VI* and *VII* seems to be the most likely structure in the system.

The observed gradual displacement of β -casein when emulsified together with the membrane lipids suggests the presence of the membrane lipid directly at the oil–water interface. Since the total adsorbed amount is well above monolayer coverage, model *VIII* appears more likely than model *III*. However, it can be assumed that the system gradually transforms from a structure of type *VIII* over to the more simple structure of type *III*.

The stable adsorbed layer when the emulsion is emulsified with both β -lactoglobulin and membrane lipids present suggests one of the structures *VI*, *VII* or *VIII*. However, model *VI* and *VII* seem more unlikely as the protein surface load is lower than the surface load of the pure protein emulsified emulsion. Notable is the absence of clear signs protein displacement. A possible explanation is that the protein layer is strongly crosslinked, as previously observed by (Chen and Dickinson, 1993; Chen et al., 1993; Mackie et al., 1999).

Several examples of how the properties of the oil phase composition can affect the structure of the adsorbed layer of protein on the emulsion droplet, and hence the stability of the emulsion, have been studied. For instance, the work of (Leaver and Dagleish, 1992) on the structure of adsorbed layers of β -casein on emulsion droplets, where it was found that the cleavage of the protein on the oil-droplet surface by trypsin gave different products depending on whether a triglyceride oil or tetradecane, was used. This demonstrates that the structure of the adsorbed layer depends on the composition of the oil.

5.5.2 Enzyme Activity and Protein/Emulsifier Application

What effect does the enzyme action have on the self-assembled emulsifier structure? How can lipase activity be affected by the presence of other proteins?

The action of lipolytic enzymes is of importance in a number of food applications or related areas, ranging from their use in detergents, as tools in modifying lipids to the breakdown of acylglycerides both as unwanted side effects and the naturally occurring process in the human intestine. It is well known that lipases work mainly at an interface and therefore one often speaks of “interfacial activation” in connection with lipase activity (Verger, 1997; Panaiotov and Verger, 2000). They are therefore an important example of lipid/protein interactions at interfaces. Lipases do play an important role in gastrointestinal tract for digestion of fat, (Patton and Carey, 1979), but they also have come to an increase use in industrial processes, including detergency and food processing (Svendsen, 2000).

Lipase act at such a low concentration that their presence as protein does not significantly affect the global lipid self-assembly structure. It is rather their catalytic activity that has an impact on the lipid self-assembly structure. It is also important to remember the action of lipases only decreases the time taken to reach the equilibrium and does not affect the equilibrium composition as such. Thus, the changes in structure in composition would have occurred even without the lipase if given enough time.

Here we will highlight some aspects in relation to the mechanisms of protein/lipid interactions. There are several types of lipases that act on phospholipids and triglycerides, but we will mainly discuss lipases catalyzing the hydrolysis of the ester bonds of triacylglycerols. The enzymatic activity is determined by the concentration of lipolytic enzymes associated with the lipid film and can be inhibited by various proteins (Gargouri et al. 1984a; Gargouri et al., 1984b). Experiments carried out with mixed protein/dicaprin films transferred over pure buffer yielded evidence that inhibition of hydrolysis was caused by proteins bound to the dicaprin film rather than by a direct interaction between protein and lipase in the bulk phase (Gargouri et al., 1985; Gargouri et al., 1986). Furthermore, since some lipases were inhibited by adsorption of proteins at the lipid layer, whereas other lipases were still able to hydrolyze a mixed protein/phospholipid layer, indicating that the inhibition of some lipases cannot be attributed merely to steric effects hindering accessibility to dicaprin molecules within the film. Surface concentration measurements of inhibitory proteins showed that only 5–9% of the area of a mixed lipid/protein film was covered by inhibitory proteins, implying that long-range electrostatic forces are likely to be involved in the inhibition as well as parameters such as surface viscosity and surface potential. However, similar inhibitory effects caused by melittin ($pI > 10$) and β -lactoglobulin A ($pI = 5.2$) at pH 8.0 strongly suggest that the nature of the inhibition is not an electrostatic phenomenon, but might be assigned to the effect on the properties of the hydrocarbon moiety of the lipid (Gargouri et al., 1987; Gargouri et al., 1989; Pièroni et al., 1990). The correlation between inhibition of lipase activity and the ability of the inhibitory protein to penetrate into the phospholipid monolayer support this suggestion.

In a simple experiment Wallin and Arnebrant demonstrated that a cubic phase was much faster decomposed by the action of lipase from *Thermomyces* (former *Humicola*)

lanuginosa than the reference sample consisting of triolein and aqueous phase (Wallin and Arnebrant, 1994). This was attributed to the much larger interfacial area in the cubic phase. In an *in vitro* study of lipolysis of triglycerides in a intestinal-like environment, Patton and Carey observed (Patton and Carey, 1979), apart from the initially occurring crystalline phase, a viscous isotropic phase composed of monoglycerides and fatty acids, which is identical to the one formed in monoglyceride systems. In excess of bile salts, the lipolysis products are rapidly solubilized in mixed micelles. However, the bile acid amounts *in vivo* are not sufficient to solubilize all lipids after a meal rich in fats, which implies that the liquid crystalline phases exist *in vivo* (Lindström et al., 1981). Lipase and water must be free to diffuse through the phases formed by the lipolysis products, surrounding the diminishing fat droplet. Thus, the bicontinuity as well as the incorporation properties of the cubic monoglyceride phases are thought to be important features for the lipolysis process (Patton et al., 1985). Borné et al. has in a series of studies investigate the affect of lipase action on liquid crystalline phase as well as other self-assemble structures such as vesicles and cubosomes (Borné et al., 2002a; Borné et al., 2002b; Caboi et al., 2002). Some of their findings are summarized in Fig. 5.20, which shows a schematic representation of the change in structure of the different liquid crystalline phases as a function of time after adding *Thermomyces lanuginosa* lipase. The observed changes in self-assembled structures could be predicted from either the monoolein–oleic acid–aqueous ternary phase diagram, where the lipolysis give rise to a transition of cubic → reversed hexagonal → micellar cubic → reversed micellar phase + dispersion or monoolein–sodium oleate–aqueous ternary phase diagram, where the corresponding sequence is lamellar → normal hexagonal. These difference in reaction sequences could be rationalized in terms of differences in degree of protonation of the fatty (Borné et al., 2002a). The initially lamellar phase had a high pH (about 10), that is a low degree of protonation and thus the degradation as expected follows monoolein–sodium oleate–aqueous ternary phase diagram. The initially cubic and hexagonal phase had low pH (4–7), that is a high degree of protonation and thus the degradation as expected follows the monoolein–oleic acid–aqueous ternary phase diagram. Adding *Thermomyces lanuginosa* lipase to aqueous dispersions of cubic phases (cubosomes) and lamellar dispersions (vesicles) at high water content and gave the corresponding morphological changes as for the liquid crystalline phases (Borné et al., 2002b). The phase diagrams of the relevant systems can thus be used as maps to navigate through the changes in the self-assembly structure of the substrate and the product. Borné et al. found similar specific activity of *Thermomyces lanuginosa* lipase on the cubic phase as on the reversed hexagonal monoolein based liquid crystalline phases, which was somewhat unexpected (Borné et al., 2002a).

5.5.3 New Products and Concepts of Using Protein/Emulsifier Interactions

Food nanotechnology and delivery of functionality.

The monoolein–aqueous system is thoroughly studied example of nanostructured system, where two types of cubic phases have been observed on the water-rich side

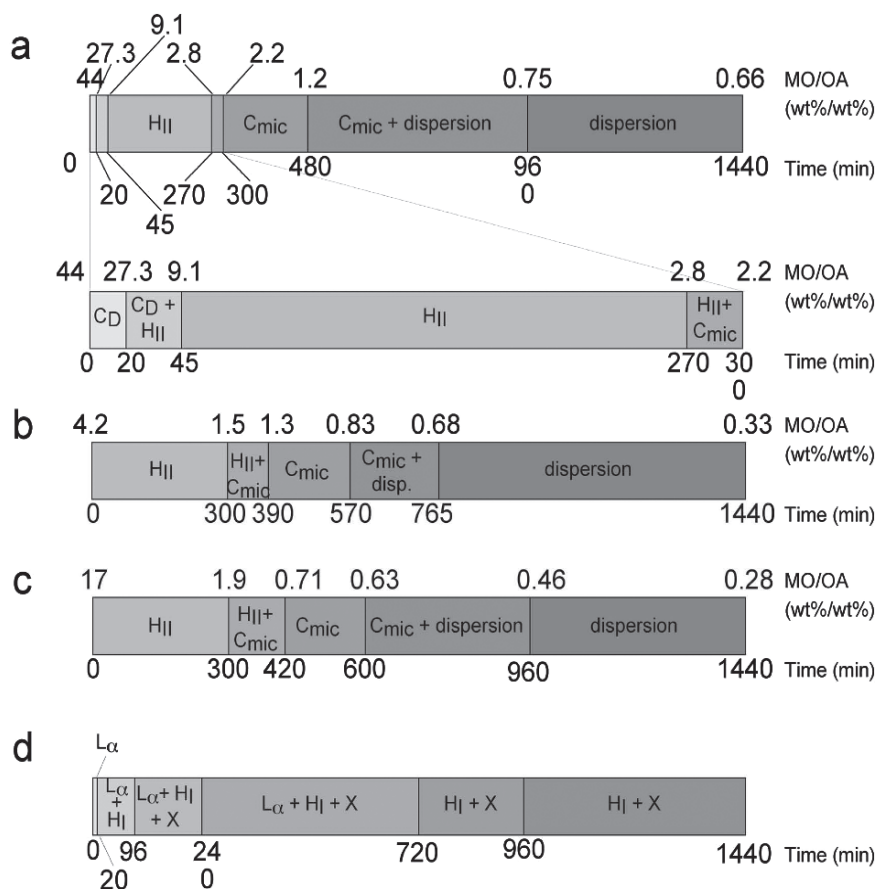

Fig. 5.20 Schematic representation of the change in structure during lipolysis of monoolein (MO) (or diolein DO) in different lc phases: **(a)** C_D phase (63 wt% MO, 37 wt% 2H_2O), **(b)** Oleic acid (OA)- H_{II} phase (65.4 wt% MO, 15.6 wt% OA, 19 wt% 2H_2O), **(c)** DO- H_{II} phase (68 wt% MO, 18 wt% DO, 14 wt% 2H_2O) and **(d)** L_α -phase (10 wt% MO, 5 wt% Sodium oleate (NaO), 85 wt% 2H_2O). The main liquid crystalline phases as determined by small angle X-ray diffraction (SAXD), are indicated in the figure as diamond type of bicontinuous cubic phase, space group $Pn3m$, (C_D), reversed hexagonal phase (H_{II}), normal hexagonal phase (H_I), lamellar phase (L_α) and micellar cubic phase, space group, $Fd3m$ (C_{mic}). These may exist in excess of water or in the presence of minor amounts of other phases. Some of the observed reflections in the diffractograms, obtained by SAXD, could not be unambiguously assigned to a structure. This unidentified structure is denoted X. Figure adapted from Borné et al. (2002a), where details are given

of the lamellar phase (Larsson, 1983; Hyde et al., 1984; Landh, 1994; Briggs et al., 1996; Qui and Caffrey, 2000). Here we will highlight some of the main features that are of importance for the functionality and application of lipid-based liquid crystalline cubic phases. First it is the bicontinuity of the cubic phase. This is illustrated

Fig. 5.21a and b, where the mobility of glucose solubilized in the aqueous channels and vitamin K₁, solubilized in the lipid bilayer, respectively is illustrated. Figure 5.21a shows the concentration profiles of glucose in the cubic monoolein-aqueous phase equilibrated against water as determined by holographic laser interferometry (Mattisson et al., 1996). These profiles could be fitted to Ficks 2nd law, which gave a diffusion coefficient 4 times lower than the value in aqueous solution. The mobility of the molecules in the aqueous channels of the cubic phase is certain to be affected by the dimensions of the channels and the size of the solute. Thus, electrochemical studies of the transport of cytochrome c in the monoolein-aqueous cubic phase gave values of diffusion coefficients that were about 70 times lower than the bulk values (Razumas et al., 1996a). Figure 5.21b shows the mobility of monoolein and vitamin K₁, dispersed in the lipid bilayer as the NMR self-diffusion coefficients plotted versus lipid volume fraction in the cubic phases. It is noteworthy that the mobility of the introduced vitamin K₁ follows that of monoolein, indicating complete dispersion of vitamin K₁.

The dimensions of the water channels in the bicontinuous cubic phases, which depend on the degree of swelling and type of cubic phase are in the same range as the size of proteins (cf., Barauskas et al., 2000). Furthermore, as liquid crystalline phases they are quite flexible structures. These features have triggered a number of studies, which have shown that a large range of hydrophilic proteins with molecular weights up to 590 kD can be entrapped in the aqueous cavity of the monoolein-aqueous cubic phases (Razumas et al., 1994; Leslie et al., 1996; Nylander et al., 1996; Razumas et al., 1996a; Razumas et al., 1996b; Barauskas et al., 2000). The entrapped proteins have been found to be protected in the cubic phase, with retained native confirmation (Ericsson et al., 1983b; Portmann et al., 1991; Landau and Luisi, 1993; Leslie et al., 1996; Razumas et al., 1996b) and some enzymes can be kept for a very long time (months in some cases), with retained activity, which is not possible in aqueous solution (Razumas et al., 1994; Nylander et al., 1996).

Spectroscopic data have revealed changes in the molecular organization of the lipids evoked by the presence of the protein. FT-IR measurements on the monoolein-cytochrome c aqueous system showed that the presence of cytochrome c increased the conformational order of the monoolein acyl chain and caused structural rearrangements in the polar head group region (Razumas et al., 1996a). These observations are in agreement with the decrease of the monoolein packing parameter on upon incorporation of cytochrome c, which was deduced from increase in unit cell dimension of the cubic phase as determined by small angle X-ray diffraction.

The cubic monoglyceride phases have also the ability to solubilize lipophilic proteins like A-gliadin from wheat (Larsson and Lindblom, 1982) and bacteriorhodopsin (Landau and Rosenbusch, 1996) as well as relatively large amounts of membrane lipids (Gutman et al., 1984; Nylander et al., 1996; Razumas et al., 1996b; Baruskas et al., 1999; Engblom et al., 2000) and other hydrophobic compounds of biological relevance (Caboi et al., 1997; Baruskas et al., 1999; Caboi et al., 2001). These compounds are most probably dispersed in the lipid bilayer region of the cubic phase. The cubic phases can be used to achieve unique delivery functionalities in food systems, e.g., to solubilize functional ingredients and nutrients and to control

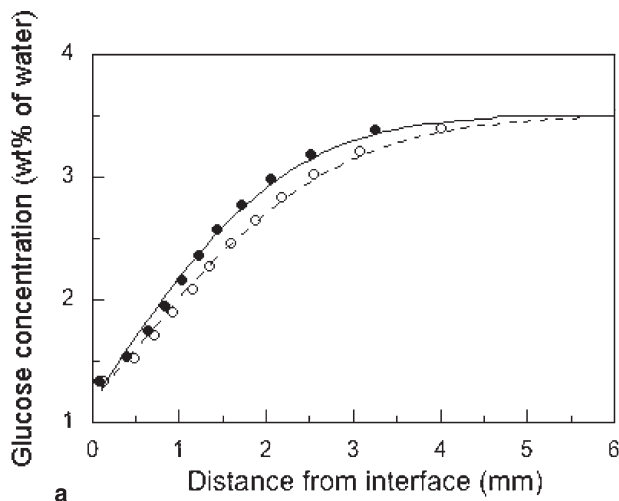

Fig. 5.21a Glucose concentration profiles in a monoolein- aqueous cubic phase (62:38 wt%), where the aqueous solution initially contained 3.5 wt% glucose, after 3 h (●) and 4 h (○) equilibration against pure water. The concentration is given as the wt% glucose in the aqueous solution of the cubic phase. The solid and broken lines are represent the best theoretical fit of Fick's law, giving diffusion coefficients of $1.39 \times 10^{-10} \text{ m}^2 \text{ s}^{-1}$ and $1.47 \times 10^{-10} \text{ m}^2 \text{ s}^{-1}$ after 3 and 4 h, respectively. The corresponding bulk value is $6.7 \times 10^{-10} \text{ m}^2 \text{ s}^{-1}$. The data, obtained by holographic laser interferometry, are adapted from Mattisson et al. (Mattisson, Nylander et al., 1996; Nylander, Mattisson et al., 1996), where also the experimental details are given

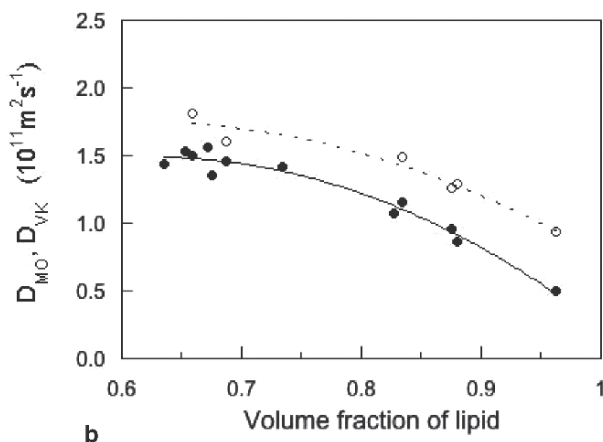

Fig. 5.21b NMR self-diffusion coefficients at 25 °C in monoolein-aqueous cubic phases containing 0–5 wt% vitamin K_1 , are shown as a function of the lipid volume fraction (including vitamin K_1). The self-diffusion coefficients were measured in the cubic (both gyroid and diamond type) and in the reversed micelle, L_2 , phases. Self-diffusion coefficients of monoolein (D_{MO}) (●) and vitamin K_1 (D_{VK}) (○) are shown. The lines are arbitrary fits to demonstrate the similar trends. The data are adapted from Caboi et al. (1997), where also the experimental details are given

release of flavors. Other applications in food systems can be to protect molecules from chemical degradation, or to increase the yield in Maillard reactions (Sagalowicz et al., 2006a).

Razumas et al. demonstrated that cubic monoolein-aqueous phases, containing enzymes, could be used as the biocatalytic layer in amperometric and potentiometric biosensors (Razumas et al., 1994). Their results for biosensors, based on a variety of enzymes, show that the long-term stability decreases in the order lactate oxidase > creatinine deiminase > glucose oxidase > urease, that is basically in the order of increasing molecular weight. Also the cubic phases of other amphiphiles like ethoxylated fatty alcohols can be used to entrap glucose oxidase, to construct a simple glucose monitor (Wallin et al., 1993). Landau and Rosenbusch demonstrated that the bicontinuous phases based on monoolein and monopalmitolein could provide matrices for the crystallization of membrane proteins like bacteriorhodopsin (Landau and Rosenbusch, 1996). They pointed out that the use of these types of cubic phase is advantageous as they provide nucleation sites, as the membrane proteins can be dissolved in the lipid bilayer. In addition they support growth by allowing lateral diffusion of the protein molecules in the membrane.

The bicontinuous cubic structures have by virtue of their well defined porosity also a large potential in drug delivery systems (Larsson, 1994). Stable particles of lipid-aqueous cubic phases, Cubosome[®] particles, can also be produced for this purpose (Larsson, 1989; Landh, 1994; Larsson, 1994; Gustafsson et al., 1996; Gustafsson et al., 1997; Larsson, 2000). The stability of Cubosome[®] particles, formed in monoolein-H₂O-based systems, and the corresponding dispersed H_{II} phase (Hexosome[®] particles) in the monoolein-triolein-H₂O system was found to increase in the presence of an amphiphilic block-copolymer (polyoxamer) (Landh, 1994; Gustafsson et al., 1996; Gustafsson et al., 1997). Barauskas et al. have devised a method to prepare very monodispersed Cubosome particles[®] and they found it was possible to further controlling dispersion particle size and nanostructure by varying the amphiphile concentration, the amount of charged species, and salt content (Barauskas et al., 2005a). In fact they showed that it is possible to prepare a range of different nanoparticle dispersions of self-assembled lipid mesophases with distinctive reversed cubic, hexagonal, and sponge phase structures by tuning the lipid composition and a simple, generally applicable and scalable method (Barauskas et al., 2005b). Some of these structures are shown in Fig. 5.22. A strong correlation between the mesophase internal structure and the shape of the nanoparticles was observed. For example, monocrystalline cubic-phase nanoparticles tend to maintain the shape of the cube, hexagonal phase give the shape of a hexanon, while the highly disordered “sponge” phase structures, favor the spherical shape. Guillot et al. (2006) identified possible internally self-assembled phases that occur in oil-loaded monoglyceride-based nanoparticles that are dispersed in water. The internal structure of these particles could be change by changing the temperature transforming from hexosomes to emulsified microemulsions through micellar cubosomes (emulsified reversed discontinuous micellar cubic phase) within a narrow range of an oil/monoglycerides ratio.

Several studies on different type of dispersed liquid-crystalline nanoparticles (LCNP) have pointed on the potential of using these systems for drug delivery as

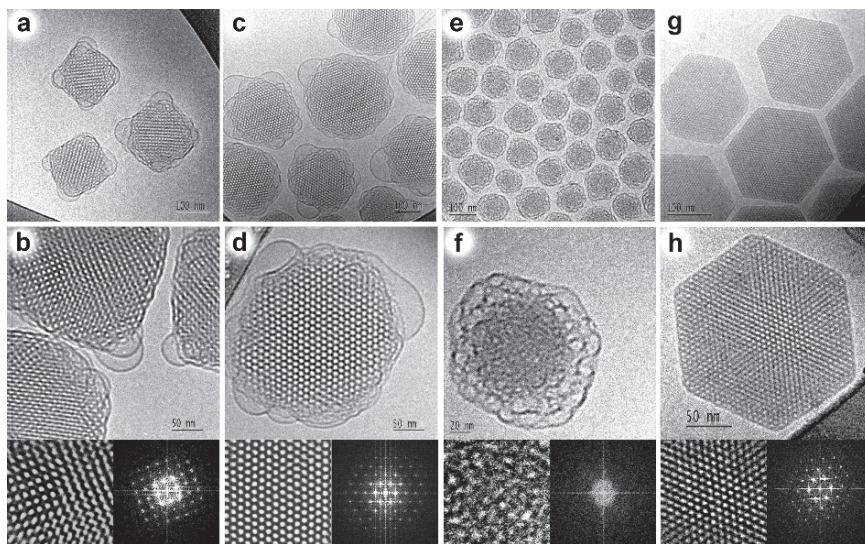

Fig. 5.22 Representative cryo-TEM micrographs of different nonlamellar lipid nanoparticles: Reversed bicontinuous cubic phase particles viewed along [001] (**a** and **b**) and [111] (**c** and **d**) directions. These dispersions were prepared at the weight ratio GMO/ F127/water) 1.88/0.12/98.0. Panels **e** and **f**: Monodisperse “sponge” phase nanoparticles prepared at the weight ratio DGMO/ GDO/P80/water) 2.13/2.13/0.74/95.0 (**e** and **f**). Reversed hexagonal monocrystalline particles made of lipids at the weight ratio DGMO/ GDO/F127/water) 2.25/2.25/0.5/95.0 (**g** and **h**). Fourier transforms of magnified areas in panels **b**, **d**, **f**, and **h** show the structural periodicity of the different nanoparticles consistent with the mesophase structures indicated above. The picture is kindly provided by Justas Barauskas and further details are in Barauskas et al. (2005b)

well as delivery of functionality to foods (Barauskas et al., 2005a; Barauskas et al., 2005b; Esposito et al., 2005; Spicer, 2005a; Spicer, 2005b; Almgren and Rangelov, 2006; Angelov et al., 2006; Barauskas et al., 2006a; Barauskas et al., 2006b; Boyd et al., 2006; Johnsson et al., 2006; Sagalowicz et al., 2006a; Sagalowicz et al., 2006b; Tamayo-Esquivel et al., 2006; Vandoolaeghe et al., 2006; Worle et al., 2006; Yaghmur et al., 2006). This has been shown, with both model and in vivo studies for the drug substance propofol; a well-known anesthetic agent currently used in clinical practice in the form of a stable emulsion (Johnsson et al., 2006). The propofol-LCNP formulation shows several useful features including: higher drug-loading capacity, lower fat-load, excellent stability, modified pharmacokinetics, and an indication of increased effect duration.

An interesting aspect of the interaction between liquid crystalline phases and proteins is the study of Angelova et al. (Angelova et al., 2005; Angelov et al., 2006). They showed that supramolecular three-dimensional self-assembly of nonlamellar lipids with fragments of the protein immunoglobulin gave bicontinuous cubic phase fragmented into nanoparticles with open water channels. These

so-called proteocubosomes are nanostructured open-nanochannel hierarchical fluid vehicles characterized by a cubic lattice periodicity of the lipid/protein supramolecular assembly (protein-loaded cubosomes).

5.6 Conclusion

The interaction between emulsifiers and proteins is to a large extent driven by electrostatic or hydrophobic interactions, or in many cases it is a combination of the two. Thus, it is commonly observed that ionic emulsifiers interact more strongly with proteins than nonionic ones. For emulsifiers with low water solubility, e.g., polar lipids, the interaction with proteins is largely dependent on the phase structure upon addition. The binding can, depending on the type of emulsifier, lead to stabilization of the protein structure at low-surfactant-to-protein ratios. However, an increase in surfactant concentration can induce unfolding of the protein and in some cases precipitation of the protein.

We have seen that the stability of emulsions and foams is determined by interfacial processes, which are affected by the properties of the interface as well as the interactions occurring in bulk solution. When no emulsifier/protein interactions are present, the composition of the interfacial film is determined by only the surface activity and concentration of the components. In the case of reversibility the most surface-active and/or abundant molecule dominates the interface and in the case of irreversibility the transport rate “the race for the interface” might also play a role. In this context it has to be born in mind that proteins can change their conformations (sometimes in a time-dependent way) at the interface. This may lead to a strong interaction between the protein and the surface, and multiple interactions between neighboring protein molecules. The latter has been found to hamper the displacement of a protein by more surface-active emulsifiers.

The presence of protein/emulsifier interactions can have pronounced impact on the interfacial behavior of the components. In cases where the emulsifier binding induces protein unfolding, exposure of hydrophobic domains of the protein, or precipitation at the interface due to charge neutralization, the surface activity of the complex is increased compared to the native protein. On the other hand, if the protein is more soluble or stabilized by the emulsifier interaction, the complex has a reduced tendency to adsorb at the interface. Precipitation of the complex in the bulk can cause loss of surface-active material and hence a decrease of the surface concentration. The emulsifier/protein interactions at interfaces can give more efficient packing and thus a higher total surface concentration. If protein/protein interactions take place at the interface, they may be disrupted by protein/emulsifier interactions.

Although emulsions and foams are stabilized by the same mechanisms, there are marked differences. First, there are profound differences between the two types of liquid interfaces: the liquid/air and the one between two condensed media. The oil/aqueous interface allows hydrophobic residues to become dissolved in and interact favorably with the oil phase, which is not possible at the air/water interface. It should

be noted that unfolding of the protein induced by action of emulsifiers or by the presence of an interface generally leads to exposure of hydrophobic residues; that is, the unfolded protein is more “oil soluble” than the native one. Second, in the stabilization of foams the viscoelastic properties of the surface film as well as the thin aqueous film have large effects. This means that protein/protein interactions in protein-stabilized foams are important, and the addition of surfactants can disrupt these interactions and lead to the collapse of the foam. On the other hand, low molecular weight emulsifiers can also stabilize the foam by means of Gibbs and Marangoni effects.

Steric and/or repulsive forces are important for stabilization of emulsions. Therefore, the mixed-protein/emulsifier layer should be optimized with respect to charge and/or by segments in the surface layer protruding into the aqueous environment to give a hairy structure that will sterically stabilize the emulsion.

This chapter has shown the enormous variety in emulsifier/protein interactions that can occur in food emulsions and foams. Each protein/emulsifier combination is unique and its behavior specific when applied in a particular foam or emulsion, where other ingredients are present. However, we have demonstrated that it is possible to establish certain principles for protein/emulsifier interactions. These principles based on mechanisms at the molecular level have also to be transferred to processes of manufacturing, storage, and distribution of food products based on emulsions and foams. Apart from the stability issues, other challenges are to increase the resistance of microbial growth without excessive use of antimicrobial substances, control digestion of the product, achieve controlled release of flavors as well as design new functional ingredients based on natural products.

References

- Ahlers, M., W. Müller, et al. (1990). Specific interactions of proteins with functional lipid monolayers—ways of simulating biomembrane process. *Angew. Chem. Int. Ed. Engl.*, 29, 1269–1285.
- Almgren, M. and S. Rangelov (2006). Polymorph dispersed particles from the bicontinuous cubic phase of glycerol monooleate stabilized by PEG-copolymers with lipid-mimetic hydrophobic anchors. *J. Dispersion Sci. Technol.*, 27, 599–609.
- Ananthapadmanabhan, K. P. (1993). Protein-Surfactant Interactions. *Interactions of Surfactants with Polymers and Proteins*. K. P. Ananthapadmanabhan and E. D. Goddard (Eds.) Boca Raton; Florida, CRC Press, pp. 319–366.
- Andersson, S., S. T. Hyde, et al. (1988). Minimal surfaces and structures: From inorganic and metal crystals to cell membranes and biopolymers. *Chem. Rev.*, 88, 221–242.
- Angelov, B., A. Angelova, et al. (2006). Detailed structure of diamond-type lipid cubic nanoparticles. *J. Am. Chem. Soc.*, 128, 5813–5817.
- Angelova, A., B. Angelov, et al. (2005). Proteocubosomes: Nanoporous vehicles with tertiary organized fluid interfaces. *Langmuir*, 21, 4138–4143.
- Aynié, S., M. Le Meste, et al. (1992). Interactions between lipids and milk proteins in emulsion. *J. Food Sci.*, 57, 883–887.
- Backstrom, K., B. Lindman, et al. (1988). Removal of triglycerides from polymer surface in relation to surfactant packing—ellipsometer studies. *Langmuir*, 4, 872–878.
- Barauskas, J., M. Johnsson, et al. (2005a). Cubic phase nanoparticles (cubosome): Principles for controlling size, structure, and stability. *Langmuir*, 21, 2569–2577.

- Barauskas, J., M. Johnsson, et al. (2005b). Self-assembled lipid superstructures: Beyond vesicles and liposomes. *Nano Lett.*, 5, 1615–1619.
- Barauskas, J., M. Johnsson, et al. (2006a). Hexagonal liquid-crystalline nanoparticles in aqueous mixtures of glyceryl monooleyl ether and pluronic F127. *Chem. Lett.*, 35, 830–831.
- Barauskas, J., A. Misiunas, et al. (2006b). “Sponge” nanoparticle dispersions in aqueous mixtures of diglycerol monooleate, glycerol dioleate, and polysorbate 80. *Langmuir*, 22, 6328–6334.
- Baruskas, J., V. Razumas, et al. (1999). Solubilization of ubiquinone-10 in the lamellar and bicontinuous cubic phases of aqueous monoolein. *Chem. Phys. Lipids*, 97, 167–179.
- Barauskas, J., V. Razumas, et al. (2000). Entrapment of glucose oxidase into the cubic Q230 and Q224 phases of aqueous monoolein. *Prog. Colloid Polym. Sci.*, 116, 16–20.
- Benichou, A., A. Aserin, et al. (2002). Protein-polysaccharide interactions for stabilization of food emulsions. *J. Dispersion Sci. Technol.*, 23, 93–123.
- Biswas, S. C. and D. Marion (2006). Interaction between puroindolines and the major polar lipids of wheat seed endosperm at the air-water interface. *Colloids Surf. B Biointerfaces*, 53, 167–174.
- Blomqvist, B. R., M. J. Ridout, et al. (2004). Disruption of viscoelastic beta-lactoglobulin surface layers at the air-water interface by nonionic polymeric surfactants. *Langmuir*, 20, 10150–10158.
- Blomqvist, B. R., P. Wilde, et al. (2006). Competitive destabilization/stabilization of beta-lactoglobulin foam by PEO-PPO-PEO polymeric surfactants. *J. Dispersion Sci. Technol.*, 27, 527–536.
- Bohnert, J. L. and T. A. Horbett (1986). Change in adsorbed fibrinogen and albumin interactions with polymers indicated by decrease in detergent elutability. *J. Colloid Interface Sci.*, 111, 363–378.
- Borné, J., T. Nylander, et al. (2001). Phase behavior and aggregate formation for the aqueous monoolein system mixed with sodium oleate and oleic acid. *Langmuir*, 17, 7742–7751.
- Borné, J., T. Nylander, et al. (2002a). Effect of lipase on different lipid liquid crystalline phases formed by oleic acid based acyl glycerols in aqueous systems. *Langmuir*, 18, 8972–8981.
- Borné, J., T. Nylander, et al. (2002b). Effect of lipase on monoolein-based cubic phase dispersion (cubosomes) and vesicles. *J. Phys. Chem. B*, 106, 10492–10500.
- Bos, M. and T. Nylander (1996). The interaction between beta-lactoglobulin and phospholipids at the air/water interface. *Langmuir*, 12, 2791–2797.
- Bos, M., T. Nylander, et al. (1997). Protein/emulsifier interactions. *Food emulsifiers and their applications*. G. L. Hasenhuettl and R. W. Hartel. New York, Chapman and Hall, pp. 95–146.
- Bos, M. A. and T. van Vliet (2001a). Interfacial rheological properties of adsorbed protein layers and surfactants: a review. *Adv. Colloid Interface Sci.*, 91, 437–471.
- Bos, M. A. and T. van Vliet (2001b). Interfacial rheological properties of adsorbed protein layers and surfactants: a review. *Adv. Colloid Interface Sci.*, 91, 437–471.
- Boström, M., D. R. M. Williams, et al. (2002). Influence of Hofmeister effects on surface pH and binding of peptides to membranes. *Langmuir*, 18, 8609–8615.
- Boström, M., D. R. M. Williams, et al. (2001). Specific ion effects: Why DLVO theory fails for biology and colloid systems. *Phys. Rev. Lett.*, 87, 168103.
- Boyd, B. J., D. V. Whittaker, et al. (2006). Hexosomes formed from glycerate surfactants—Formulation as a colloidal carrier for irinotecan. *Int. J. Pharm.*, 318, 154–162.
- Brash, J. L. and P. Hove (1984). Effect of plasma dilution on adsorption of fibrinogen to solid surfaces. *Thromb. Haemost.*, 51, 326–330.
- Briggs, J., H. Chung, et al. (1996). The temperature-composition phase diagram and mesophase structure characterization of the monoolein/water system. *J. Phys. II France*, 6, 723–751.
- Brooksbank, D. V., J. Leaver, et al. (1993). Adsorption of milk proteins to phosphatidylglycerol and phosphatidylcholine liposomes. *J. Colloid Interface Sci.*, 161, 38–42.
- Brown, E. M. (1984). Interactions of beta-lactoglobulin with lipids: A review. *J. Dairy Sci.*, 67, 713–722.

- Brown, E. M., R. J. Carroll, et al. (1983). Complex formation in sonicated mixtures of b-lactoglobulin and phosphatidylcholine. *Lipids*, 18, 111–118.
- Buckingham, J. H., J. Lucassen, et al. (1978). Surface properties of mixed solutions of poly-L-lysine and sodium dodecyl sulfate. *J. Colloid Interface Sci.*, 67, 423–431.
- Bychokova, V. E., R. H. Pain, et al. (1988). The 'molten globule' state is involved in the translocation across membranes? *FEBS Lett.*, 238, 231–234.
- Bylaite, E., T. Nylander, et al. (2001). Emulsification of caraway essential oil in water by lecithin and b-lactoglobulin—emulsion stability and properties of the formed oil-aqueous interface. *Colloids Surf. B Biointerfaces*, 20, 327–340.
- Caboi, F., G. S. Amico, et al. (2001). Addition of hydrophilic and lipophilic compounds of biological relevance to the monoolein: Water system. I. Phase behavior. *Chem. Phys. Lipids*, 109, 47–62.
- Caboi, F., J. Borné, et al. (2002). Lipase action on a monoolein/sodium oleate aqueous cubic liquid crystalline phase - a NMR and X-ray diffraction study. *Colloids Surf. B Biointerfaces*, 26, 159–171.
- Caboi, F., T. Nylander, et al. (1997). Structural effects, mobility and redox behavior of Vitamin K1 hosted in the monoolein-water liquid crystalline phases. *Langmuir*, 13, 5476–5483.
- Carlsson, A., M. Bergqvist, et al. (1995). Digalactosyldiacylglycerol—a new excipient in drug formulation. *Progress in Drug Delivery System IV, Biomedical Research Foundation*, Tokyo 105–115.
- Castle, J., E. Dickinson, et al. (1987). Mixed-protein films adsorbed at the oil-water interface. *ACS Symp. Ser.*, 343, 118–134.
- Chen, J. and E. Dickinson (1993). Time-dependent competitive adsorption of milk proteins and surfactants in oil-in-water emulsions. *J. Sci. Food Agric.*, 62, 283–289.
- Chen, J. and E. Dickinson (1995a). Protein/surfactant interactions Part 1. Flocculation of emulsions containing mixed protein + surfactant. *Colloids Surfaces A: Physicochem. Eng. Aspects*, 100, 255–265.
- Chen, J. and E. Dickinson (1995b). Protein/surfactant interactions Part 2. Electrophoretic mobility of mixed protein + surfactant systems. *Colloids Surfaces A: Physicochem. Eng. Aspects*, 100, 267–277.
- Chen, J. and E. Dickinson (1995c). Protein/surfactant interfacial interactions. Part 3. Competitive adsorption of protein + surfactant in emulsions. *Colloids Surfaces A: Physicochem. Eng. Aspects*, 101, 77–85.
- Chen, J., E. Dickinson, et al. (1993). Interfacial interactions, competitive adsorption and emulsion stability. *Food Struct.*, 12, 135–146.
- Chupin, V., J. A. Killian, et al. (1987). ²H-Nuclear magnetic resonance investigations on phospholipid acyl chain order and dynamics in the gramicidin-induced hexagonal H_{II} phase. *Biophys. J.*, 51, 395–405.
- Clark, D. C. (1995). Application of state-of-the-art fluorescence and interferometric technique to study coalescence in food dispersions. *Characterisation of Food: Emerging Methods*. A. Goankar. Amsterdam, Elsevier, pp. 23–57.
- Clark, D. C., M. Coke, et al. (1990a). Molecular-diffusion and thickness measurements of protein-stabilized thin liquid-films. *J. Colloid Interface Sci.*, 138, 207–219.
- Clark, D. C., M. Coke, et al. (1991a). Molecular diffusion at interfaces and its relation to dispersed phase stability. *Food, Polymers, Gels and Colloids*. E. Dickinson. London, Royal Society of Chemistry, pp. 272–278.
- Clark, D. C., R. Dann, et al. (1990b). Surface-diffusion in sodium dodecyl sulfate-stabilized thin liquid-films. *J. Colloid Interface Sci.*, 138, 195–206.
- Clark, D. C., F. Husband, et al. (1995). Evidence of extraneous surfactant adsorption altering adsorbed layer properties of b-lactoglobulin. *J. Chem. Soc. Faraday Trans.*, 91, 1991–1996.
- Clark, D. C., A. R. Mackie, et al. (1994a). Differences in the structure and dynamics of the adsorbed layers in protein stabilized model foams and emulsions. *Faraday Discuss.*, 98, 253–262.
- Clark, D. C., P. J. Wilde, et al. (1991b). Destabilization of α -lactalbumin foams by competitive adsorption of the surfactant Tween 20. *Colloids Surf.*, 59, 209–223.

- Clark, D. C., P. J. Wilde, et al. (1992). The interaction of sucrose esters with b-lactoglobulin and b-casein from bovine milk. *Food Hydrocolloids*, 6, 173–186.
- Clark, D. C., P. J. Wilde, et al. (1993). Differences in the structure and dynamics of the adsorbed layers in protein stabilised model foams and emulsions. *Food Colloids and Polymers: Structure and Dynamics*. E. Dickinson and P. Walstra. Cambridge, Royal Society of Chemistry Special Publication No. 113, pp. 354–364.
- Clark, D. C., P. J. Wilde, et al. (1994b). The protection of beer foam against lipid-induced destabilization. *J. Inst. Brew.*, 100, 23–25.
- Coke, M., P. J. Wilde, et al. (1990). The influence of surface composition and molecular diffusion on the stability of foams formed from protein/surfactant mixtures. *J. Colloid Interface Sci.*, 138, 489–504.
- Cordoba, J., M. D. Reboiras, et al. (1988). Interaction of n-octyl-b-D-glucopyranoside with globular proteins in aqueous solution. *Int. J. Biol. Macromol.*, 10, 270–276.
- Corkery, R. W. (2002). The anti-parallel, extended or splayed-chain conformation of amphiphilic lipids. *Colloids Surf. B Biointerfaces*, 26, 3–20.
- Cornell, D. G. (1982). Lipid-protein interactions in monolayers: Egg yolk phosphatidic acid and b-lactoglobulin. *J. Colloid Interface Sci.*, 88, 536–545.
- Cornell, D. G. and R. J. Carroll (1985). Miscibility in lipid-protein monolayers. *J. Colloid Interface Sci.*, 108, 226–233.
- Cornell, D. G. and D. L. Patterson (1989). Interaction of phospholipids in monolayers with b-lactoglobulin adsorbed from solution. *J. Agric. Food Chem.*, 37, 1455–1459.
- Cornell, D. G., D. L. Patterson, et al. (1990). The interaction of phospholipids in monolayers with bovine serum albumin and a-lactalbumin adsorbed from solution. *J. Colloid Interface Sci.*, 140, 428–435.
- Courthaudon, J. L., E. Dickinson, et al. (1991). Competitive adsorption of lecithin and b-casein in oil-in-water emulsions. *J. Agric. Food Chem.*, 39, 1365–1368.
- Cowley, A. C., N. L. Fuller, et al. (1978). Measurements of repulsive forces between charged phospholipid bilayers. *Biochemistry*, 17, 3163–3168.
- Creighton, T. E. (1990). Protein folding. *Biochem. J.*, 270, 1–16.
- Creighton, T. E. (1993). *Proteins — Structure and Molecular Properties*. New York, W. H. Freeman.
- Danthine, S., C. Blecker, et al. (2000). Progress in milk fat globule membrane research: a review. *Lait*, 80, 209–222.
- De Kruijff, B. (1997). Lipid polymorphism and biomembrane function. *Curr. Opin. Colloid Interface Sci.*, 1, 564–569.
- De Kruijff, B. and P. R. Cullis (1980). Cytochrome c specifically induces non-bilayer structures in cardiolipin containing model membranes. *Biochim. Biophys. Acta*, 602, 477–490.
- de Wit, J. N. (1989). Functional properties of whey proteins. *Developments in Dairy Chemistry - 4*. P. F. Fox. London, Elsevier Applied Science, pp. 285–322.
- Dickinson, E. (1993). Proteins in solution and at interfaces. *Interactions of Surfactants with Polymers and Proteins*. K. P. Ananthapadmanabhan and E. D. Goddard (Eds.) Boca Raton; Florida, CRC Press, pp. 295–317.
- Dickinson, E. (1996). Biopolymer interactions in emulsion systems: Influences on creaming, flocculation, and rheology. *Macromolecular Interactions in Food Technology*. Washington DC, American Chemical Society. 650, pp. 197–207.
- Dickinson, E. (1999). Adsorbed protein layers at fluid interfaces: Interactions, structure and surface rheology. *Colloids Surf. B Biointerfaces*, 15, 161–176.
- Dickinson, E. (2003). Hydrocolloids at interfaces and the influence on the properties of dispersed systems. *Food Hydrocolloids*, 17, 25–39.
- Dickinson, E. and G. Iveson (1993). Adsorbed films of b-lactoglobulin + lecithin at the hydrocarbon-water and triglyceride-water interfaces. *Food Hydrocoll.*, 6, 533–541.
- Dickinson, E. and Y. Matsumura (1991). Time-dependent polymerization of b-lactoglobulin through disulphide bonds at the oil-water interface in emulsions. *Int. J. Biol. Macromol.*, 13, 26–30.
- Dickinson, E. and Y. Matsumura (1994). Proteins at liquid interfaces: role of the molten globule state. *Colloids Surf. B Biointerfaces*, 3, 1–17.

- Dickinson, E. and G. Stainsby (1982). *Colloids in Food*. London, Applied Science Publishers.
- Dickinson, E. D. and C. M. Woskett (1989). Competitive adsorption between proteins and small molecular surfactants in food emulsions. *Food and Colloids*. R. D. Bee, P. Richmond and J. Mings (Eds.) London, Royal Society of Chemistry, pp. 74–96.
- Diederich, A., C. Sponer, et al. (1996). Reciprocal influence between the protein and lipid components of a lipid-protein membrane model. *Colloids Surf. B Biointerfaces*, 6, 335–346.
- Dill, K. A. (1990). Dominant forces in protein folding. *Biochemistry*, 29, 7133–7155.
- Dolgikh, D. A., L. V. Abaturov, et al. (1985). Compact state of a protein molecule with pronounced small-scale mobility: bovine α -lactalbumin. *Eur. Biophys. J.*, 13, 109–121.
- Dolgikh, D. A., R. I. Gilmanshin, et al. (1981). α -Lactalbumin: Compact state with fluctuating tertiary structure? *FEBS Lett.*, 136, 311–315.
- Du, Y.-K., J.-Y. An, et al. (1996). A study of the interaction between glucolipids of different hydrophobicities and glucos oxidase by a monolayer technique. *Colloid Surf. B Biointerfaces*, 7, 129–133.
- Dubreil, L., J. P. Compoin, et al. (1997). Interaction of puroindolines with wheat flour polar lipids determines their foaming properties. *J. Agric. Food Chem.*, 45, 108–116.
- Elwing, H., A. Askendal, et al. (1989). Desorption of fibrinogen and γ -globulin from solid surface induced by a nonionic detergent. *J. Colloid Interface Sci.*, 128, 296–300.
- Elwing, H. and C. G. Golander (1990). Protein and detergent interaction phenomena on solid surface with gradients in chemical composition. *Adv. Colloid Interface Sci.*, 32, 317–339.
- Engblom, J., Y. Miezi, et al. (2000). On the swelling of monoolein liquid-crystalline aqueous phases in the presence of distearoylphosphatidylglycerol. *Prog. Colloid Polym. Sci.*, 116, 9–15.
- Engel, M. F. M., C. P. M. van Mierlo, et al. (2002). Kinetic and Structural Characterization of Adsorption-induced Unfolding of Bovine α -Lactalbumin. *J. Biol. Chem.*, 277, 10922–10930.
- Ericsson, B. (1986). Interactions between globular proteins and lipids. *Food Technology*. Lund, Sweden, University of Lund: 65.
- Ericsson, B. and P.-O. Hegg (1985). Surface behaviour of adsorbed films from protein-amphiphile mixtures. *Prog. Colloid Polym. Sci.*, 70, 92–95.
- Ericsson, B., P.-O. Hegg, et al. (1983a). Protection of ovalbumin against irreversible heat denaturation by cationic amphiphile at high concentration. *J. Food Technol.*, 18, 11–19.
- Ericsson, B., P.-O. Hegg, et al. (1987a). Effect on cationic amphiphiles and temperature on lysosome conformation. *J. Dispersion Sci. Technol.*, 8, 271–287.
- Ericsson, B., P.-O. Hegg, et al. (1987b). Effects of amphiphiles on trypsin activity and conformation. *J. Dispersion Sci. Technol.*, 8, 289–301.
- Ericsson, B., K. Larsson, et al. (1983b). A cubic protein-monoolein-water phase. *Biochim. Biophys. Acta*, 729, 23–27.
- Esposito, E., R. Cortesi, et al. (2005). Cubosome dispersions as delivery systems for percutaneous administration of indomethacin. *Pharm. Res.*, 22, 2163–2173.
- Evans, D. F., M. Allen, et al. (1984a). Critical micelle concentrations for alkyltrimethylammonium bromides in water from 25 to 160 °C. *J. Sol. Chem.*, 13, 87–101.
- Evans, D. F., D. J. Mitchell, et al. (1984b). Ion binding and dressed micelles. *J. Phys. Chem.*, 88, 6344–6348.
- Ewers, W. E. and K. L. Sutherland (1952). The role of surface transport in the stability and breakdown of foams. *Aust. J. Sci. Res. Ser.*, A5, 697–710.
- Fainerman, V. B., E. H. Lucassen-Reynders, et al. (1998). Adsorption of surfactants and proteins at fluid interfaces. *Colloids Surfaces A: Physicochem. Eng. Aspects*, 143, 141–165.
- Fang, Y. and D. G. Dalgleish, 73, 437–442 (1996). Comparison of the effects of three different phosphatidylcholines on casein-stabilized oil-in-water emulsions. *J. Am. Oil Chem. Soc.*, 73, 437–442.
- Flockhart, B. D. (1961). The effect of temperature on the critical micelle concentration of some paraffin-chain salts. *J. Colloid Interface Sci.*, 16, 484–492.
- Fontell, K. (1990). Cubic phases in surfactant and surfactant-like lipid systems. *Colloid Polym. Sci.*, 268, 264–285.
- Fontell, K. (1992). Some aspects on the cubic phases in surfactant and surfactant-like lipid systems. *Adv. Colloid Interface Sci.*, 41, 127–147.

- Frapin, D., E. Dufour, et al. (1993). Probing fatty acid binding site of β -lactoglobulin. *J. Protein Chem.*, 12, 443–448.
- Fraser, P. E., R. P. Rand, et al. (1989). Bilayer-stabilising properties of myelin basic protein in dioleoylphosphatidylethanolamine systems. *Biochim. Biophys. Acta*, 983, 23–29.
- Friberg, S. (1971). Liquid crystalline phases in emulsions. *J. Colloid Interface Sci.*, 37, 291–295.
- Friberg, S., L. Mandell, et al. (1969). Mesomorphous phases a factor of importance for properties of emulsions. *J. Colloid Interface Sci.*, 29, 155–161.
- Frøberg, J. C., E. Blomberg, et al. (1999). Desorption of lysozyme layers by sodium dodecyl sulfate studied with the surface force technique. *Langmuir*, 15, 1410–1417.
- Fukushima, K., Y. Murata, et al. (1981). The binding of sodium dodecyl sulfate to lysozyme in aqueous solution. *Bull. Chem. Soc. Jpn.*, 54, 3122–3127.
- Fukushima, K., Y. Murata, et al. (1982). The binding of sodium dodecylsulfate to lysozyme in aqueous solution. II. The effect of added NaCl. *Bull. Chem. Soc. Jpn.*, 55, 1376–1378.
- García Domínguez, J. J., R. Infante, et al. (1981). Interaction alkylsulphates-proteins and their adsorption at the water/air interphase. *Tenside Detergents*, 18, 310–313.
- Gargouri, Y., R. Julien, et al. (1984a). Studies on the inhibition of pancreatic and microbial lipases by soybean proteins. *J. Lipid Res.*, 25, 1214–1221.
- Gargouri, Y., R. Julien, et al. (1984b). Inhibition of pancreatic and microbial lipases by proteins. *Biochim. Biophys. Acta*, 795, 326–331.
- Gargouri, Y., H. Moreau, et al. (1989). Role of sulphhydryl group in gastric lipase. A binding study using the monomolecular film technique. *Eur. J. Biochem.*, 180, 367–371.
- Gargouri, Y., G. Pieroni, et al. (1987). Human gastric lipase - A kinetic study with dicaprin monolayers. *Eur. J. Biochem.*, 169, 125–129.
- Gargouri, Y., G. Pieroni, et al. (1986). Inhibition of lipases by proteins - a binding study using dicaprin monolayers. *Biochemistry*, 25, 1733–1738.
- Gargouri, Y., G. Pieroni, et al. (1985). Enzyme reactions in model membranes. 8. Inhibition of lipases by proteins - a kinetic study with dicaprin monolayers. *J. Biol. Chem.*, 260, 2268–2273.
- Gekko, K. and Y. Hasegawa (1986). Compressibility-structure relationship of globular proteins. *Biochemistry*, 25, 6563–6571.
- Gericke, A., J. Simon-Kutscher, et al. (1993). Influence of the spreading solvent on the properties of monolayers at the air/water interface. *Langmuir*, 9, 2119–2127.
- Green, F. A. (1971). Interactions of a nonionic detergent. II. With soluble proteins. *J. Colloid Interface Sci.*, 35, 481–485.
- Green, R. J., T. J. Su, et al. (2000). Interaction of lysozyme and sodium dodecyl sulfate at the air-liquid interface. *Langmuir*, 16, 5797–5805.
- Green, R. J., T. J. Su, et al. (2001). The interaction between SDS and lysozyme at the hydrophilic solid-water interface. *J. Phys. Chem. B*, 105, 1594–1602.
- Guillot, S., C. Moitzi, et al. (2006). Direct and indirect thermal transitions from hexosomes to emulsified micro-emulsions in oil-loaded monoglyceride-based particles. *Colloids and Surfaces a-Physicochemical and Engineering Aspects*, 291, 78–84.
- Gumpen, S., P.-O. Hegg, et al. (1979). Thermal stability of fatty acid-serum albumin complexes studied by differential scanning calorimetry. *Biochim. Biophys. Acta*, 574, 189–196.
- Gunning, P. A., A. R. Mackie, et al. (2004). Effect of surfactant type on surfactant-protein interactions at the air-water interface. *Biomacromolecules*, 5, 984–991.
- Guo, X. H. and S. H. Chen (1990). The structure and thermodynamics of protein-SDS complexes in solution and the mechanism of their transports in gel electrophoresis process. *Chem. Phys.*, 149, 129–139.
- Guo, X. H., N. M. Zhao, et al. (1990). Small-angle neutron scattering study of the structure of protein/detergent complexes. *Biopolymers*, 29, 335–346.
- Gustafsson, J., H. Ljusberg-Wahren, et al. (1996). Cubic Lipid-Water Phase Dispersed into Submicron Particles. *Langmuir*, 12, 4611–4613.
- Gustafsson, J., H. Ljusberg-Wahren, et al. (1997). Submicron particles of reversed lipid phases in water stabilised by a nonionic amphiphilic polymer. *Langmuir*, 13, 6964–6971.

- Gutman, H., G. Arvidson, et al. (1984). $^3\text{1P}$ and ^2H NMR studies of phase equilibria in the three component system: monoolein-dioleoylphosphatidylcholine. *Surfactants in Solution*. K. L. Mittal and B. Lindman (Eds.) New York, Plenum, 1, pp. 143–152.
- Hambling, S. G., A. S. McAlpine, et al. (1992). b-Lactoglobulin. *Advanced dairy chemistry: Vol. 1: Proteins*. P. Fox (Eds.) London, Elsevier Applied Science Publishers Ltd., pp. 141–190.
- Hanssens, I. and F. H. Van Cauwelaert (1978). Shielding of phospholipid monolayers from phospholipase c hydrolysis by α -lactalbumin adsorption. *Biochem. Biophys. Res. Commun.*, 84, 1088–1096.
- Haynes, C. A. and W. Norde (1994). Globular proteins at solid/liquid interfaces. *Colloids Surf. B: Biointerfaces*, 2, 517–566.
- Heckl, W. M., B. N. Zaba, et al. (1987). Interactions of cytochrome b5 and c with phospholipid monolayers. *Biochim. Biophys. Acta*, 903, 166–176.
- Heertje, I., J. Nederlof, et al. (1990). The observation of the displacement of emulsifiers by confocal scanning laser microscopy. *Food Struct.*, 9, 305–316.
- Hegg, P.-O. (1980). Thermal stability of b-lactoglobulin as a function of pH and the relative concentration of sodium dodecylsulphate. *Acta Agric. Scand.*, 30, 401–404.
- Heimburg, T., P. Hildebrandt, et al. (1991). Cytochrome c-lipid interactions studied by resonance Raman and $^3\text{1P}$ NMR spectroscopy. Correlation between the conformational changes of the protein and the lipid bilayer. *Biochemistry*, 30, 9084–9089.
- Helfrich, W. (1989). Hats and Saddles in lipid membranes. *Liq. Cryst.*, 5, 1647–1658.
- Hill, A. V. (1910). A New mathematical treatment of changes in ionic concentration in muscle and nerve under action of electron currents with a theory as to their mode of excitation. *J. Physiol.*, 40, 90–224.
- Horbett, T. A. (1984). Mass action effects on competitive adsorption of fibrinogen from hemoglobin solutions and from plasma. *Thromb. Haemost.* 174–181.
- Hønger, T., K. Jørgensen, et al. (1996). Systematic relationship between phospholipase A2 activity and dynamic lipid bilayer microheterogeneity. *Biochemistry*, 35, 9003–9006.
- Husband, F. A., P. J. Wilde, et al. (1995). A comparison of the foaming and interfacial properties of two related lipid binding proteins from wheat in the presence of a competing surfactant. *Food Macromolecules and Colloids*. E. Dickinson and D. Lorient (Eds.) London, Royal Society of Chemistry, 156, pp. 283–296.
- Hyde, S. T., S. Andersson, et al. (1984). A cubic structure consisting of a lipid bilayer forming an infinite periodic minimal surface of the gyroid type in the glycerolmonooleat-water system. *Z. Kristallogr.*, 168, 213–219.
- Hyde, S. T., A. S., et al. (1997). *The Language of Shape. The Role of Curvature in Condensed Matter: Physics, Chemistry and Biology*. Amsterdam, Elsevier.
- Ibdah, J. A. and M. C. Phillips (1988). Effects of lipid composition and packing on the adsorption of apolipoprotein A-I to lipid monolayers. *Biochemistry*, 27, 7155–7162.
- Israelachvili, J. N. and G. E. Adams (1978). Measurements of forces between two mica surfaces in aqueous electrolyte solutions in the range 0–100 nm. *J. Chem. Soc. Faraday Trans. 1*, 74, 975–1001.
- Israelachvili, J. N., D. J. Mitchell, et al. (1976). Theory of self-assembly of hydrocarbon amphiphiles into micelles and bilayers. *J. Chem. Soc. Faraday Trans. II*, 72, 1525–1568.
- Jirgensons, B. (1976). Conformational transitions of non-helical proteins effected by dodecylsulphate—circular dichroism of α 1-acid glycoprotein, Bence-Jones protein, carbonic anhydrase-B, deoxyribonuclease, pepsinogen, and plasminogen. *Biochim. Biophys. Acta*, 434, 58–68.
- Johnsson, M., J. Barauskas, et al. (2006). Physicochemical and drug delivery aspects of lipid-based liquid crystalline nanoparticles: A case study of intravenously administered propofol. *J. Nanosci. Nanotechnol.*, 6, 3017–3024.
- Jones, M. N. and A. Brass (1991). Interaction between small amphiphatic molecules and proteins. *Food, Polymers, Gels, and Colloids*. E. Dickinson (Ed.) Cambridge, Royal Society of Chemistry, 82, pp. 65–80.
- Jones, M. N. and P. Manley (1979). Binding of n-alkyl sulphates to lysozyme in Aqueous solution. *J. Chem. Soc. Faraday Trans. 1*, 75, 1736–1744.

- Jones, M. N. and P. Manley (1980). Interaction between lysozyme and n-alkyl sulphates in aqueous solution. *J. Chem. Soc. Faraday Trans. 1*, 76, 654–664.
- Jones, M. N., P. Manley, et al. (1984). Cooperativity and effects of ionic strength on the binding of sodium n-dodecyl sulphate to lysozyme. *Int. J. Biol. Macromol.*, 6, 65–68.
- Jones, M. N., P. Manley, et al. (1982). Dissociation of bovine and bacterial catalases by sodium n-dodecyl sulfate. *Biopolymers*, 21, 1435–1450.
- Kaneshina, S., M. Tanaka, et al. (1973). Interaction of bovine serum albumin with detergent cations. *Bull. Chem. Soc. Jpn.*, 46, 2735–2738.
- Kauzmann, W. (1959). Some factors in the interpretation of protein denaturation. *Adv. Protein Chem.*, 14, 1–63.
- Kim, J. and H. Kim (1986). Fusion of phospholipid vesicles induced by α -lactalbumin at acid pH. *Biochemistry*, 25, 7867–7874.
- Kinnunen, P. K. J. (1996). On the molecular-level mechanisms of peripheral protein-membrane interactions induced by lipids forming inverted non-lamellar phases. *Chem. Phys. Lipids*, 81, 151–166.
- Kinnunen, P. K. J. and J. M. Halopainen (2000). Mechanisms of initiation of membrane fusion: role of lipids. *Biosci. Rep.*, 20, 465–482.
- Komura, S. (1996). Shape fluctuations of vesicles. *Vesicles*. M. Rosoff. New York, Marcel Dekker, pp. 198–236.
- Krägel, J., R. Wüstneck, et al. (1995). Dynamic surface tension and surface shear rheology studies of mixed b-lactoglobulin/Tween 20 systems. *Colloids Surfaces A: Physicochem. Eng. Aspects*, 98, 127–135.
- Kristensen, A., T. Nylander, et al. (1997). Interaction between b-lactoglobulin and phospholipids in solution. *Int. Dairy J.*, 7, 82–92.
- Kristensen, D., T. Nylander, et al. (1996). Bovine milk sphingomyelin at the air/water interface and its interaction with wanthine oxidase. *Langmuir*, 12, 5856–5862.
- Kurihara, K. and Y. Katsuragi (1993). Specific inhibitor for bitter taste. *Nature*, 365, 213–214.
- Kuwajima, K. (1989). The molten globule state as a clue for understanding the folding and cooperativity of globular-protein structure. *Proteins: Struct. Funct. Genet.*, 6, 87–103.
- Landau, E. M. and P. L. Luisi (1993). Lipidic cubic phases as transparent, rigid matrices for the direct spectroscopic study of immobilized membrane proteins. *J. Am. Chem. Soc.*, 115, 2102–2106.
- Landau, E. M. and J. P. Rosenbusch (1996). Lipidic cubic phases: A novel concept for the crystallization of membrane proteins. *Proc. Natl. Acad. Sci.*, 93, 14532–14535.
- Landh, T. (1994). Phase behavior in the system pine needle oil monoglycerides-poloxamer 407 - water 20 °C. *J. Phys. Chem.*, 98, 8453–8467.
- Landh, T. (1995). From entangled membranes to eclectic morphologies: cubic membranes as sub-cellular space organisers. *FEBS Lett.*, 369, 13–17.
- Lapanje, S. (1978). *Physicochemical aspects of protein denaturation*. New York, Wiley.
- Larsson, K. (1983). Two cubic phases in monoolein-water system. *Nature*, 304, 664.
- Larsson, K. (1989). Cubic lipid-water phases: Structure and biomembrane aspects. *J. Phys. Chem.*, 93, 7304–7314.
- Larsson, K. (1994). *Lipids — Molecular Organization, Physical Functions and Technical Applications*. Dundee, The Oily Press Ltd.
- Larsson, K. (2000). Aqueous dispersions of cubic lipid-water phases. *Curr. Opin. Colloid Interface Sci.*, 5, 64–69.
- Larsson, K. and G. Lindblom (1982). Molecular amphiphile bilayers forming a cubic phase in amphiphile-water systems. *J. Disp. Sci. Technol.*, 3, 61–66.
- Larsson, M., K. Larsson, et al. (2002). The alveolar surface is lined by a coherent liquid-crystalline phase. *Prog. Colloid Polym. Sci.*, 120, 28–34.
- Lasic, D. D. (1993). *Liposomes - from physics to applications*. Amsterdam, Elsevier.
- Lasic, D. D., R. Joannic, et al. (2001). Spontaneous vesiculation. *Adv. Colloid Interface Sci.*, 89–90, 337–349.
- Leaver, J. and D. G. Dagleish (1992). Variations in the binding of b-casein to oil-water interfaces detected by trypsin-catalysed hydrolysis. *J. Colloid Interface Sci.*, 149, 49–55.

- LeNeveu, D. M., R. P. Rand, et al. (1977). Measurement and modification of forces between lecithin bilayers. *Biophys. J.*, 18, 209–230.
- Leslie, S. B., S. Puvvada, et al. (1996). Encapsulation of hemoglobin in a bicontinuous cubic phase lipid. *Biochim. Biophys. Acta*, 1285, 246–254.
- Lindahl, L. and H. J. Vogel (1984). Metal-ion-dependent hydrophobic interaction chromatography of α -lactalbumins. *Anal. Biochem.*, 140, 394.
- Lindblom, G., K. Larsson, et al. (1979). The cubic phase of monoglyceride-water systems. Arguments for a structure based upon lamellar bilayer units. *J. Am. Chem. Soc.*, 101, 5465–5470.
- Lindblom, G. and L. Rilfors (1989). Cubic phases and isotropic structures formed by membrane lipids - possible biological relevance. *Biochim. Biophys. Acta*, 988, 221–256.
- Lindman, B. and H. Wennerström (1980). Micelles. Amphiphile aggregation in aqueous solution. *Top. Curr. Chem.*, 87, 1–83.
- Lindström, M., H. Ljusberg-Wahren, et al. (1981). Aqueous lipid phases of relevance to intestinal fat digestion and absorption. *Lipids*, 16, 749–754.
- Lu, J. R., T. J. Su, et al. (1998). Binding of surfactants onto preadsorbed layers of bovine serum albumin at the silica-Water Interface. *J. Phys. Chem. B*, 102, 10307–10315.
- Lucassen-Reynders, E. H., J. Lucassen, et al. (1981). Surface and bulk properties of mixed anionic/cationic surfactant systems. I. Equilibrium surface tensions. *J. Colloid Interface Sci.*, 81, 150–157.
- Lunkenheimer, K. and G. Czichocki (1993). On the stability of aqueous sodium dodecyl sulfate solutions. *J. Colloid Interface Sci.*, 160, 509–510.
- Lunkenheimer, K. and R. Miller (1987). A criterion for judging purity of adsorbed surfactant layers. *J. Colloid Interface Sci.*, 120, 176–183.
- Luzzati, V. (1968). X-ray diffraction studies of lipid-water systems. *Biological Membranes*. D. Chapman (Ed.) New York, Academic Press, pp. 77–123.
- Luzzati, V. (1997). Biological significance of lipid polymorphism: the cubic phases. *Curr. Opin. Struct. Biol.*, 7, 661–668.
- Luzzati, V., A. Tardieu, et al. (1968). Structure of the cubic phases of lipid-water systems. *Nature*, 220, 485–488.
- Luzzati, V., R. Vargas, et al. (1992). Lipid polymorphism: A correction. The structure of the cubic phase of extinction symbol Fd $\bar{3}$ consists of two types of disjointed reverse micelles embedded in a three-dimensional matrix. *Biochemistry*, 31, 279–285.
- Mackie, A. R., A. P. Gunning, et al. (2001a). Orogenic displacement in mixed b-lactoglobulin/b-casein films at the air/water interface. *Langmuir*, 17, 6593–6598.
- Mackie, A. R., A. P. Gunning, et al. (2001b). In situ measurements of the displacement of protein films from the air/water interface by surfactant. *Biomacromolecules*, 2, 1001–1006.
- Mackie, A. R., A. P. Gunning, et al. (1999). Orogenic displacement of protein from the air/water interface by competitive adsorption. *J. Colloid Interface Sci.*, 210, 157–166.
- Mackie, A. R. and P. J. Wilde (2005). The role of interactions in defining the structure of mixed protein-surfactant interfaces. *Adv. Colloid Interface Sci.*, 117 3–13.
- MacRitchie, F. (1990). *Chemistry at Interfaces*. San Diego, Academic Press.
- Makino, S. (1979). Interactions of proteins with amphiphatic substances. *Adv. Biophys.*, 12, 131–184.
- Makino, S., J. A. Reynolds, et al. (1973). The binding of deoxycholate and Triton X-100 to proteins. *J. Biol. Chem.*, 248, 4926–4932.
- Malmsten, M. (1995). Protein adsorption at phospholipid surfaces. *J. Colloid Interface Sci.*, 172, 106–115.
- Malmsten, M., P. Claesson, et al. (1994). Forces between proteoheparan sulfate layers adsorbed at hydrophobic surfaces. *Langmuir*, 10, 1274–1280.
- Malmsten, M. and B. Lindman (1989). Ellipsometry studies of cleaning of hard surfaces—relation to the spontaneous curvature of the surfactant monolayer. *Langmuir*, 5, 1105–1111.
- Manne, S., J. P. Cleveland, et al. (1994). Direct visualization of surfactant hemimicelles by force microscopy of the electrical double-layer. *Langmuir*, 10, 4409–4413.

- Mariani, P., V. Luzzati, et al. (1988). Cubic phases of lipid-containing systems. Structure analysis and biological applications. *J. Mol. Biol.*, 204, 165–189.
- Mariani, P., E. Rivas, et al. (1990). Polymorphism of a lipid extract from *Pseudomonas fluorescens*: Structural analysis of a hexagonal phase and of a novel cubic phase of extinction symbol Fd—. *Biochemistry*, 29, 6799–6810.
- Maste, M. C. L., W. Norde, et al. (1997). Adsorption-induced conformational changes in the serine proteinase savinase: A tryptophan fluorescence and circular dichroism study. *J. Colloid Interface Sci.*, 196, 224–230.
- Mather, I. H. (2000). A review and proposed nomenclature for major proteins of the milk-fat globule membrane. *J. Dairy Sci.*, 83, 203–247.
- Matsumura, M., W. J. Becktel, et al. (1988). Hydrophobic stabilization of T4 Lysozyme determined directly by multiple substitution of Ile 3. *Nature*, 334, 406–410.
- Mattice, W. L., J. M. Riser, et al. (1976). Conformational properties of the complexes formed by proteins and sodium dodecyl sulfate. *Biochemistry*, 15, 4264–4272.
- Mattisson, C., T. Nylander, et al. (1996). Diffusivity measurements by holographic laser interferometry in a cubic lipid-water phase. *Chem. Phys. Lipids*, 84, 1–12.
- McCallum, C. D. and R. M. Eppard (1995). Insulin receptor autophosphorylation and signaling is altered by modulation of membrane physical properties. *Biochemistry*, 34, 1815–1824.
- McGuire, J., M. Wahlgren, et al. (1995a). The influence of net charge and charge location on the adsorption and dodecyltrimethylammonium bromide-mediated elutability of bacteriophage T4 lysozyme at silica surfaces. *J. Colloid Interface Sci.*, 170, 193–202.
- McGuire, J., M. C. Wahlgren, et al. (1995b). Structural stability effects on the adsorption and dodecyltrimethylammonium bromide-mediated elutability of bacteriophage T4 lysozyme at silica surfaces. *J. Colloid Interface Sci.*, 170, 182–192.
- Miller, R., V. B. Fainerman, et al. (2000a). Dynamics of protein and mixed protein/surfactant adsorption layers at the water/fluid interface. *Adv. Colloid Interface Sci.*, 86, 39–82.
- Miller, R., V. B. Fainerman, et al. (2000b). Adsorption characteristics of mixed monolayers of a globular protein and a non-ionic surfactant. *Colloids Surfaces A: Physicochem. Eng. Aspects*, 161, 151–157.
- Miller, R. and K. Lunkenheimer (1986). A criterion for judging the purity of surfactant solutions based on diffusion controlled adsorption kinetics. *Colloid Polym. Sci.*, 264, 273–276.
- Minami, H., T. Nylander, et al. (1996). Incorporation of proteins in the lipid-water gel state. *Chem. Phys. Lipids*, 79, 65–70.
- Mitchell, D. J. and B. W. Ninham (1981). Micelles, vesicles and microemulsions. *J. Chem. Soc. Faraday Trans. 2*, 77, 601–629.
- Mitchell, D. J., G. J. T. Tiddy, et al. (1983). Phase-behavior of polyoxyethylene surfactants with water-mesophase structures and partial miscibility (cloud points). *J. Chem. Soc. Faraday Trans. 1*, 79, 975–1000.
- Morén, A. K. and A. Khan (1995). The phase equilibria of an anionic surfactant - sodium dodecyl sulphate and an oppositely charged protein lysozyme in water. *Langmuir*, 11, 3636–3643.
- Morén, A. K. and A. Khan (1998). Surfactant hydrophobic effect on the phase behavior of oppositely charged protein and surfactant mixtures: lysozyme and sodium alkyl sulfates. *Langmuir*, 14, 6818–6826.
- Nelson, C. A. (1971). The binding of detergents to proteins. 1. The maximum amount of dodecyl-sulfate bound to proteins and the resistance to binding of several proteins. *J. Biol. Chem.*, 246, 3895–3901.
- Ninham, B. W. (2002). Physical chemistry: The loss of certainty. *Prog. Colloid Polym. Sci.*, 120, 1–12.
- Nishikido, N., T. Takahara, et al. (1982). Interaction between hydrophilic proteins and nonionic detergents studied by surface tension measurements. *Bull. Chem. Soc. Jpn.*, 55, 3085–3088.
- Norde, W. (1986). Adsorption of proteins from solution at the solid-liquid interface. *Adv. Colloid Interface Sci.*, 25, 267–340.
- Norde, W. (2000). Proteins at solid surfaces. *Physical Chemistry of Biological Interfaces*. A. Baszkin and W. Norde. New York, Marcel Dekker, Inc., pp. 115–135.

- Nozaki, Y., J. A. Reynolds, et al. (1974). The Interaction of a Cationic Detergent with Serum Albumin and Other Proteins. *J. Biol. Chem.*, 249, 4452–4459.
- Nylander, T., C. Mattisson, et al. (1996). A study of entrapped enzyme stability and substrate diffusion in a monoglyceride-based cubic liquid crystalline phase. *Colloids Surfaces A: Physicochem. Eng. Aspects*, 114, 311–320.
- Ohgushi, M. and A. Wada (1983). 'Molten-globule state': A compact form of globular proteins with mobile side-chains. *FEBS Lett.*, 164, 21–24.
- Pace, C. N., L. M. Fisher, et al. (1981). Globular protein stability: Aspects of interest in protein turnover. *Acta Biol. Med. Germ.*, 40, 1385–1392.
- Panaiotov, I. and R. Verger (2000). Enzymatic reactions at interfaces: Interfacial and temporal organization of enzymatic lipolysis. *Physical Chemistry of Biological Interfaces*. A. Baszkin and W. Norde. New York, Marcel Dekker, Inc., pp. 359–400.
- Papiz, M. J., L. Sawyer, et al. (1986). The structure of b-lactoglobulin and its similarity to plasma retinol-binding protein. *Nature*, 324, 383–385.
- Patton, J. S. and M. C. Carey (1979). Watching fat digestion. The formation of visible product phases by pancreatic lipase is described. *Science*, 204, 145–148.
- Patton, J. S., R. D. Vetter, et al. (1985). The light microscopy of fat digestion. *Food Microstruct.*, 4, 29–41.
- Piéroni, G., Y. Gargouri, et al. (1990). Interactions of lipases with lipid monolayers. Facts and questions. *Adv. Colloid Interface Sci.*, 32, 341–378.
- Ponnuswamy, P. K. (1993). Hydrophobic characteristics of folded proteins. *Prog. Biophys. Mol. Biol.*, 59, 57–103.
- Portmann, M., E. M. Landau, et al. (1991). Spectroscopic and rheological studies of enzymes in rigid lipidic matrices: The case of α -chymotrypsin in a lysolecithin/water cubic phase. *J. Phys. Chem.*, 95, 8437–8440.
- Price, M. E., R. M. Cornelius, et al. (2001). Protein adsorption to polyethylene glycol modified liposomes from fibrinogen solution and from plasma. *Biochim. Biophys. Acta*, 1512, 191–205.
- Prins, A. (1999). Stagnant surface behaviour and its effect on foam and film stability. *Colloids and Surfaces a-Physicochemical and Engineering Aspects*, 149, 467–473.
- Prins, A. and D. J. M. Bergink-Martens (1992). Dynamic surface properties in relation to dispersion stability. *Food Colloids and Polymers: Stability and Mechanical Properties*. E. Dickinson and P. Walstra (Eds.) Cambridge, The Royal Society of Chemistry, pp. 291–300.
- Privalov, P. L. (1979). Stability of proteins—small globular proteins. *Adv. Protein Chem.*, 33, 167–241.
- Privalov, P. L. (1982). Stability of proteins. Proteins which do not present a single cooperative system. *Adv. Protein Chem.*, 35, 1–104.
- Privalov, P. L. and S. J. Gill (1988). Stability of protein structure and hydrophobic interaction. *Adv. Protein Chem.*, 39, 191–234.
- Ptitsyn, O. B., R. H. Pain, et al. (1990). Evidence for a molten globule state as a general intermediate in protein folding. *FEBS Lett.*, 262, 20–24.
- Pugnaloni, L. A., E. Dickinson, et al. (2004). Competitive adsorption of proteins and low-molecular-weight surfactants: computer simulation and microscopic imaging. *Adv. Colloid Interface Sci.*, 107, 27–49.
- Puyol, P., M. D. Perez, et al. (1994). Effect of binding of retinol and palmitic acid to bovine b-lactoglobulin on its resistance to thermal denaturation. *J. Dairy Sci.*, 77, 1494–1502.
- Qui, H. and M. Caffrey (2000). The phase diagram of the monoolein/water system: metastability and equilibrium aspects. *Biomaterials*, 21, 223–234.
- Quinn, P. J. and R. M. C. Dawson (1969a). Interactions of cytochrome c and [14C]carboxymethylated cytochrome c with monolayers of phosphatidylcholine, phosphatidic acid and cardiolipin. *Biochem. J.*, 115, 65–75.
- Quinn, P. J. and R. M. C. Dawson (1969b). The interaction of cytochrome c with monolayers of phosphatidylethanolamine. *Biochem. J.*, 113, 791–803.
- Rand, R. P. (1971). Structural studies by X-ray diffraction of model lipid protein membranes of serum albumin-lecithin-cardiolipid. *Biochim. Biophys. Acta*, 241, 823–834.

- Rapoza, R. J. and T. A. Horbett (1990a). Postadsorptive transitions in fibrinogen—Influence of polymer properties. *J. Biomed. Mater. Res.*, 24, 1263–1287.
- Rapoza, R. J. and T. A. Horbett (1990b). The effects of concentration and adsorption time on the elutability of adsorbed proteins in surfactant solutions of varying structures and concentrations. *J. Colloid Interface Sci.*, 136, 480–493.
- Raudino, A. (1995). Lateral inhomogeneous membranes: Theoretical aspects. *Adv. Colloid Interface Sci.*, 57, 229–285.
- Raudino, A. and F. Castelli (1992). A thermodynamic study of protein-induced lipid lateral phase separation. Effect of lysozyme on mixed lipid vesicles. *Colloid Polym. Sci.*, 270, 1116–1123.
- Razumas, V., J. Kanapienienė, et al. (1994). Electrochemical biosensors for glucose, lactate, urea, and creatinine based on enzymes entrapped in a cubic liquid crystalline phase. *Anal. Chim. Acta*, 289, 155–162.
- Razumas, V., K. Larsson, et al. (1996a). A cubic monoolein-cytochrome c-water phase: X-ray diffraction, FT-IR, differential scanning calorimetry and electrochemical studies. *J. Phys. Chem.*, 100, 11766–11774.
- Razumas, V., Z. Talaikytė, et al. (1996b). Effects of distearoylphosphatidylglycerol and lysozyme on the structure of the monoolein-water cubic phase: X-ray diffraction and Raman scattering studies. *Chem. Phys. Lipids*, 84, 123–138.
- Rendall, H. M. (1976). Use of surfactant selective electrode in the measurement of the binding of anionic surfactants to bovine serum albumin. *J. Chem. Soc. Faraday Trans. 1*, 72, 481–484.
- Reynolds, J., S. Herbert, et al. (1968). The binding of some long-chain fatty acid anions and alcohols by bovine serum albumin. *Biochemistry*, 7, 1357–1361.
- Reynolds, J. A., J. P. Gallagher, et al. (1970). Effect of pH on the binding of n-alkyl sulfates to bovine serum albumin. *Biochemistry*, 9, 1232–1238.
- Reynolds, J. A. and C. Tanford (1970). Binding of dodecyl sulfate to proteins at high binding ratios. Possible implications for the state of proteins in biological membranes. *Proc. Natl. Acad. Sci.*, 66, 1002–1007.
- Richards, F. M. (1977). Areas, volumes, packing, and protein structure. *Annu. Rev. Biophys. Bioeng.*, 6, 151–176.
- Rytömaa, M., P. Mustonen, et al. (1992). Reversible, nonionic, and pH-dependent association of cytochrome c with cardiolipin-phosphatidylcholine liposomes. *J. Biol. Chem.*, 267, 22243–22248.
- Sagalowicz, L., M. E. Leser, et al. (2006a). Monoglyceride self-assembly structures as delivery vehicles. *Trends Food Sci. Technol.*, 17, 204–214.
- Sagalowicz, L., R. Mezzenga, et al. (2006b). Investigating reversed liquid crystalline mesophases. *Curr. Opin. Colloid Interface Sci.*, 11, 224–229.
- Sarker, D. K., P. J. Wilde, et al. (1995). Competitive adsorption of L- α -lysophosphatidylcholine/b-lactoglobulin mixtures at the interfaces of foams and foam lamellae. *Colloids Surf. B Biointerfaces*, 3, 349–356.
- Scamehorn, J. F., R. S. Schechter, et al. (1982). Adsorption of surfactants on mineral oxide surfaces from aqueous solutions. 1. Isomerically pure anionic surfactants: 1. Isomerically pure anionic surfactants. *J. Colloid Interface Sci.*, 85, 463–478.
- Scatchard, G. (1949). The attractions of proteins for small molecules and ions. *Ann. N. Y. Acad. Sci.*, 51, 660–672.
- Schönhoff, M., M. Lösche, et al. (1992). Incorporation of membrane proteins into lipid surface monolayers: Characterisation by fluorescence and electron microscopies. *Prog. Colloid Polym. Sci.*, 89, 243–248.
- Seddon, J. M. (1990). Structure of the hexagonal (H_{II}) phase, and non-lamellar phase transitions of lipids. *Biochim. Biophys. Acta*, 1031, 1–69.
- Seddon, J. M., E. A. Bartle, et al. (1990). Inverse cubic liquid crystalline phases of phospholipids and related lyotropic system. *J. Phys. Condens. Matter*, 2, SA285–SA290.
- Seifert, U., K. Berndl, et al. (1991). Shape transformations of vesicles: Phase diagram for spontaneous-curvature and bilayer-coupling models. *Phys. Rev. A*, 44, 1182–1202.
- Siminovitch, D. J. and K. R. Jeffrey (1981). Orientational order in the choline headgroup of sphingomyelin: A ^{14}N -NMR study. *Biochim. Biophys. Acta*, 645, 270–278.

- Slack, S. M. and T. A. Horbett (1988). Physicochemical and biochemical aspects of fibrogen adsorption from plasma and binary protein solutions onto polyethylene and glass, *J. Colloid Interface Sci.*, 124, 535–551.
- Spicer, P. (2005a). Cubosome processing - Industrial nanoparticle technology development. *Chem. Eng. Res. Des.*, 83, 1283–1286.
- Spicer, P. T. (2005b). Progress in liquid crystalline dispersions: Cubosomes. *Curr. Opin. Colloid Interface Sci.*, 10, 274–279.
- Spooner, P. J. R. and A. Watts (1991a). Reversible unfolding of cytochrome c upon interaction with cardiolipin bilayers. 1. Evidence from deuterium NMR measurements. *Biochemistry*, 30, 3871–3879.
- Spooner, P. J. R. and A. Watts (1991b). Reversible unfolding of cytochrome c upon interaction with cardiolipin bilayers. 2. Evidence from phosphorus-31 NMR measurements. *Biochemistry*, 30, 3880–3885.
- Steinhardt, J. and J. A. Reynolds (1969). *Multiple equilibria in Proteins*. New York, Academic Press.
- Stenstam, A., A. Khan, et al. (2001). The lysozyme-dodecyl sulfate system. An example of protein-surfactant aggregation. *Langmuir*, 17, 7513–7520.
- Subramanian, M., B. S. Sheshadri, et al. (1984). Interaction of cationic detergents, cetyl- and dodecyltrimethylammonium bromides with lysozyme. *J. Biochem. (Tokyo)*, 95, 413–421.
- Sukow, W. W., H. E. Sandberg, et al. (1980). Binding of the Triton X series of surfactants to bovine serum albumin. *Biochemistry*, 19, 912–917.
- Svensen, A. (2000). Lipase protein engineering. *Biochim. Biophys. Acta*, 1543, 223–238.
- Tamayo-Esquivel, D., A. Ganem-Quintanar, et al. (2006). Evaluation of the enhanced oral effect of omapatrilat-monolein nanoparticles prepared by the emulsification-diffusion method. *J. Nanosci. Nanotechnol.*, 6, 3134–3138.
- Tanford, C. (1967). *Physical Chemistry of Macromolecules*. New York, John Wiley & Sons.
- Tanford, C. (1980). *The Hydrophobic Effect: Formation of Micelles and Biological Membranes*. New York, John Wiley & Sons, Inc.
- Tanford, C. and Epstein (1954). The physical chemistry of insulin. I. Hydrogen ion titration curve of zinc-free insulin. *J. Am. Chem. Soc.*, 76, 2163–2169.
- Tanner, R. E., B. Herpigny, et al. (1982). Conformational change of protein sodium dodecylsulfate complexes in solution: A study of dynamic light scattering. *J. Chem. Phys.*, 76, 3866–3872.
- Templer, R. H. (1998). Thermodynamic and theoretical aspects of cubic mesophases in nature and biological amphiphiles. *Curr. Opin. Colloid Interface Sci.*, 3, 255–263.
- Tiberg, F. (1996). Physical characterization of non-ionic surfactant layers adsorbed at hydrophilic and hydrophobic solid surfaces by time-resolved ellipsometry. *J. Chem. Soc. Faraday Trans.*, 92, 531–538.
- Tilton, R. D., E. Blomberg, et al. (1993). Effect of anionic surfactant on interactions between lysozyme layers adsorbed on mica. *Langmuir*, 9, 2102–2108.
- van der Goot, F. G., J. M. González-Mañas, et al. (1991). A ‘molten-globule’ membrane-insertion intermediate of the pore-forming domain of colicin A. *Nature*, 354, 408–410.
- Vandoolaeghe, P., F. Tiberg, et al. (2006). Interfacial behavior of cubic liquid crystalline nanoparticles at hydrophilic and hydrophobic surfaces. *Langmuir*, 22, 9169–9174.
- Verger, R. (1997). ‘Interfacial activation’ of lipases: facts and artifacts. *Trends Biotechnol.*, 15, 32–38.
- Vollhardt, D. (1993). Nucleation and growth in supersaturated monolayers. *Adv. Colloid Interface Sci.*, 47, 1–23.
- Vollhardt, D. and V. B. Fainerman (2000). Penetration of dissolved amphiphiles into two-dimensional aggregating lipid monolayers. *Adv. Colloid Interface Sci.*, 86, 103–151.
- Vollhardt, D., T. Kato, et al. (1996). Nucleation and growth of three-dimensional structures in supersaturated arachidic acid monolayers: an Atomic Force Microscopy Study. *J. Phys. Chem.*, 100, 4141–4147.
- Vroman, L., A. L. Adams, et al. (1980). Interaction of high molecular weight kininogen, factor XII and fibrinogen in plasma at interfaces. *Blood*, 55, 156–159.

- Wahlgren, M. and T. Arnebrant (1996). Removal of lysozyme from methylated silicon oxide surfaces by a non-ionic surfactant, pentaethylene glycol mono n-dodecyl ether (C(12)E(5)). *Colloids Surf. B Biointerfaces*, 6, 63–69.
- Wahlgren, M., S. Welin-Klintström, et al. (1995). Competition between fibrinogen and a non-ionic surfactant in adsorption to a wettability gradient surface. *Colloids Surf. B Biointerfaces*, 4, 23–31.
- Wahlgren, M. C. and T. Arnebrant (1991). Interaction between cetyltrimethylammonium bromide and sodium dodecyl sulfate with β -lactoglobulin and lysozyme. *J. Colloid Interface Sci.*, 142, 503–511.
- Wahlgren, M. C. and T. Arnebrant (1992). The concentration dependence of adsorption from a mixture of β -lactoglobulin and sodium dodecyl sulfate onto methylated silica surfaces. *J. Colloid Interface Sci.*, 148, 201–206.
- Wahlgren, M. C., T. Arnebrant, et al. (1993a). The elutability of fibrinogen by sodium dodecyl sulphate and alkyltrimethylammonium bromides. *Colloids and Surfaces a-Physicochemical and Engineering Aspects*, 70, 151–158.
- Wahlgren, M. C., M. A. Paulsson, et al. (1993b). Adsorption of Globular Model Proteins to Silica and Methylated Silica Surfaces and their Elutability by Dodecyltrimethylammonium Bromide. *Colloid Surfaces A*, 70, 139–149.
- Wallin, R. and T. Arnebrant (1994). The activity of lipase at the cubic liquid-crystalline phase/water interface. *J. Colloid Interface Sci.*, 164, 16–20.
- Wallin, R., S. Engström, et al. (1993). Stabilisation of glucose oxidase by entrapment in a cubic liquid crystalline phase. *Biocatalysis*, 8, 73–80.
- Wallis, B. A. (1986). Structure of gramicidin A. *Biophys. J.*, 49, 295–306.
- Walstra, P. (2002). *Physical Chemistry of Foods*. New York, Marcel Dekker Inc.
- Waninge, R., T. Nylander, et al. (2003). Milk membrane lipid vesicle structures studied with Cryo-TEM. *Colloids Surf. B Biointerfaces*, 31, 257–264.
- Waninge, R., M. Paulsson, et al. (1998). Binding of sodium dodecyl sulphate and dodecyl trimethyl ammonium chloride to β -lactoglobulin: a calorimetric study. *Int. Dairy J.*, 8, 141–148.
- Waninge, R., P. Walstra, et al. (2005). Competitive adsorption between beta-casein or beta-lactoglobulin and model milk membrane lipids at oil-water interfaces. *J. Agric. Food Chem.*, 53, 716–724.
- Wannerberger, K., M. Wahlgren, et al. (1996). Adsorption from lipase surfactant solutions onto methylated silica surfaces. *Colloids Surf. B Biointerfaces*, 6, 27–36.
- Welin-Klintström, S., A. Askendal, et al. (1993). Surfactant and protein interactions on wettability gradient surfaces. *J. Colloid Interface Sci.*, 158, 188–194.
- Westesen, K. and T. Wehler (1993). Investigation of the particle-size distribution of a model intravenous emulsion. *J. Pharm. Sci.*, 82, 1237–1244.
- Wijmans, C. M. and E. Dickinson (1999). Brownian dynamics simulation of the displacement of a protein monolayer by competitive adsorption. *Langmuir*, 15, 8344–8348.
- Wilde, P. J. (2000). Interfaces: their role in foam and emulsion behaviour. *Curr. Opin. Colloid Interface Sci.*, 5, 176–181.
- Wilde, P. J. and D. C. Clark (1993). The competitive displacement of β -lactoglobulin by Tween 20 from oil-water and air-water interfaces. *J. Colloid Interface Sci.*, 155, 48–54.
- Wilde, P. J., D. C. Clark, et al. (1993). Influence of competitive adsorption of a lysopalmitoylphosphatidylcholine on the functional properties of puroindoline, a lipid-binding protein isolated from wheat flour. *J. Agric. Food Chem.*, 41, 1570–1576.
- Williams, R. J., J. N. Phillips, et al. (1955). The critical micelle concentration of sodium lauryl sulphate at 25 °C. *Trans. Faraday Soc.*, 51, 728–737.
- Worle, G., B. Siekmann, et al. (2006). Transformation of vesicular into cubic nanoparticles by autoclogging of aqueous monoolein/ploxamer dispersions. *Eur. J. Pharm. Sci.*, 27, 44–53.
- Yaghmur, A., L. de Campo, et al. (2006). Oil-loaded monolinolein-based particles with confined inverse discontinuous cubic structure (Fd3m). *Langmuir*, 22, 517–521.
- Yamamoto, Y. and M. Araki (1997). Effects of lecithin addition in oil or water phase on the stability of emulsions made with whey proteins. *Biosci. Biotechnol. Biochem.*, 61, 1791–1795.

- Yonath, A., A. Podjarny, et al. (1977a). Crystallographic studies of protein denaturation and renaturation. 2. Sodium dodecyl sulfate induced conformational changes in triclinic lysozyme. *Biochemistry*, 16, 1418–1424.
- Yonath, A., A. Sielecki, et al. (1977b). Crystallographic studies of protein denaturation and renaturation. 1. Effects of denaturants on volume and x-ray pattern of cross-linked triclinic lysozyme crystals. *Biochemistry*, 16, 1413–1417.
- Zhang, R. and P. Somasundaran (2006). Advances in adsorption of surfactants and their mixtures at solid/solution interfaces. *Adv. Colloid Interface Sci.*, 123, 213–229.
- Zhao, J., D. Vollhardt, et al. (2000). Effect of protein penetration into phospholipid monolayers: morphology and structure. *Colloids Surfaces A: Physicochem. Eng. Aspects*, 171, 175–184.
- Zhmud, B. and F. Tiberg (2005). Interfacial dynamics and structure of surfactant layers. *Adv. Colloid Interface Sci.*, 113, 21–42.
- Zoungrana, T., G. H. Findenegg, et al. (1997). Structure, stability, and activity of adsorbed enzymes. *J. Colloid Interface Sci.*, 197, 437–448.

Chapter 6

Physicochemical Aspects of an Emulsifier Functionality*

Björn Bergenståhl

6.1 Introduction

The characteristic property of all emulsifiers is their surface activity. Surface activity is the ability to form a surface excess at interfaces. The formation of adsorbed layers at interfaces are displayed in a change of a range of easily observable and technically important properties.

1. The surface tension is reduced.
2. The lifetimes of bubbles are increased. (Only very pure water displays a very short lifetime, a few seconds, of bubbles created by shaking. Normal standard “pure water,” double distilled, usually displays a bubble lifetime of about 20–30 s.)
3. The emulsifiability of oils in water is enhanced. Smaller drops with a longer lifetime are formed with less stirring.
4. The aggregation rate of dispersed particles is changed. Surface-active additives may induce or prevent flocculation of dispersions.
5. The sediment volume of settling particles is influenced. Surface additives inducing adhesive may create a loose or compact sediment.
6. Crystallization properties are changed. This may include crystallization rate and crystal shape.

This chapter aims to discuss the principal physical origin of the various functionalities of typical lipid food emulsifiers. Aspects on the functionality under very different conditions in various foods will be discussed. I will try to show how we may select emulsifiers on the basis of their fundamental properties.

6.2 Surface Activity

When an additive is added to a solution, the gain of entropy is very large at low concentrations. If the additive displays surface activity and adsorbs at an interface, the system loses entropy, which has to be balanced by a gain in free energy due to

* Reprinted unchanged from the first edition of this book

the adsorption. At very low concentrations the solubility always prevails, but when the concentration is increased, more and more of the available surfaces will be covered by the adsorbed molecules. To display surface activity, the emulsifier needs to have certain properties:

1. It has to form a noncrystalline form¹ in contact with water.
2. It should have a reduced solubility in water due to a large hydrophobic part.
3. It has to interact with water through polar interactions.
4. It should have a significant molecular weight to reduce the effect of the reduced entropy when it adsorbs.
5. It has to have a reduced solubility in an oil environment due to large size and the presence of polar groups at the interface.

High-melting emulsifiers do not display surface activity when dispersed in water until a critical temperature, the Krafft temperature, has been reached. At this temperature the emulsifier solubility in the solution has reached a sufficient concentration to allow for a significant formation of adsorbed layers at the interfaces.

The presence of hydrophobic parts of the molecules increases the energy gain due to adsorption. In aqueous environments most emulsifiers tend to aggregate in micelles at a critical concentration, cmc (critical micelle concentration), or to precipitate as liquid crystals. Above the aggregation concentration all properties depending on the chemical potential, for instance the adsorption properties, are more or less constant. The aggregation is mainly driven by the presence of the hydrophobic parts of the molecules (Tanford, 1973).

A polar part of the molecule is necessary to avoid the formation of a separate oil phase. The type of aggregates formed during the adsorption will reflect the balance between the polar part and the hydrophobic part of the molecule.

The free-energy gain at adsorption is mainly proportional to the molecular weight, while the entropy loss due to the demixing is independent of molecular weight. Hence, small molecules, for instance lower alcohols, do not form adsorbed layers at hydrophobic surfaces in contact with water solutions, while pronounced layers are formed with additives of higher molecular weights, for instance monoglycerides. Proteins display a much higher surface activity than protein hydrolysates.

In an oil environment, solvophobic effects are absent and the adsorption has to be generated by polar interactions between the second phase and the surface-active molecule.

The interaction between particles is influenced when the particles are covered by an adsorbed layer of an emulsifier. The change in the interaction strongly influences the macroscopic properties of the dispersions (Table 6.1).

¹Several lipid emulsifiers are exceptions and are applied in a hydrated gel form (α crystals). However, this crystal form resembles the liquid crystalline form in terms of interactions with both phases and spreadability over the interfaces.

Table 6.1 Effects of changes in the interactions on the macroscopic properties of dispersions

Interaction	Stability	Sedimentation
Attraction	Flocculation	Large sediment volume
Repulsion	Stable	Small sediment volume

The solution properties of emulsifiers are determined for the surface activity of the emulsifiers. In addition, the ability to generate repulsive interactions is also reflected in the solution properties of emulsifiers.

6.3 Solution Properties of Emulsifiers

When water is added to a surfactant system, the solubilization in the system may in principle pass through a series of aggregation structures and phases in a particular sequence. The sequence is: reversed micelles \rightarrow reversed hexagonal phase \rightarrow lamellar phase \rightarrow hexagonal phase \rightarrow micellar solution \rightarrow molecular solution (Fontell, 1978) (Fig. 6.1).

The free energy of solubilization, $\Delta G_{\text{solubilization}}$, can be described as a sum of free energy contributions in the process by the expression: emulsifier phase + water \rightarrow more solubilized phase:

$$\Delta G_{\text{phase transformation}} + \Delta G_{\text{mixing}} + \Delta G_{\text{polar group/water interaction}} + \Delta G_{\text{hydrophobic}}$$

where ΔG_{mixing} is negative when changing from large aggregates to small aggregates (micelles and molecular solutions).

$\Delta G_{\text{hydrophobic}}$ is positive and equal to $A_{\text{hydrocarbon/water}} \gamma_{\text{hydrocarbon/water}}$. The hydrophobic effect is the driving force for the aggregation and gives the upper limit of the molecular solubility for amphiphilic molecules (critical micelle concentration).

$\Delta G_{\text{polar group/water}}$ is negative. This term consists mainly of the work released when more water allows a larger separation between repelling aggregates or molecules:

$$\Delta G_{\text{polar group/water}} = \sum_{\text{all neighbors}} \left\{ \int_{\text{aggregate}}^{\text{next aggregate}} F(l) dl \right\}$$

where l is the average distance between the polar groups and $F(l)$ is the interaction.

The area per molecule in the aggregates is given by the balance between the interfacial tension of the oil/water interface and of the space needed for the polar group itself and the space generated by repulsive interactions between the emulsifier head groups at the interface.

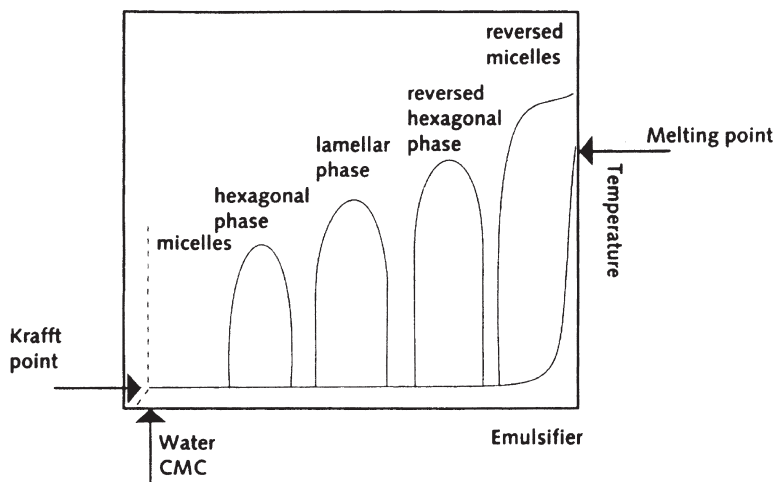

Fig. 6.1 A typical sequence of liquid-crystalline phases and solution phases formed in a binary emulsifier mixture. (Modified from Fontell, 1978.)

The area per molecule expands in the series $A_{\text{reversed micelles}} < A_{\text{reversed hexagonal}} < A_{\text{lamellar}} < A_{\text{hexagonal}} < A_{\text{micelles}}$.

At a specific ratio of water and emulsifier, the system's tendency is to obtain aggregates as small as possible to maximize the ΔG_{mixing} and the $\Delta G_{\text{polar group/water}}$. The lower limit in aggregate size is given by the increased hydrophobic contact between the exposed hydrocarbon/water interface.

The interesting result of this exercise is that the area per molecule is to a large extent a measure of the ability to generate repulsive interactions.

In the solubilization sequence, reversed aggregates \rightarrow lamellar phase \rightarrow hexagonal phase \rightarrow micellar solution \rightarrow molecular solution, the area per molecule of the surfactant/water interface increases. Depending on the packing constraints given by the hydrophobic moiety in the aggregates, the range of the repulsive interaction on the polar side of the molecule, and the molecular weight, this process has to proceed more rapidly or more slowly (Israelachvili et al., 1976, 1977). Hence, the packing constraints of the hydrocarbon chain are an important link between properties and aggregation.

The ratio of the actual area A , as it is created by the repulsive interactions, to the theoretical area of a saturated hydrocarbon chain, A_0 (23 \AA^2) enforces different geometries (Israelachvili et al., 1976, 1977) due to the different ratio of volume to area of different aggregates, as shown in Table 6.2.

The successive solvation of surfactants in Table 6.2 correspond to a successive change into aggregates that correspond to a more long-range interaction. If there is an upper limit for the repulsion, the solvation series is terminated at that stage. Hence, the maximum solvated aggregate formed at a surplus of water is a measure of the ability of the emulsifier to generate repulsive interactions.

Table 6.2 The geometries of different aggregates

Area volume	Packing constraint ^a ($A_0 = 23 \text{ \AA}^2$ for a saturated hydrocarbon tail)
Sphere (micellar solution)	
$\frac{2\pi r^2}{(4/3)\pi r^3} = \frac{2}{r}$	$\frac{3 \times V_{\text{hydrophob}}}{r_{\text{hydrophob}}} = 3A_0$
Rods (hexagonal phase)	
$\frac{2r\pi l}{\pi \times r^2 l} = \frac{2}{r}$	$\frac{2 \times V_{\text{hydrophob}}}{r_{\text{hydrophob}}} = 2A_0$
Bilayers (lamellar phase)	
$\frac{2l^2}{2rl^2} = \frac{1}{r}$	$\frac{1 \times V_{\text{hydrophob}}}{r_{\text{hydrophob}}} = A_0$
Reversed rods (reversed hexagonal phase)	
$\frac{2\pi r_{\text{aq}} l}{\pi l [(r + r_{\text{aq}})^2 - r_{\text{aq}}^2]} = \frac{2}{r(1 + \sqrt{1 + 1/\phi_{\text{aq}}})}$	$< A_0$

r = radius of the aggregate, usually limited by the length of molecule

l = a fictitious length of the aggregate

$V_{\text{hydrophob}}$ = volume of the hydrophobic part of the molecule

$r_{\text{hydrophob}}$ = the maximum length of the hydrophobic moiety

A_0 = area of a cylindrical packing of the hydrophobic moiety (= $V_{\text{hydrophob}}/r_{\text{hydrophob}}$ or 23 \AA^2 per hydrocarbon chain)

A = area per molecule at an average water/amphiphilic interface

^a The packing constraint is here defined as the necessary cross section of an amphiphilic molecule in the aggregate at the oil/water interface. This definition is A_0 /packing parameter according to Israelachvili et al. (1992, 1976, 1977).

The area of the molecule is a measure of the interaction when water is available, and may be generalized as the hydrophilicity of the molecule. The spatial requirement of the hydrophobic part of the molecule is of course a measure of the hydrophobicity of the molecule. Consequently, there is a close link with the classical view of emulsifiers as molecules with a balance between the hydrophobic and the hydrophilic properties, as they are expressed in the HLB numbers, proposed by Griffin (1949, 1979).

6.4 The Use of Phase Diagrams to Understand Emulsifier Properties

Friberg and coworkers (Wilton and Friberg, 1971; Friberg and Mandel, 1970b; Friberg and Rydhag, 1971; Friberg and Wilton, 1970; Rydhag, 1979; Rydhag and Wilton, 1981; Friberg et al., 1969; Friberg and Mandel, 1970a; Friberg, 1971) have investigated phase

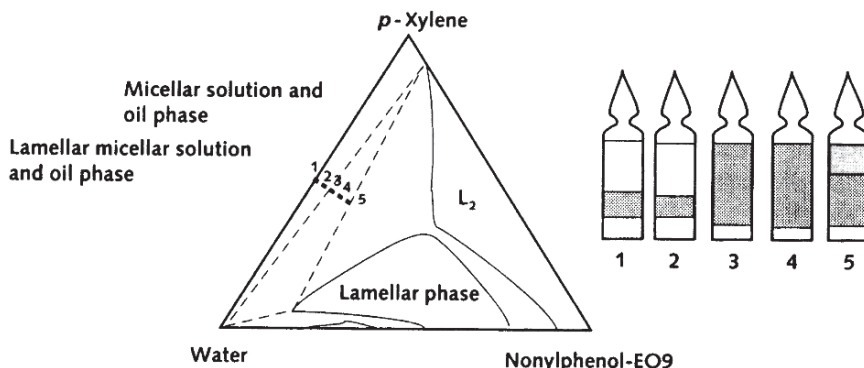

Fig. 6.2 Emulsion experiments in the phase diagram of an ethoxylated nonyl-phenol and xylene. Systems with compositions corresponding to the position in the phase diagram were weighed into flame-sealed ampoules. The emulsifiability of the systems was tested by shaking the ampoules. The stability of the emulsions formed was observed the emulsification. (*Modified from Friberg et al., 1969; Friberg and Mandell, 1970a.*)

diagrams and emulsion stability extensively. They concluded that the optimum composition for a stable emulsion should be that at which the lamellar phase, the oil phase, and the water phase are in equilibrium in the corresponding phase diagram (Fig. 6.2).

The relation between the formation of lamellar phases and emulsion stability is basically of an empirical nature. The emulsifiability is enhanced at certain compositions (Friberg and Mandel, 1970b; Friberg and Rydhag, 1971; Friberg and Wilton, 1970), and the formation of crystalline phases corresponds to an observed destabilization (Wilton and Friberg, 1971). The formation of multilayers around the emulsion droplets under certain conditions has also been shown (Friberg, 1990).

It was suggested that the formation of a multilayer of a lamellar liquid-crystalline phase coating the droplet surface reduces the van der Waal's attraction and that this was an important contribution to the observed effects in the emulsification experiments (Friberg, 1971). However, this explanation is not a useful general explanation since the emulsifier concentration in optimized food emulsions rarely is high enough to allow for multilayer adsorption (Walstra, 1988; Dickinson, 1986). Obviously, this observation is contradictory to the need for a separate phase of liquid-crystalline material around the droplet. However, a correlation between the presence of, or the possibility to form, liquid-crystalline phases and emulsion stability is still experimentally observed in several systems. To stabilize a dispersion, the emulsifier should

1. Contribute to the repulsive interactions between the droplets
2. Contribute to the interfacial viscosity
3. Be well anchored to the interface

These properties are reflected in the formation of various liquid-crystalline phases (Table 6.3). These aspects are illustrated by a few examples.

Table 6.3 The relation between the function of an emulsifier to stabilize an emulsion and its ability to form various aggregation structures

Stabilizing property aggregates	Micelles	Bilayers	Reversed
	Water-continuous emulsions		
Repulsive interactions	Optimal	Intermediate	Weak
Interfacial viscosity	Weak Optimal	Weak	
Anchoring	Too water-soluble	Optimal	Acceptable
Oil-continuous emulsions			
Repulsive interactions	Weak	Intermediate	Optimal
Interfacial viscosity	Weak	Optimal	Weak
Anchoring	Acceptable	Optimal	Too oil-soluble

6.5 Examples of the Relation between Phase Diagrams and Emulsion Stability

6.5.1 Monoglycerides

A technical monoglyceride at room temperature remains in a nonhydrated crystalline phase (β phase) in equilibrium with a surplus of water. Above 40°C, the monoglyceride takes up water and a lamellar phase is formed (Wilton and Friberg, 1971). The lamellar phase coexists with a surplus of water (no micelles are formed). When the lamellar phase is cooled, a semicrystalline phase, termed “ α phase,” is formed. This phase is metastable below 30°C and converts only slowly into an aqueous and a β phase.

The swelling of the lamellar and α phases indicates the existence of a strong repulsive hydration force. This force has been measured by the osmotic stress technique (Fig. 6.3). In contrast, no hydration force strong enough to separate the bilayers is present in the β phase. The hydration force between emulsion droplets coated with this emulsifier depends on the liquid-crystalline state of the adsorbed emulsifier film in the same way. This explains why monoglycerides appearing in the β form are inactive as emulsifiers, and why a monoglyceride-stabilized emulsion rapidly destabilizes when the monoglyceride converts from lamellar or α into β phase (Wilton and Friberg, 1971). In technical systems, it is important that the conversion of α phase into β phase is delayed. An α phase can be stabilized by the presence of ionic charges (soap) (Larsson and Krog, 1973) or by a wide distribution of the fatty acid-chain composition. The solution properties of a range of food emulsifiers are summarized in Table 6.4.

6.5.2 Lecithins

Lecithin is one of the most commonly used food emulsifiers, and its popularity can be expected to grow even further due to its natural origin. Technical lecithins, usually soybean lecithin, are always natural mixtures of various phospholipids. The most

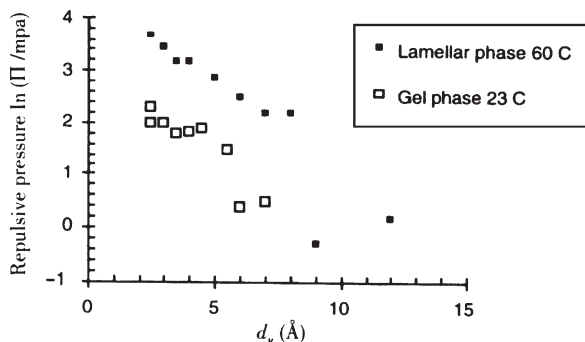

Fig. 6.3 The hydration repulsion between bilayers of monopalmitin in the liquid-crystalline and gel states. (Redrawn from Pezron *et al.*, 1991.)

Table 6.4 Formation of liquid-crystalline phases by lipid emulsifiers

Emulsifier	Fatty acid	Liquid-crystalline phases formed at	Upper swelling limit (at 25°C)	
Monoglycerides:				
Distilled saturated	C18–16	Lamellar phase at 50°C Cubic at 70°C	50%	Krog, 1990
Distilled unsaturated	C18:1–2	Cubic < 20°C Reversed hexagonal at 55°C	35%	Krog, 1990
Monoolein	C18:1	Cubic < 20°C Reversed hexagonal at 90°C	40%	Krog, 1990
Tetraglycerolesters:				
Tetraglycerol monolaurin	C12	Lamellar < 20°C Fluid isotropic 40°C	55%	Krog, 1990 ^a
Organic acid esters:				
Diacetyl tartaric acid monoglyceride ester	C16–18	Lamellar 45°C	55%	Krog, 1990
Sodium steraoyl lactylate:				
pH 5	C18	Reversed hexagonal at 45°C	40%	Krog, 1990
pH 7	C18	Lamellar at 42°C	60%	Krog, 1990
Sorbitan eslers:				
Polyoxyethylene (20) sorbitan monooleate	C18:1	Hexagonal phase (up to 30°C) and micellar solution	—	Hall, Pethica, 1967
Polyoxyethylene (20) sorbitan monostearate	C18	Hexagonal phase (30 to 50°C) and micellar solution above 30°C	—	Hall, Pethica, 1967
Sorbitan stearate	C18	Lamellar above 50°C	—	Hall, Pethica, 1967

^aThe data are extracted from a review of several original sources

frequent one is phosphatidylcholine (PC). The second is phosphatidylethanolamine (PE). Phosphatidylinositol (PI) and phosphatidic acid (PA) are usually present at intermediate levels, and phosphatidyl serine (PS), lysophosphatides (LPC and LPE), etc., at low levels. Nonphosphatides such as steroids, vitamin E, and free fatty acids are usually also present in technical products. The properties of lecithins reflect some type of average properties of the mixture. This section will first describe the characteristic properties of the most common phosphatides and then discuss the properties of various mixtures.

6.5.3 Phosphatidylcholine

The phase diagram of a typical unsaturated phosphatidylcholine is displayed in Fig. 6.4. The phase diagram is characterized by a large swelling lamellar phase. Saturated phosphatidylcholines have a phase transition temperature up to about 40°C, whereas the corresponding temperature for unsaturated lecithins is well below 0°C. The phase diagram of soybean PC is described in Bergenståhl and Fontell (1983) and is rather similar to the phase diagram of dioleoyl PC.

6.5.4 Phosphatidylethanolamine

Phosphatidylethanolamine is less hydrophilic than PC. The saturated ethanolamines form lamellar phases that swell less than the corresponding PC species. The phase transition temperature is about 10 to 40°C above the corresponding temperature of the phosphatidylcholine (Fig. 6.5). The more limited ability to create long-range repulsive interactions, and thereby to defend a large molecular area, is displayed in the tendency to form reversed hexagonal phase with unsaturated PE species, as shown in Table 6.5.

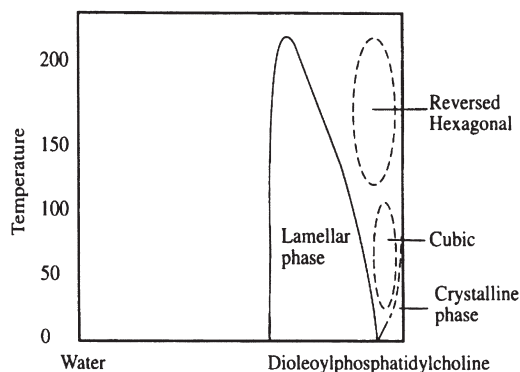

Fig. 6.4 The phase diagram of water and dioleoylphosphatidylcholine. (From Bergenståhl and Stenius, 1987.)

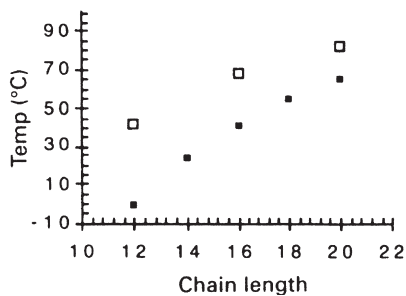

Fig. 6.5 The main transition temperature for phosphatidylcholine (PC) (□) and phosphatidylethanolamine (PE) (○) as a function of chain length. The sources of data are given in Table 6.4

Table 6.5 The formation of liquid-crystalline phases by various phospholipids

Phospholipid	Fatty acids	Liquid-crystalline phases formed at	Upper swelling limit (at 25°C)	
Phosphatidylcholine:				
Distearoyl	C18	Lamellar phase at 55°C	—	Small, 1986 ^b
Dipalmitoyl	C16	Lamellar phase at 41°C	36%	Insko & Matsui, 1978
Dimyrisoyl	C14	Lamellar phase at 23°C	40%	Janiak et al., 1978
Dioleoyl	C18:1	Lamellar below 0°C	42%	Bergenståhl & Fortell, 1987
Egg PC	C16–18:1	Lamellar at 2°C	44%	Small, 1986
Soybean PC	C18:1–2	Lamellar below 0°C	35%	Bergenståhl & Fortell, 1987
Phosphatidylethanolamine:				
Dipalmitoyl	C16	Lamellar phase at 68°C Reversed hexagonal at 84°C	20%	Caffrey, 1985
Dioleoyl	C18:1	Lamellar below 0°C Reversed hexagonal at 5°C	20%	Gawrish et al, 1992
Soybean PE	C18	1–2 ^a Reversed hexagonal above 0°C	30%	Bergenståhl, 1991
Phosphatidylinositol:				
Soybean PI	C18:1–2 ^a	Lamellar below 0°C	Unlimited	Bergenståhl, 1991 Söderberg, 1990

(continued)

Table 6.5 (continued)

Phospholipid	Fatty acids	Liquid-crystalline phases formed at	Upper swelling limit (at 25°C)	
Phosphatidic acid:				
Dioleoyl	C18:1	Lamellar below 0°C	Unlimited	Lindblom et al., 1991
Lyso PG:				
Palmitoyl	C16	Micellar solution below 0°C	Unlimited	Eriksson et al., 1987

^aMainly^bThe data are extracted from a review of several original sources

6.5.5 *Phosphatidylinositol*

The phase diagram of soybean PI and water has been determined by the author (1991) and by Söderberg (1990). The diagram is characterized by a large lamellar phase with an unlimited swelling. The liquid-crystalline phase is formed below room temperature.

6.5.6 *Phosphatidic Acid*

The phase diagram of the sodium salt of dioleoylphosphatidic acid has been determined by Lindblom et al. (1991). The phase diagram is characterized by a lamellar phase that transforms to a reversed hexagonal phase at about 30% of water. This transformation occurs although there is an ionic charge on the molecules and despite the small head group. A possible explanation, supported by evidence from NMR measurements, is that this is due to ion condensation.

6.5.7 *Lysophosphatides*

The phase diagrams of a series of different lysophosphatides has been investigated by Arvidsson et al. (1985). Lysophosphatidylcholine has the same hydrophilic polar group as the ordinary PC but only one of the two fatty acids. This reduces the volume demand of the aggregate, and the packing constraint allows for the formation of micelles and hexagonal phases.

6.5.8 *The Properties of Mixtures of Phosphatides*

Technical phosphatides are always mixtures. Their properties reflect some type of average that the mixture develops. One way to investigate this is to determine the type of liquid-crystalline phase that develops when different phosphatides are

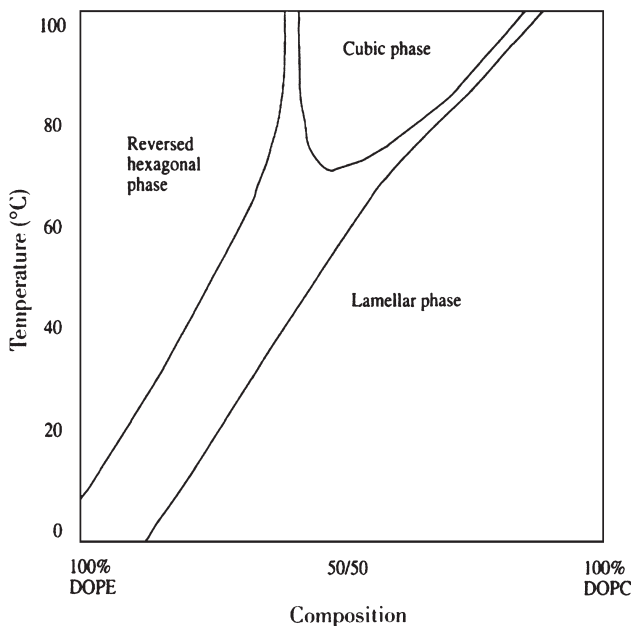

Fig. 6.6 The phase diagram of dioleoyl PC and dioleoyl PE with 40% water. (Redrawn from Eriksson et al., 1985.)

allowed to interact together with water. Fig. 6.6 shows the phase diagram of dioleoyl PC and dioleoyl PE in 40% water (Eriksson et al., 1985). The figure shows that a lamellar phase is formed when the system contains mainly PC, but that about 60% PE nonlamellar phases start to form. This change is enhanced at high temperatures. Between the hexagonal phase and the lamellar phase is an area in which a cubic phase appears (above 50°C).

The more highly unsaturated soybean PE and soybean PC display a similar aggregation pattern, but the temperature at which the system changes from lamellar to nonlamellar phases is lower (Fig. 6.7), and the phase diagram is dominated by the hydrophobic properties of the PE up to fairly high concentrations of PC. A mixture of PI and PC displays the extreme swelling properties of ionically charged emulsifiers at an early stage. This was indeed also expected since a similar pattern was observed when a small amount of ionically charged detergents was added to the lamellar phase formed by monoglycerides (Larsson and Krog, 1973). When PI and PE are mixed, the properties of the mixture are dominated by the hydrophilic PI up to quite a high PE:PI ratio.

A preliminary conclusion from this work is that the properties of phosphatide mixtures are determined by the ratio of anionic (particularly PI) phosphatides to PE rather than by the PC:PE ratio.

Technical soybean lecithin contains a mixture of different phospholipids (Rydahg, 1979). In most cases, the weakly hydrophilic phosphatidylethanolamine

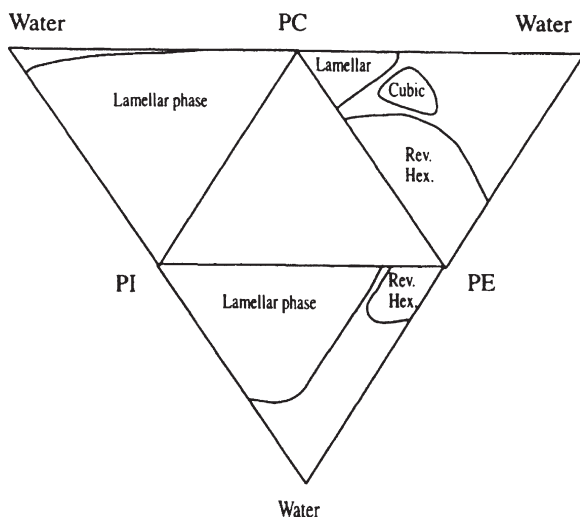

Fig. 6.7 The phase diagram of soybean PC, soybean PE, and water; of soybean PC, soybean PI, and water; and of soybean PI, soybean PE, and water. (*Redrawn from Bergenståhl, 1991.*) The cubic phase was not included in the original drawing, but it is a possible interpretation of the x-ray peaks included in the paper. It is also supported by the data from the study by Eriksson et al. (1985).

dominates, and this type of lecithin is suitable for inverse emulsions such as in margarine. More hydrophilic soybean lecithins suitable for oil-in-water emulsions are obtained by partial hydrolysis to form lysolecithins (Emulfluid E).² It is also possible to increase the effective hydrophilicity of the PE by making the polar head group larger through acetylation (Emulfluid A).

6.6 Some Ways to Classify Emulsifiers

A common problem in industrial development work is the choice of suitable surfactants to obtain the desired results. In the literature a number of different methods of making a fast preliminary selection of suitable emulsifiers have been proposed. The most common methods and concepts are discussed here and are compared with the function of the emulsifier in the emulsion.

6.6.1 The Solubility Concept

One of the first ideas, proposed by Bancroft (1913) at the beginning of the century, was that the solubility of the emulsifier determines the type of emulsion that is formed. An oil-soluble emulsifier will create an oil-continuous emulsion, and a

² Emulfluid™, Lucas Meyer, Elbdeich 62, Hamburg, Germany

Table 6.6 Emulsifiability compared with solubility according to the Bancroft rule (*Östberg et al.*, 1995)

Emulsifier	Solubility/dispersibility	Type of emulsion
Sorbitan esters (Span)	Oil-soluble	Oil-continuous
Ethoxylated sorbitan esters (Tween)	Water-soluble	Water-continuous
Hydrophobic lecithin (normal technical lecithin)	Oil-dispersible	Oil-continuous
Hydrophilic lecithin (high LPC or low PE)	Water-dispersible	Water-continuous
Proteins	Water-soluble	Water-continuous
Fat crystals	Oil-dispersible	Oil-continuous

water-soluble emulsifier will turn the emulsion into a water-continuous one. This is true for low molecular emulsifiers with a high solubility (usually in micellar aggregates), but it is also valid for polymers. However, most likely, the concept can also, to some extent, be expanded to include emulsifiers with just a dispersibility in either one of the phases (for instance lecithin). Experience in this direction is exemplified in Table 6.6. However, the Bancroft rule provide us just with the first very general directions. To proceed further we need possibilities to rank emulsifiers quantitatively.

6.6.2 *The Phase Inversion Concept*

Ethoxylated surfactants have a tendency toward declining hydrophilicity with increasing temperature. This leads to a change from water solubility at low temperatures to oil solubility at higher temperatures. According to the Bancroft rule, this will cause a given system to switch from being water-continuous to being oil-continuous. The hydrophilicity can be viewed as a property that is gradually lost with increasing temperature. The distance from the breakeven point, the phase-inversion temperature (PIT), is then a measure of the strength of the hydrophilicity. Shinoda claims that the best stability of an oil-in-water emulsion is obtained at 30°C below the PIT and for a water-in-oil emulsion at about 20°C above the PIT. However, the droplet v obtained directly after the homogenization (by shaking) reach a minimum at the PIT. Consequently, Shinoda suggests that the emulsifier should be chosen so that the emulsification can be performed at a PIT about 20–30°C above the final storage temperature [emulsification by the PIT method (Shinoda and Saito, 1968)].

Shinoda and coworkers (Shinoda and Saito, 1968; Shinoda and Kunieda, 1983; Kunieda and Ishikawa, 1985, reviewed in Shinoda and Friberg, 1986) have worked according to this concept and characterized a number of different ethoxylated emulsifiers in combination with various solvents. They then found that the PIT depends not only on the number of ethoxy groups but also on the oil phase, indicating the importance of the solubility properties for the stability.

Emulsification experiments performed with a range of different oil-to-water ratios show that the emulsion type is determined mainly by the emulsifier properties and is for many systems (pure solvents!) very insensitive to the phase ratio (Shinoda and Friberg, 1986).

It is obvious that this says a lot about the properties of ethoxylated surfactants but its applicability to food emulsions is very limited for two main reasons:

1. The concept is based on strongly temperature-dependent properties of the emulsifiers. This excludes ionic emulsifiers (less important for the food industry), and it also excludes the most commonly used polyhydroxy and nonionic zwitterionic emulsifiers as they display a very weak temperature dependence of their hydrophilicity.
2. The solvent properties are important in the PIT concept. However, food emulsions are made almost solely from triglyceride oils and water that will behave differently due to the large molecular weight of the oil molecules.

6.6.3 The HLB (Hydrophilic/Lipophilic Balance) Concept

Emulsifiers are molecules with a duality in their properties. The balance between the hydrophobic and hydrophilic properties of the molecules should then determine the performance, for instance to the type of emulsion formed. If the emulsifier is changed from being hydrophobic to hydrophilic, the emulsion formed changes from oil-continuous to water-continuous. The balance of the emulsifier is recorded as a number, the HLB value. When this concept was introduced by Griffin (1949), the HLB value of unknown emulsifiers was determined by comparing the emulsification properties in a predetermined system of a mixture of hydrophobic and hydrophilic emulsifiers with a predefined HLB number.

The important development of the HLB system came when the group contribution system was constructed by Davies (1957), and it became possible to estimate an HLB value of an unknown emulsifier from the molecular formula (Table 6.7).

Table 6.7 Calculation of HLB numbers according to Davies (1957). The table is modified according to Davies (1957). $HLB = 7 + \Sigma$ group contributions (From Bergenst ahl and Claesson, 1990)

Group	Group contribution
Carboxylic acid soap	21.2
Sorbitan ester	6.8
Glyceryl ester	5.25
Ester	2.4
Carboxylic acid	2.1
Alcohol	1.9
Ether	1.3
EO group	0.33
CH ₃ , CH ₂ , CH	-0.475

The advantage of the HLB concept is that it makes it possible to characterize numerous emulsifiers and emulsifier blends (it is usually assumed that it is possible to calculate an average HLB value from the w/w composition). Large tables of data for commercial emulsifiers are also available.

The limitation of the HLB value is that it provides a rather one-dimensional description of the properties (molecular weight and temperature dependence are omitted). It is also difficult to calculate useful HLB values for several important food emulsifiers, for instance phospholipids. The HLB values do not include the important crystallization properties of monoglycerides and modified monoglycerides.

6.6.4 A Comparison Between the HLB and the Geometry of the Molecule

There is an obvious analogy between the idea of a hydrophilic lipophilic balance and that of a balance in the molecules that are appearing in the packing constraints creating the different association structures (Fig. 6.8). Griffin (1978) has also suggested a relationship between various solution properties and the HLB number. Transforming these descriptions into various aggregation structures, a clear relation between the molecular packing and the HLB value is obtained.

This result shows that the ability to form liquid-crystalline phases corresponds to the traditional HLB characterization of the emulsifiers.







Aggregate	Shape	Character in solution	HLB	A/A_0
 Micelles		Clear solution	> 13	> 2
 Lamellar phase		White dispersion Milky appearance	7–10	1–2
 Reversed aggregates		Lumps of emulsifier	< 7	< 1

Fig. 6.8 A comparison between molecular aggregation, solution characteristics, A/A_0 , and the packing parameter. (Modified from Bergenståhl and Claesson, 1990.)

6.6.5 *The Role of the Emulsifier in Homogenization*

The discussion so far has been dealing mainly with the situation when droplets are protected by a layer of emulsifier. However, the emulsifiers also have a crucial role during the emulsification that usually is included in all empirical tests that are the bases for the rules.

When an emulsion is created from a large and homogeneous oil phase, the emulsifier should support two different processes: the formation of new droplets and protection against re-coalesce. The emulsifier acts according to both static and dynamic (diffusion-induced) interactions (Walstra, 1983) (Table 6.8).

The principal role of the interfacial tension is obvious. The presence of emulsifiers lowers the interfacial tension from about 30 mN/m for a triglyceride/water system to between 1 and 10 mN/m. Nonionic emulsifiers close to the PIT create densely packed interfaces with very low interfacial tensions. However, the effects of the interfacial tension itself are not very large. Walstra (1983) has shown that the droplet size is only weakly dependent on the interfacial tension.

During the homogenization, new interfaces are formed. The emulsifiers have to diffuse to the interfaces to lower the interfacial tension during the events when the droplets are formed. This process must be rapid to be successful, as rapid as the time scale for the formation of the droplets. For geometrical reasons, the diffusion from the surrounding phase of the droplet is much more rapid than the diffusion from the internal liquid. This is one important contribution to the validity of the solution rules (Bancroft, PIT, HLB, and phase diagrams).

During the homogenization, the water-soluble substances in the oil phase diffuse over to the water phase. These types of diffusion across the interfaces create disturbances that contribute to the emulsification. In many systems, this effect gives an increased efficiency if the emulsifier is added to the oil phase before the emulsification. For dispersible emulsifiers (phospholipids) there are also other reasons why it is more efficient to add the emulsifier to the oil phase instead of the water phase. During the homogenization, phospholipids tend to form stable liposomal dispersion in competition to the emulsification of the oil phase. Westesen has indeed observed that a significant fraction of the phospholipids in a commercial phospholipid emulsion for paraneal use is lost in liposomal aggregates (Westesen and Wehler, 1992).

Emulsification involves an intensive shear. The shear by itself causes a high frequency of re-coalescence events. If the emulsification is to be successful the formed droplets have to be protected. The repulsive interactions generated by the emulsifiers create a static protection.

Table 6.8 The role of the emulsifiers during the formation of emulsions

	Static	Dynamic
Destabilize the interfaces	Interfacial tension	Diffusion to and across the interfaces
Stabilize the droplets	Repulsive surface forces	Diffusion to the interfaces

The hydrodynamic interaction is crucial for the result of a collision due to shear. The hydrodynamic interactions depend on the existence of an interface with an interfacial viscosity and elasticity. During the collision event, the interface close to the approaching droplet is depleted of emulsifiers due to the streaming of liquid. The surfactant-depleted zone will then have a higher interfacial tension than the surrounding emulsifier-covered areas of the droplets. This leads to surface diffusion in the direction opposite to the liquid flow and ensures the hydrodynamic resistance. If the emulsifier is oil-soluble, emulsifier from the internal part of the droplet will diffuse to the depleted area and thereby reduce the hydrodynamic protection of the droplet.

The discussion in this section has been very qualitative, but an important point is that the emulsifiers contribute to the emulsification as well as to the stabilization. The role of the emulsifier for the stabilization is usually difficult to identify in the simple type of shaking experiments that are the main background to the HLB, the PIT, and the phase diagram concepts. This type of simple, and thereby efficient, experiment provides information about both the emulsifiability and the stability with a certain emulsifier.

6.7 The Emulsifier Surface

The ability of various food emulsifiers to generate adsorbed layers influencing the interparticle interactions has been discussed. The type and magnitude depend on the composition of the surface generated from the adsorption process. Foods usually are complex mixtures. They may contain both low molecular surface-active lipids and a versatile range of more or less surface-active proteins and polysaccharides. The actual chemical composition of the emulsion droplet surface is then the key factor that determines most of the surface interactions.

In systems containing several surface-active components, three types of adsorbed layers can be identified based on how the layers are formed. In reality, the differences between the three adsorption structures discussed below are not sharp, but this simplified description can provide a base when the properties of complex systems are discussed.

1. *Competitive adsorption*. A monolayer containing one predominant type of molecule at the interface builds up through competition with other less surface-active components that may be replaced in the interface.
2. *Associative adsorption*. An adsorbed layer containing a mixture of several different surface-active components is formed.
3. *Layer adsorption*. One component adsorbs on top of the other.

6.7.1 *Competitive Adsorption*

In a system with several surface-active components, a homogeneous monolayer is formed by the most surface-active component. The adsorption depends on the main driving force for adsorption, mainly the hydrophobic interaction. Hence,

from a mixture of two emulsifiers, the most hydrophobic emulsifier will have the strongest affinity to the interface. A consequence is that under competitive adsorption the component with the lowest water solubility will dominate the interface [e.g., the lowest critical micelle concentration (Kronberg, 1983)].

The character of the adsorbed layer, for instance its ability to generate repulsive interactions, is determined by the dominating compound. The structure of the layer depends on the geometrical shape of the molecules and on lateral interactions between the molecules in the layer. Nonionic surfactants may form very dense layers due to head-group attraction. Ionic surfactants are able to form extremely loose layers due to inter-head-group repulsion.

An interesting experimental observation in agreement with this relation is that the concentration of emulsifier necessary to obtain an emulsion is much lower for ionic emulsifiers than for nonionic emulsifiers.

In a series of emulsions, we have studied the efficiency of the emulsification (Östberg et al., 1995) by droplet size measurements after homogenization. The results show that for several emulsifiers very small droplets are obtained (about 0.2–0.4 μm). The particle size obtained depends on the concentration of emulsifier. The nonionic emulsifiers leads to a constant particle size down to a critical concentration below which the ability to form emulsions is strongly reduced. The critical concentration can be compared with the thickness of the emulsifier layer on the emulsion droplet. The apparent thickness of the emulsifier layer can be estimated from the particle size and the concentration of emulsifier (counted on the dispersed phase). if we assume that all emulsifier is adsorbed to the interface. The apparent thickness gives the upper limit for the absorbed layer rather than the correct value:

$$\text{Thickness of emulsifier layer} = \frac{\text{volume of emulsifier}}{\text{emulsion droplet area}}$$

$$\delta = \frac{c_{\text{em}} V_{\text{emulsion droplet}}}{A_{\text{emulsion droplet}}} = \frac{c_{\text{em}} \pi d^3 / 6}{\pi d^2} = \frac{c_{\text{em}} d}{6}$$

where c_{em} is the emulsifier concentration (v/v) in the disperse phase.

The critical thickness (the thickness of the emulsifier layer at the critical concentration) of the emulsifier layer can be compared with the size of the molecule. The results show a thickness of about 60% of the theoretical length of the molecule for nonionic emulsifiers. Hydrophobic emulsifiers are less efficient during the emulsification and give very high values of the apparent thickness. The properties of the ionic emulsifiers are different. These emulsifiers are able to emulsify the emulsions down to extremely low concentrations corresponding to very low surface concentrations (thin layers).

6.7.2 Associative Adsorption

In associative adsorption, a mixed surface is formed. The properties displayed by the surface are some sort of average properties.

A typical associative system may be a long alcohol (for instance decanol) and charged surfactants (for instance soaps). The alcohol acts as a spacer between the charged groups, which decreases the head-group repulsion within the layer and reduces the surface energy. This increases the adsorption and enhances the surface activity. Similarly, a lamellar phase is formed in the corresponding three-component phase diagram: water/sodium caprylate/decanol (Fontell, et al., 1968). Mixed layers are commonly formed due to associative adsorption with natural and technical emulsifier blends. This is also a necessary requirement of the common assumption that an average HLB value should describe the properties of an emulsifier blend (Davies, 1957). A common system assumed to act in this way is a mixture of sorbitan esters and ethoxylated sorbitan esters where the smaller sorbitan esters can use the space between the bulky ethoxylated esters (Boyd et al., 1976).

In the case of associative adsorption, both components are expected to be present in the surface. If this situation is to be stable, the adsorption of the second component should be either enhanced by the presence of the first component or at least not influenced by it. The total amount of adsorbed material should be greater than or equal to the sum of the two components.

6.7.3 Layered Adsorption



Adsorption in layers is possible when different classes of surface-active components are present in a mixture. See Table 6.9. The two components must be very different in character to give a structure with a layered character rather than a mixed layer. The second component adsorbs to a particle displaying the characteristic properties of the primary adsorbing emulsifier. This usually means a more hydrophilic surface, which can be expected to reduce the adsorbed amount. However, in some cases, the presence of certain groups increases the adsorption of specific substances.

The effects of the emulsifiers on protein adsorption is essential in most emulsifier applications in the food industry.

Ethoxylated surfactants usually give a strong reduction of protein adsorption. Courthaudon et al. (1991b) have shown $C_{12}EO_8$ totally displace all adsorbed β -casein from an emulsion system. Similar effects have also been obtained with emulsions formed with polysorbates (Dickinson and Tanai, 1992) and with monoglycerides (Hall and Pethica, 1967). On the other hand, egg yolk PC did not reduce the the adsorbed amount of β -casein more than about 20% (Courthaudon et al., 1991a).

The adsorption of a range of plasma proteins at various phospholipid surfaces has been characterized using ellipsometry (Malmsten, 1995). A large variation of the adsorbed amount was obtained, depending on the combination of protein and phospholipid. Purified PC and PE gave low adsorbed amounts, while phosphatidic acid enhanced the adsorption of fibrinogen with a factor of 5 compared to a bare hydrophobic surface.

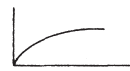
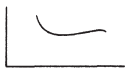
Table 6.9 The apparent emulsifier layers for various emulsifiers estimated from equation (From Östberg et al., 1995)

Emulsifier cone (%) ^a	Radius (µm) ^b	Emulsifier-layer thickness (Å) ^c	Curve shape ^d	Estimated length of the emulsifier (Å) ^e
Dodecylbenzenesulfate				
0.1	0.47	1.6		15
Fatty acid monoethanolamid ethoxylate (7EO)				
10	0.27	90		54
Fatty acid monoethanolamid ethoxylate (13EO)				
7	0.20	45		75
Fatty acid monoethanolamid ethoxylate (18EO)				
10	0.23	59		93

^aThe emulsifier concentration calculated on the oil phase

^bThe radius is shown as $D(3, 2)/2$

^cThe apparent emulsifier layer, estimated assuming that all emulsifier is estimated at the interface.

^dThe curve shape shows the dependence for the apparent emulsifier layer of the emulsifier concentration

^eThe estimated length of the emulsifier molecule is estimated from the chemical formula or from measurements in the corresponding lamellar phase

References

- Arvidsson, G. et al. (1985). *Eur. J. Biochem*, 152, 753–9.
- Bancroft, W.D. (1913). *J. Phys. Chem.*, 17, 501.
- Bergenståhl, B. (1991). In *Food Polymers, Gels, and Colloids* (ed. E. Dickinson), Royal Society of Chemistry, London, pp. 123–131.
- Bergenståhl, B., Claesson, P. M. (1990). In *Food Emulsions* (eds. K. Larsson, S. Friberg), Marcel Dekker, New York.
- Bergenståhl, B., Fontell K. (1983). *Prog. Coll. Pol. Sci.*, 68, 48–52.
- Bergenståhl, B., Stenius P.J. (1987). *Phys. Chem.*, 91, 5944–48.
- Boyd, J. V. et al. (1976). In *Theory and Practice of Emulsion Technology* (ed. A. L. Smith), Academic, London.
- Caffrey, M. (1985). *Biochemistry*, 24, 4826–44.
- Courthaudon, J. L. et al. (1991a). *J. Agr. Food Chem.*, 39, 1365.
- Courthaudon, J. L. et al. (1991b). *J. Colloid Interface Sci.*, 145, 390.
- Darling, D., Birkett, R. J. (1987). In *Food Emulsions and Foams* (ed. E. Dickinson). Royal Society of Chemistry, London.
- Davies, J. T. (1957). *Proc. Intern. Congr. Surf. Activity*, 2d, London, 1, 426.
- Dickinson, E. (1986). *Food Hydrocolloids*, 1, 3.
- Dickinson, E., Tanai S. (1992). *Food Hydrocolloids*, 6, 163–71.
- Dickinson, E. et al. (1991). *Food Hydrocolloids*, 4, 403–14.

- Eriksson, P. O. et al. (1987). *Phys. Chem.*, 91, 846–63.
- Eriksson, P. O. et al. (1985). *Chem. Phys. Lipids*, 37, 357–71.
- Fontell, K. (1978). *Progr. Chem. Fats Other Lipids*, 16, 145–62.
- Fontell, K. et al. (1968). *Acta Polytechnica Scandinavica, Chapter 2, Chemistry Series III*, 74, 2.
- Friberg, S. (1990). In *Food Emulsions* (eds. K. Larsson, S. Friberg), Marcel Dekker, New York.
- Friberg, S. (1971). *J. Colloid Interface Sci.*, 37, 291.
- Friberg, S., Mandell, L. (1970a). *J. Assoc. Off. Chem. Soc.*, 47, 149.
- Friberg, S. (1970b). *J. Pharm. Sci.*, 59, 1001–4.
- Friberg, S. Rydhag, L. (1971). *Kolloid Z. u. Polymere*, 244, 233–9.
- Friberg, S. Wilton, I. (1970). Liquid crystals—the formula for emulsions, *Am. Parf. and Cosm.*, 85, 27–30.
- Friberg, S. et al. (1969). *J. Colloid Interface Sci.*, 29, 155–6.
- Gawrish, K. et al. (1992). *Biochemistry*, 31, 2856–64.
- Griffin, W. C. (1979). In *Kirk-Othmer Encyclopedia of Chemical Technology*, Vol. 8 Wiley, New York.
- Griffin, W. C. (1949). *J. Soc. Cosmetic Chemists*, 311–26.
- Hall, D.G., Pethica, D.A. (1967). In *Nonionic Surfactants* (ed. M.J. Schick), Marcel Dekker, New York, p. 516.
- Inoko, Y., Mitsui, T.J. (1978). *Phys. Soc. Jap.*, 44, 1918.
- Israelachvili, J. (1992). *Intermolecular and Surface Forces*. Academic, London.
- Israelachvili, J. et al. (1977). *Biochim. Biophys. Acta*, 470, 185–201.
- Israelachvili, J. et al. (1976). *J. Chem. Soc. Faraday Transactions 11*, 72, 1525.
- Janiak, M.J. et al. (1979). *J. Biol. Chem.*, 254, 6068–78.
- Krog, N. (1990). In *Food Emulsion* (eds. K. Larsson, S. Friberg), Marcel Dekker, New York, p. 127.
- Kronberg, B. (1983). *J. Colloid Interface Sci.*, 96, 55–68.
- Kunieda, H., Ishikawa, N. (1985). *J. Colloid Interface Sci.*, 107, 122–28.
- Kunieda, H. Shinoda, K. (1985). *J. Colloid Interface Sci.*, 107, 107–21.
- Larsson, K., Krog, N. (1973). *Chem. Phys. Lipids*, 10, 177.
- Lindblom, G. et al. (1991). *Biochemistry*, 30, 10938–48.
- Malmsten, M. (1995). *J. Colloid Interface Sci.*, 172, 106–15.
- Östberg, G. et al. (1995). *Colloid Surfaces A. Physicochemical Engineering Asp.*, 94, 161–71.
- Pezron, I., et al. (1991). *J. Colloid Interface Sci.*, 144, 449–57.
- Rydhag, L. (1979). *Fette Seifen Anstrichm.*, 81, 168–73.
- Rydhag, L. Wilton, I. (1981). *J. Assoc. Off. Chem. Soc.*, 58, 830–7.
- Shinoda, K., Friberg, S. (1986). *Emulsions and Solubilization*, Wiley, New York.
- Shinoda, K., Kunieda H. (1983). In *Encyclopedia of Emulsion Technology*, Vol. 1 (ed. P. Becher), Marcel Dekker, New York.
- Shinoda, K., Saito, H. (1968). *J. Colloid Interface Sci.*, 30, 258–63.
- Small, D. M. (1986). *Handbook of Lipid Research: Physical Chemistry of Lipids*, Plenum, New York.
- Söderberg, I. (1990). Structural Properties of Monoglycerides. Phospholipids and Fats in Aqueous Systems, *PhD Thesis*, University of Lund, Sweden.
- Tanford, C. (1973). In *The Hydrophobic Effect*, Wiley, New York.
- Walstra, P. (1983). In *Encyclopedia of Emulsion Technology*, Vol. 1 (ed. P. Becher), Marcel Dekker, New York, p. 57.
- Walstra, P. (1988). In *Gums and Stabilizers for the Food Industry*, Vol. 4 (eds. G.O. Phillips et al.). IRL Press, Oxford, pp. 233–336.
- Westesen, K., Wehler, T. (1992). *J. Pharm. Sci.*, 81, 777.
- Wilton, I., Friberg, S. (1971). Influence of temperature-induced phase transition in fat emulsions. *J. Assoc. Off. Chem. Soc.*, 48, 771–4.

Chapter 7

Emulsifiers in Dairy Products and Dairy Substitutes

Stephen R. Euston

7.1 Introduction

Bovine milk has been an important source of food for human beings for thousands of years. Not only is milk a very nutritious food in its own right, but it is also a very versatile starting point for many other dairy products.

Milk is a complex food emulsion and colloidal sol. Table 7.1 gives the composition of whole cow's milk. The emulsion is composed of fat droplets dispersed in an aqueous phase containing protein. The protein is in the form of both casein micelles, which are themselves colloidal particles, and free in solution as whey protein. A considerable reserve of knowledge has been assembled on the structure and properties of milk proteins (Swaisgood, 1992). The fat droplets are stabilized by an adsorbed layer of protein and phospholipid called the 'milk fat globule membrane' (MFGM), which is distinct from the aqueous phase protein (Walstra & Jenness, 1984). The average composition of the MFGM has been estimated to be about 48% protein, 33% phospholipid, and 11% water, with the remainder made up of other minor lipid components (Walstra & Jenness, 1984). The phospholipid fraction of the membrane is composed of lecithin, phosphatidyl ethanolamine, phosphatidyl serine, phosphatidyl inositide, plasmalogens and sphingomyelin. Phospholipids are important food emulsifiers in their own right. The contribution that they make to the stability of the milk fat globule is not well understood, but their use as food-grade emulsifiers has been the subject of extensive fundamental research (Courthaudon et al., 1991; Dickinson et al., 1993a; Dickinson & Iveson, 1993).

Because of its biological origin, milk is particularly susceptible to microbial and physical deterioration. This severely limits the shelf-life of raw milk. To overcome this milk can either be heat treated to kill bacteria or converted to other products that are more stable due to a decrease in pH, lowered water activity or the presence of salt. Until this century the conversion of milk to butter, cream, ice cream, and various types of cheese had been more of a craft than a science. It is only relatively recently that an albeit incomplete understanding of these processes has been available. It is now understood that the formation of these milk-based products is a consequence of either the destabilization of the dispersed-phase fat droplets (as in butter, ice cream and whipped cream) or of the dispersed aqueous-phase proteins (as in cheese).

Table 7.1 Approximate composition of bovine milk

Component	Average content (wt%)	Range (wt%)	Average dry matter (%)
Water	87.3	85.5–88.7	–
Solids, non-fat	8.8	7.9–10.0	69.0
Fat in dry matter	32.0	21.0–38.0	–
Lactose	4.6	3.8–5.3	36.0
Fat	3.9	2.4–5.5	31.0
Protein	3.25	2.3–4.4	26.0
Casein	2.6	1.7–3.5	20.0
Mineral substances	0.65	0.53–0.80	5.1
Organic acids	0.18	0.13–0.22	1.4
Miscellaneous	0.14	–	1.1

From Walstra and Jenness (1984), Reprinted by permission of John Wiley & Sons, Inc.

To control the structure and stability of these products, the manufacturer can add a range of permitted additives that can be either naturally occurring or artificial. One of the most versatile of these additives are the low molecular weight emulsifiers.

In the following pages, the major emulsifier-containing dairy and imitation dairy products will be reviewed. A brief description of their production will be given where relevant, with emphasis on the role that emulsifiers play in the formation and stability of the product.

7.2 Ice Cream

Ice cream is probably the most complex food that we encounter. In addition to its scientific complexity, ice cream also has a complex history. Ancient texts confirm that ice has been used to cool beverages and foods for 4000 years. During this time several examples of cooled desserts have appeared. Production of a product closer to modern ice cream requires lower temperatures than possible by cooling with ice alone. In Europe this had to wait until the fifteenth or sixteenth centuries when the knowledge (long known to Arab scientists) that a mixture of ice and salt could be used to produce sub zero temperatures was acquired from the East. It wasn't until the nineteenth century that ice cream became available to all but the aristocracy in Europe, and until the twentieth century that mass production started.

Ice cream is both a foam and an emulsion, and it contains ice crystals and an unfrozen aqueous phase whose freezing point is depressed by freeze concentration of salts, sugars, and polysaccharide stabilizers (Clarke, 2005). Despite its obvious complexity, ice cream has been widely studied, and much is known about the formation of its structure and the role that low molecular weight emulsifiers play in this (Govin & Leeder, 1971; Lin & Leeder, 1974; Goff, 1988; Krog & Barfod, 1990; Barfod et al., 1991). A typical ice cream formulation is shown in Table 7.2.

Ice cream manufacture is a relatively simple process. The ingredients are mixed, heated to destroy pathogens, and then homogenized. The homogenization step is

Table 7.2 A representative composition of ice cream

Constituent	Weight percent in ice cream
Fat	10.0
Milk solid, non-fat	11.0
Sugar	13.0
Stabilizer	0.2
Emulsifier	0.5
Water	65.3

Based on Rosenthal (1991), *Milk and Dairy Products, Properties and Processing*

included to reduce the fat droplet size so that churning of the fat does not occur upon whipping. An in-line pasteurization step is then carried out prior to cooling to 4 °C and ageing of the mix at this temperature for at least 4 h. During this time milk proteins are able to redistribute between the fat surface and the aqueous phase and fat crystallization occurs. The ice cream mix is then aerated and froze in a continuous freezer. Freezing is completed by hardening the packed ice cream at minus 18 °C initially, and finally at minus 25 °C (Arbuckle, 1986; Rosenthal, 1991; Varnan & Sutherland, 1994; Clarke, 2005).

An acceptable ice cream product can be made without the addition of low molecular weight emulsifiers. Goff and co-workers (Segall & Goff, 1999, 2002a,b) have demonstrated that ice cream with acceptable physical properties can be made in the absence of emulsifiers if a ‘two-phase process’ is used. In this process the fat is emulsified with some of the protein and water, and then combined with the rest of the water and aqueous phase ingredients just before freezing (Segall & Goff, 2002b). In comparison to ice cream made by a conventional process with emulsifiers, the product made using the two-phase process had a comparable level of fat destabilization and meltdown rate, but the overrun (degree of air incorporation) was lower.

It has been known for several years, however, that incorporation of emulsifiers into ice cream results in a product that whips more easily, is drier (a necessary requirement in moulded products), has improved melt-down resistance, and has a smoother body and texture (Arbuckle, 1986). In addition to this, the ice cream has a higher overrun, the air is more finely dispersed, and the foam structure is more stable if emulsifiers are present (Keeney, 1982). An understanding of the mechanism by which emulsifiers change these properties has emerged over the past few years (Goff, 1988; Krog & Barfod, 1990; Barfod et al., 1991). Before describing the role of emulsifiers in ice cream structure formation, it is pertinent to consider the structure of the adsorbed layer formed around the fat droplet in the ice cream premix emulsion, since this plays a large role in determining emulsion droplet stability, and hence the stabilization of ice cream foam. During the homogenization stage the ice cream mix is subject to high shear. This results in the disruption of the fat phase into small droplets. Surface-active components of the mix will adsorb onto the nascent-oil/water interface, lowering the interfacial tension and thus stabilizing the emulsion droplets.

Recent research has thrown light on the competitive adsorption between different milk proteins (Dickinson, 1986; Dickinson et al., 1988b, 1989a,c; Euston, 1989;

Dickinson et al., 1990b; Dickinson, 1992), milk proteins and emulsifiers (Dickinson & Woskett, 1988a; Dickinson et al., 1990a; Dickinson, 1992; Euston et al., 1995a,b), and on the competitive adsorption between proteins and polysaccharide stabilizers (Dickinson & Euston, 1990; Dickinson, 1992, 1993). These studies have identified that, in general, the more surface-active protein in a mixture will dominate the adsorbed layer initially, low-molecular weight emulsifiers will, generally, displace protein from the surface with time, and under certain conditions polysaccharides can interact with proteins and/or emulsifiers to contribute to the structure of the adsorbed layer (Bergentahl et al., 1992). The adsorbed layer of the ice cream emulsion will be a composite of all of these functional ingredients.

The key to the formation of ice cream structure is the formation of a stable foamed product. In ice cream this is achieved in two ways. The foam in ice cream is not a typical protein-stabilized foam, where air bubble stabilization is achieved by protein adsorption at the air/water interface. The initial stabilization of the foam network may indeed proceed by this mechanism, but prior to freezing the foam structure is stabilized primarily by the partial coalescence of emulsion droplets at the air bubble interface, in combination with an adsorbed layer of emulsifiers and protein. Figure 7.1 is a cryo-SEM micrograph of ice cream. Adsorption of fat

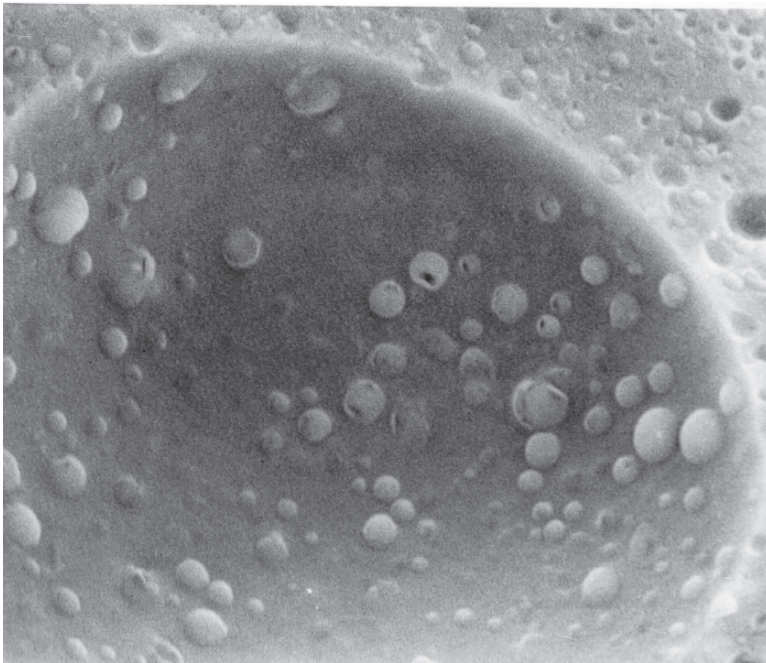

Fig. 7.1 Cryo scanning electron micrograph of a foam bubble in ice cream. Note the partial coverage of the air bubble surface by fat globules. Fat globules can also be seen in the foam lamellae outside of the droplet. (Reproduced by kind permission of Prof. D. Goff, Dept. of Food Science, University of Guelph.)

globules at the air bubble surface is clearly visible, although these do not cover the whole surface of the air bubble. For fat globule adsorption to occur, the emulsion must be relatively unstable to the shearing forces exerted on the mix during air incorporation. Several workers have attempted to demonstrate the link between emulsion coalescence stability and the mechanical or viscoelastic properties of the adsorbed protein layer (Doxastakis & Sherman, 1984; Rivas & Sherman, 1984; Dickinson & Stainsby, 1988; Dickinson et al., 1988a). Dickinson et al., 1988a have shown a correlation between the surface shear viscosity of adsorbed layers of various proteins at the planar oil/water interface, and the coalescence stability of emulsions made with these proteins. The higher the interfacial viscosity, the more stable the resultant emulsions under perikinetic conditions. It has also been demonstrated that the orthokinetic stability of protein-stabilized emulsions (stability under turbulent or shearing conditions) is reduced by the presence of low molecular weight emulsifiers (Chen et al., 1993a; Dickinson et al., 1993; Dickinson & Williams, 1994). The explanation for this lies in the ability of the low molecular weight emulsifier to displace protein from the fat-droplet surface, thus reducing the mechanical strength of the adsorbed layer. Emulsifiers present at concentrations too low to cause significant protein displacement can interfere with inter-protein interactions within the adsorbed layer and reduce the interfacial viscosity in this way (Dickinson et al., 1990a).

Emulsifiers that have an improving effect on the structure of ice cream do so because they are able to aid in the destabilization of the milk protein-stabilized ice cream emulsion. Emulsifiers commonly used in ice cream mix such as glycerol monostearate (GMS) and polysorbates, destabilize the emulsion by displacing protein from the fat-droplet surface. This is a result of their greater surface activity than milk proteins. Zhang and Goff (2005) have studied the composition of the air bubble interface in ice cream in the presence of either saturated (GMS) or unsaturated (GMO) monoglycerides. They found that in ice cream emulsions made using skim milk powder as the protein source that both emulsifiers were able to displace protein from the surface. However, GMO appeared less able to displace the milk whey protein β -lactoglobulin than did GMS. Davies et al. (2000, 2001) have also highlighted the importance of emulsifier type in their study of the effect of glycerol monoleate (GMO), glycerol monopalmitate (GMP) and glycerol monostearate (GMS) on the shear stability of protein stabilized emulsions. They found that the order of coalescence of the sheared emulsions decreased in the order $GMO > GMP > GMS$. This affect was attributed to both differences in the ability of the emulsifiers to displace protein from the interface, and to differences in the morphology of fat crystals in the emulsions droplets. The latter effect, which occurs because emulsifiers can influence the crystal structure of the fat in the droplets, is discussed in more detail below. Davies et al. also found, however, that the emulsifier type that gave the highest degree of shear-induced destabilization was also relatively unstable under quiescent conditions. To achieve a balance between good quiescent stability and susceptibility to shear induced partial coalescence, they found that a combination of GMO and GMS, or GMO and GMP was required (Davies et al., 2001).

Several studies have shown that the surface activity of emulsifiers is strongly temperature-dependent. Studies on model systems (Dickinson & Tanai, 1992) and in ice cream mix (Krog & Barfod, 1990; Barfod et al., 1991) indicate that displacement of protein from the oil/water interface by emulsifiers is at a maximum at temperatures between 4 °C and 10 °C. This observation provides an explanation for the improvement in ice cream structure and stability imparted by the ageing process. It is during the ageing step at 4 °C in ice cream manufacture that the displacement of the majority of the protein occurs. Krog and Barfod and co-workers (Krog & Barfod, 1990; Barfod et al., 1991) have investigated the ageing effect in ice cream emulsions and have shown that whereas protein displacement does occur during ageing in the absence of emulsifiers, displacement is greater when GMS is present, and greater still when glycerol monooleate is added (Fig. 7.2).

The temperature dependence of emulsifier surface activity can be explained in terms of the phase behaviour in aqueous solution. In the bulk phase, emulsifiers exhibit a phase behaviour similar to that of triglycerides (Krog & Sparsø, 2005). That is, they can exist in two polymorphic forms, α and β forms, that differ in the way the molecules pack in the crystal structure. When cooled from a random molten state, a metastable crystalline structure termed the α -state is formed. Further cooling leads to a transition to the β state. The most stable β -crystalline structure will form if the α -state is stored at ambient temperature. Lutton et al. (1969) proposed that the temperature dependence of GMS surface activity can be explained by either the formation of a condensed crystalline monolayer at the oil/water interface

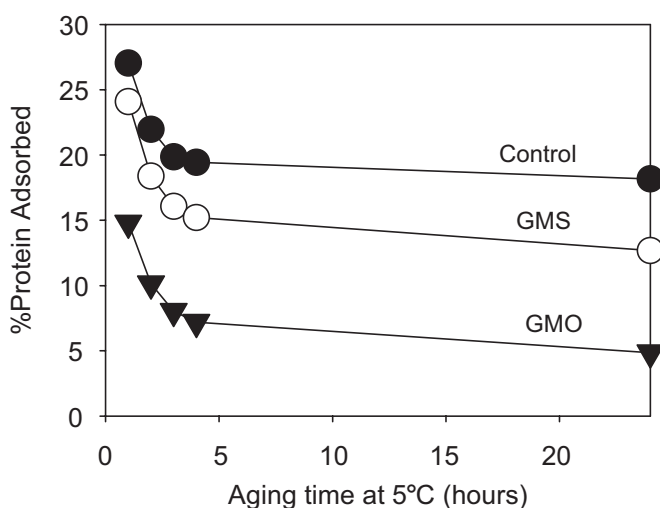

Fig. 7.2 Changes in amount of protein adsorbed to fat globules in an ice cream mix during the ageing period at 5°C. The amount of protein bound in the fat phase is calculated relative to the total protein in the mix. (From Krog and Barfod, 1990. Reproduced with permission of the American Institute of Chemical Engineers, © AIChE. All rights reserved.)

at 5 °C or by micelle formation close to the surface. The possibility that both mechanisms contribute to the increased activity on cooling cannot be ruled out.

Monoglycerides, and indeed other emulsifiers, have also been shown to exhibit complex liquid crystalline phase behaviour in aqueous solution (Krog & Sparsø, 2005). Under certain conditions, the β -crystal form of a monoglyceride will interact with water to form a lamellar liquid crystal. On cooling this can transform to a so-called α -gel phase (Krog & Sparsø, 2005). It has been hypothesized that phase transitions between different crystalline and/or liquid crystalline forms of the adsorbed monoglyceride are important in protein displacement (Berger, 1990). During homogenization the temperature of the ice cream mix is high (80 °C). Protein and emulsifier will both occupy the surface, with the emulsifier having a relatively small effect on the protein surface coverage. As the mix is cooled for ageing, it is possible that a water-containing lamellar liquid crystalline phase of the emulsifier is formed, which subsequently transforms into the α -gel phase. This latter transformation is accompanied by the uptake of large quantities of water. At a later stage the more stable β -crystalline state may be formed. Berger (1990) believes that the two transformations, lamellar to α -gel, and α -gel to β -crystal, play a role in protein displacement. The change from a lamellar to a gel phase results in a decrease in surface area of about 30%, and formation of the β -crystal structure releases large amounts of water (Berger, 1990). On their own, each of these transitions will disrupt the adsorbed protein layer, and in combination they may be the cause of protein displacement. Darling and Birkett (1987), however, believe that in ice cream insufficient emulsifier is present in the system for liquid-crystalline phases to form. For this to occur the emulsifier must be adsorbed on the fat droplet surface at a concentration far greater than that required for monolayer surface coverage. This is not the case in ice cream emulsions (Darling & Birkett, 1987).

Once the emulsion has been destabilized in the freezer, partial coalescence of the fat droplets has to occur at the air/water interface to partially stabilize the foam structure prior to freezing. Research has indicated that the crystal structure of the fat in emulsion droplets is important in determining their susceptibility to partial coalescence (Boode, 1992; Boode & Walstra, 1993). Van Boekel (1980) has shown that when fat crystals form at the surface of emulsion droplets, and are large enough to penetrate the adsorbed layer, a lipid bridge can form between two droplets that are in contact with each other. The proportion of solid fat in emulsion droplets is important in determining instability (Walstra, 1987). If the majority of the fat is solid, coalescence, or partial coalescence will not occur, and the droplets will be stable. Similarly, if the droplets contain a very low proportion of solid fat, coalescence can occur, which leads to emulsion coarsening. If the solid fat content is in the approximate range 10–50%, partial coalescence is possible. A proportion of the emulsion droplet is required to be in the form of liquid fat for partial coalescence to occur. Walstra (1987) envisages a partial coagulum of fat droplets as being held together by necks of liquid oil.

Liquid fat is also considered to play a role in the adsorption of fat globules at the air bubble surface. The favoured view has been that during air incorporation, collisions between air bubbles and emulsion droplets lead to rupture of the fat globule,

which releases free fat that then spreads over the air bubble surface. This helps to anchor the droplets at the interface and helps to stabilize the bubble. Recent studies by Goff et al. (1999), however, have challenged this view. Using microscopy techniques, they studied the air bubble surface at differing degrees of fat destabilization onto the surface. This was achieved using differing levels and types of emulsifier, combined with different processing regimes. They found no evidence that free fat covers the whole air-bubble surface, even at the highest level of fat droplet destabilization which leads to the highest coverage of the air bubbles by fat droplets.

When fat crystallizes in dispersed emulsion droplets, considerable supercooling can be observed. Crystallization of fats occurs at nucleation points that already exist in the fat phase. These nucleation points occur relatively infrequently in emulsion droplets where the fat is dispersed into a large number of small droplets. Consequently, in dispersed systems the triglyceride needs to be cooled below its bulk phase freezing point before crystallization is initiated. Emulsifiers in adsorbed monolayers can act as templates for the surface crystallization of triglycerides. Emulsifiers containing saturated hydrocarbon chains have been shown to be good initiators of fat crystallization, whereas those with unsaturated hydrocarbon chains are not as good (Berger, 1990; Barfod et al., 1991). Figure 7.3 gives the solid fat content (SFC) as a function of time for model ice cream emulsions stored at 5 °C. Both saturated (GMS) and unsaturated (GMO) emulsifiers initiate crystallization compared to control emulsions with no emulsifier, but the SFC for GMS-containing emulsions is always greater than for those containing GMO.

Darling and Birkett (1987) point out that in a mixed triglyceride system, such as is found in milk fat, single discrete crystals are unlikely to form under the rapid cooling conditions used in ice cream manufacture. They have shown that in a cooled vegetable oil emulsion, concentric layers of triglyceride crystals are formed at the

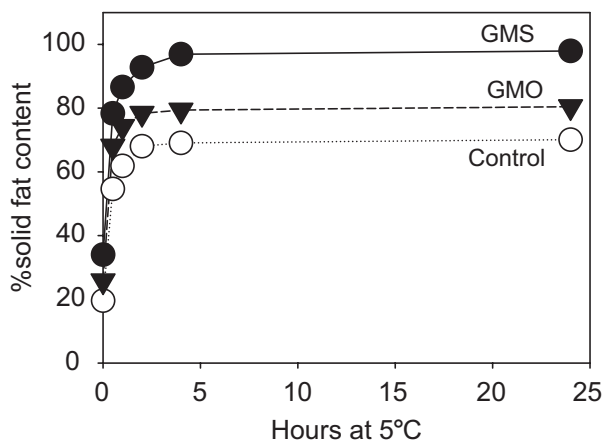

Fig. 7.3 Recrystallization of fat phase of ice cream emulsions without emulsifier (control) or with saturated (GMS) or unsaturated (GMO) monoglycerides after cooling to 5°C and aging. (From Barfod et al., 1991. Reproduced with permission.)

surface of droplets. These contain imperfections that may be due to dislocations or recrystallization processes, and these are likely to cause the destabilizing effect.

The ability of triglyceride crystals to penetrate the adsorbed layer depends on a number of factors. The surface tension between crystal and oil, crystal and water, and oil and water will determine how far into the oil phase the crystal will penetrate (i.e. if it is preferentially wetted by the oil or water phase). Emulsifiers, by way of their surface activity, will alter these surface tensions, and this may result in the crystals being able to penetrate further into the aqueous phase. This would lead to a decrease in emulsion stability. Desorption of protein by emulsifier also aids destabilization by reducing the thickness of the layer through which fat crystals have to penetrate. The polymorphic form of fat crystals will also play a role in fat-droplet instability. Triglycerides can exist in three general polymorphic forms, the α , β and β' polymorphs. When cooled from the melt, triglycerides will generally form α -type crystals. These are not stable (Larsson & Dejmek, 1990) and will transform into a β' polymorph and subsequently to the stable β polymorph. Having been formed at lower temperature, α crystals contain triglyceride in a more disordered liquid-like arrangement. The disordered crystals are softer and are able to deform and follow the contours of the fat droplet more easily. Consequently, they are less likely to penetrate the adsorbed layer. The β crystalline structure is more solid like, with the triglyceride molecules arranged in ordered arrays. The β crystals have a greater mechanical strength and are unable to deform to the shape of the fat droplets. This leads to their bursting out of the droplet into the aqueous phase (Darling, 1982).

In practice, two types of emulsifiers are commonly used in ice cream: mono- and diglycerides and polyoxyethylene derivatives of glycol or glycol esters, for example polysorbates (Keeney, 1982). Sucrose esters have also been evaluated and have been found to be suitable as ice cream emulsifiers (Buck et al., 1986). Mono- and diglycerides and polysorbates are usually all found in current ice cream emulsifier blends. The explanation for this lies in the relative abilities of polysorbates and mono- and diglycerides as emulsion destabilizers, or as foam-forming agents. Polysorbates are far more efficient at displacing protein from the oil/water interface than are mono- and diglycerides and thus are better emulsion destabilizers (Keeney, 1982). Mono- and diglycerides are better foaming agents and thus are able to aid the formation of the initial foam prior to fat-droplet agglomeration at the air/water interface (Keeney, 1982). A second factor is the differing abilities of emulsifiers to influence fat crystallization. Figures 7.2 and 7.3 show that whereas GMO is able to displace more protein from the fat globule surface during ageing than does GMS, GMS initiates more fat crystallization than GMO. Use of a mixed emulsifier system would also allow optimum protein displacement combined with optimum fat crystallization.

In summary, non-protein emulsifiers are important in ice cream in several respects:

1. They promote protein desorption from the surface of fat droplets, both by their higher relative surface activity and the possible formation of liquid crystal mesophases.
2. They can act as nucleation points for surface crystallization of triglycerides.

3. They may promote fat crystal penetration of the adsorbed layer by alteration of the surface tension between various phases.
4. They may help in the initial formation and stabilization of the ice cream foam prior to partial fat globule coalescence and freezing. Monoglycerides are particularly good at this function.

7.3 Whipped Cream and Whipping Cream

The terms whipping cream and whipped cream are often used interchangeably, although there are obvious differences between the two both in terms of structure and stability. Whipping cream is an oil-in-water emulsion stabilized by adsorbed milk protein and (where added) low molecular weight emulsifiers. Whipped cream is formed from whipping cream when air is incorporated into the emulsion to form a foam.

Whipping cream can be made by concentration of the milk fat globules found naturally in milk, or by a recombination process where amorphous milk fat is homogenized with milk proteins and low molecular weight emulsifiers. The fat content of whipping cream is about 35% by weight. Unlike ice cream emulsion, which only has to be stable long enough to be aged for a few hours before processing into ice cream, whipping cream emulsion has to be stable enough to allow storage for several weeks at ambient temperature, if UHT processed, without appreciable loss of stability.

The structure of whipped cream resembles that of ice cream in some ways. The foam is stabilized, initially by adsorbed protein and any added emulsifier. Prolonged whipping of the cream leads to partial agglomeration of fat globules at the air/water interface of foam bubbles. Whereas in ice cream the final structure is partially stabilized by fat globule adsorption at the air bubble surface, but mostly by freezing of the aqueous phase, in whipped cream the higher dispersed-fat phase content (35 wt% compared to about 10 wt% in ice cream) leads to a higher degree of fat-particle coalescence at the air/water interface. This greater fat adsorption leads to formation of a stable foam without the need for freezing. In addition, the fat globules aggregate in the aqueous phase of the cream to form a continuous, semi-solid gel-like network structure that traps the air bubbles and prevents them from coalescing. Figure 7.4 is a cryo-SEM micrograph showing fat-globule adsorption at the air/water interface in whipped cream, and the structure of the partially coalesced fat matrix in the foam lamellae. Comparing this to Fig. 7.1, a cryo-SEM of ice cream, it is apparent that the degree of fat-globule adsorption is less in ice cream. The adsorbed fat globules contribute to the rheological properties of the foam. By influencing drainage in the aqueous lamellae between air bubbles, the partially coalesced, adsorbed fat globules impart a small but finite yield stress on the whipped product (Dickinson & Stainsby, 1982). This allows whipped cream to 'stand up' under its own weight even at ambient temperature.

Non-homogenized cream separated from milk will whip satisfactorily without the addition of emulsifiers. If the cream is homogenized prior to whipping and the

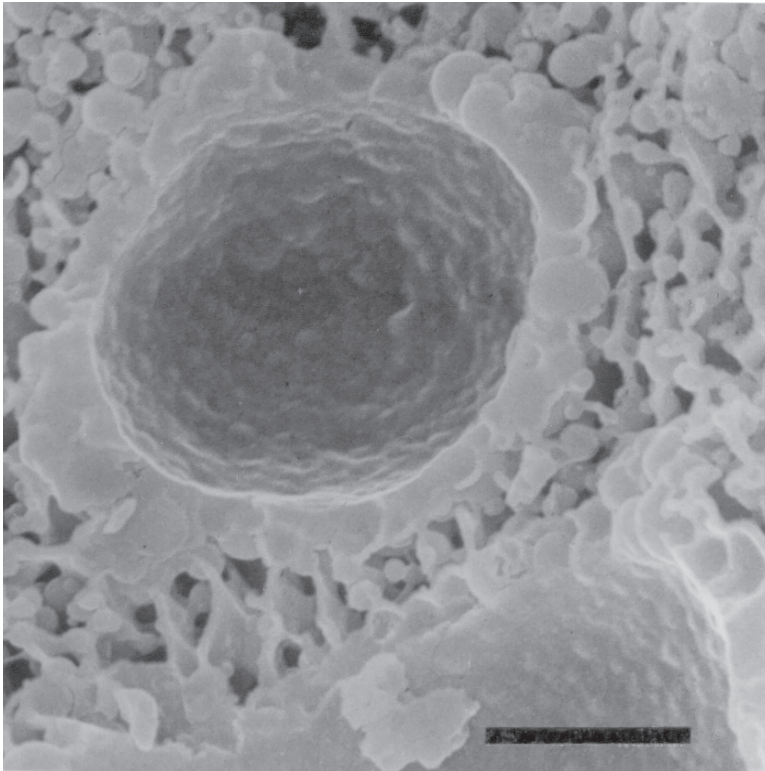

Fig. 7.4 Cryo-scanning electron micrograph of whipped cream. Note the greater coverage of the air bubble surface by fat globules than occurs in ice cream. The partially coalesced fat globule network that gives cream its semi-solid structure is also clearly visible. (Reproduced by kind permission of Prof. D. Goff, Dept. of Food Science, University of Guelph.)

mean fat globule size reduced, emulsifiers have to be added to aid destabilization. Anderson and Brooker (1988) have attributed the differences in whipping ability of homogenized and non-homogenized cream to the differences in interfacial composition of the emulsion droplets in these systems. Non-homogenized cream contains fat globules stabilized by native MFGM. The composition of this has been described earlier (see Sect. 7.1). After homogenization, the particle size is reduced, interfacial area is increased, and consequently, MFGM on its own is insufficient to stabilize the newly formed interface. A combination of increased interfacial area and competitive adsorption between MFGM and cream serum proteins means that proteins from the aqueous phase (caseins and whey proteins) contribute to the interfacial layer. The interfacial layer in homogenized cream has been found to consist mainly of caseins, with smaller amounts of β -lactoglobulin and α -lactalbumin (Anderson et al., 1977; Darling & Butcher, 1978; McPherson et al., 1984). This is consistent with the available data on competitive adsorption between casein and whey proteins

in model systems (Euston, 1989; Dickinson et al., 1990b). In the early stages of whipping, before fat-globule adsorption and partial coalescence occur to any great extent, the air bubbles are stabilized by adsorbed milk serum proteins. Since this air/water interface is composed of the same proteins that surround the fat/water interface in homogenized cream, the difference in interfacial tension between the two interfaces is not that great (Anderson & Brooker, 1988). The interfacial tension differences is a driving force for fat-globule adsorption at the air/water interface in both cream and ice cream, and if this is low or negligible, fat globule adsorption is reduced. In non-homogenized milk the interfacial tension differences between a fat globule stabilized by MFGM and an air bubble stabilized by cream serum proteins are sufficient to act as the driving force for fat-globule adsorption at the surface of air bubbles. Of course this is also aided by the presence of fat crystals at the fat-globule surface and by the shearing forces introduced during whipping.

The importance of the fat phase manifests itself in two ways. As in ice cream (see Sect. 7.2), fat crystals are known to be important in the shear-induced coalescence of the fat globules (Darling, 1982), and the presence of a certain amount of liquid fat is a pre-requisite for good whipping properties. Bucheim (1986) put forward the idea that the interfacial layer surrounding the fat droplets ruptures when they collide during agitation. The subsequent spreading of liquid fat is the first stage in destabilization by aggregation of adjacent droplets. The importance of the solid fat content of the fat globules has been demonstrated by Darling (1982), who observes a direct correlation between the SFC and whipping time in natural cream.

Recombining technologies are becoming an increasingly important process for making whipping cream bases. These encounter the same problems as homogenized cream (i.e. the similarity in composition and interfacial tension between air/water and oil/water interfaces), if they are formulated with milk proteins as the only surface-active material. For this reason, recombined whipping creams, and indeed homogenized natural creams contain added low molecular weight emulsifiers. These adsorb at, and alter the composition of the fat-droplet surface, thus changing the interfacial tension. Addition of an optimum concentration of emulsifiers results in an oil/water interface composed of protein and emulsifier differing sufficiently from the air bubble interface for fat-globule adsorption to occur on whipping. For similar reasons to those proposed for ice cream (see Sect. 7.2), whipping cream emulsifiers are usually a combination of two types. There is often a lipophilic emulsifier such as GMS, or one of its derivatives, and a water-soluble polyoxyethylene derivative such as one of the Tweens. Thomé and Eriksson (1973) have shown that the amphoteric phospholipids are good emulsifiers in whippable emulsions when used in combination with monoglycerides. This is a significant observation when the trend toward natural, non-synthetic emulsifiers is considered. Phospholipids are a natural component of milk fat and can be produced as a by product when milk is processed into, for example, butter. This can explain the increasing use of butter-milk powders as combined emulsifier/protein systems in whipped emulsions (Vodickova & Forman, 1984).

The structure of the composite fat-globule surface layer in homogenized and recombined dairy whipping cream is not known for certain. Two theories have been

put forward. Krog (1977) maintains that a primary layer of emulsifier adsorbs at the fat-droplet surface, and that a secondary protein layer is attached to the primary layer through relatively weak co-operative hydrogen bonding. When the cream is whipped this protein layer is removed from the fat globule relatively easily, and the emulsion destabilized in this way. Doxastakis and Sherman (1984), however, have evidence that the protein and emulsifier form a mixed interface where both are adsorbed through hydrophobic interaction with the interface. It is speculated that this can lead to localized differences in the interfacial tension at the fat-droplet surface (i.e. between protein rich and emulsifier-rich regions of the adsorbed layer) which helps to drive fat-globule adsorption and partial coalescence. Whichever of these theories is correct, it is also likely to be relevant to the destabilization of ice cream emulsion when it is frozen and whipped.

A stable whipped cream can be formed from whipping cream that has been held at room temperature for some time. However, a superior product is obtained if the cream is aged for several hours at low temperature prior to whipping. This, as in ice cream, is a consequence of increased emulsifier surface activity at a low temperature.

It would appear, therefore, that the functions of emulsifiers in whipping cream are essentially the same as for ice cream, i.e.

1. They destabilize the cream through their ability to displace protein from the oil/water interface. This changes the adsorbed layer composition and interfacial tension of the fat droplet.
2. They may destabilize the emulsion through their ability to form lyotropic liquid-crystalline mesophases and the subsequent phase transformations that occur to form stable crystalline forms.
3. They may participate in the initial foam stabilization.
4. They aid in the formation of fat crystals at the fat-droplet surface. These crystals are essential for fat-globule partial coalescence.

7.4 Whipped Toppings

Over the years, whipped toppings have become a popular alternative to dairy creams and ice cream. Table 7.3 gives a typical composition for whipped topping powder. In whipped toppings, as in dairy whipping creams, the emulsifiers appear to be

Table 7.3 Typical whipped topping powder composition

Ingredient	Composition (%)
Hardened coconut or palm kernel oil (melting point 31–36 °C)	32.0
Maltodextrin	32.0
Sodium caseinate	8.0
Emulsifiers	8.0

From Si (1991), Reprinted by permission of the Society of Dairy Technology

important in the destabilization of the emulsion, while the protein is important in giving initial stability to the oil-in-water emulsion. The mechanism by which emulsion destabilization is achieved, however, is different. Whereas whipped dairy creams and whipped imitation creams are stabilized by partially coalesced, relatively intact fat globules adsorbed at the air/water interface, whipped toppings are stabilized by crystalline fat at the air bubble surface. Krog and co-workers (Barfod & Krog, 1987; Bucheim et al., 1985; Krog et al., 1986) have carried out extensive studies of the factors that effect structure formation in whipped toppings. They have shown (Barfod & Krog, 1987) that part of the fat in spray-dried topping powders is in a supercooled state. When these topping powders are reconstituted in water at low temperatures, they show large structural changes that determine whipping characteristics and foam structure. The emulsion becomes unstable due to spontaneous recrystallization of the supercooled fat. The destabilization of the emulsion is probably promoted by the temperature-dependant desorption of protein from the surface, followed by coalescence. This makes crystallization of the supercooled fat more likely, due to the increased probability of nucleation sites (Bucheim et al., 1985).

Scanning electron microscopy studies (Bucheim et al., 1985) show that the final structure of the aerated whipped topping is stabilized by a layer of crystalline fat about 0.1 μm thickness. The aqueous phase lamellae between air bubbles also contain large proportions of crystalline fat, with smaller proportions of relatively intact fat globules.

The kinetics of fat crystallization and emulsion destabilization depend on the type of emulsifier used in the formulation. Si (1991) lists the type of emulsifier used in whipped toppings as propylene glycol esters of monoglycerides, acetic acid esters of monoglycerides, or lactic acid esters of monoglycerides. Bucheim et al. (1985) have investigated the effect of distilled propylene glycol monostearate (PGMS), distilled unsaturated monoglycerides (glycerol monooleate, GMO), and distilled saturated monoglycerides (glycerol monostearate, GMS) on the structure of whipped toppings. Only PGMS is typically used in commercial formulations. Figure 7.5 shows that all the emulsifiers promote fat crystallization when compared to toppings without added emulsifiers. The effect of PGMS and GMO, however, was greater than for GMS. The increased emulsion destabilization caused by the enhanced fat crystallization led to PGMS- and GMO-containing whipped toppings being more stable than those made from GMS-containing emulsions (Bucheim et al., 1985). The GMS-containing reconstituted topping emulsion is too stable to allow consequent stabilization of incorporated air (whipping).

The importance of protein desorption on whipped topping structure and stability has been demonstrated by Krog and co-workers (Krog et al., 1986; Barfod & Krog, 1987). Table 7.4 gives the percentage protein contents of the fat and aqueous phases of whipped topping powders reconstituted at 5 °C and 30 °C, and containing PGMS, GMS or no added emulsifier. At 5 °C in the absence of emulsifier almost one-quarter of the protein is associated with the fat phase. This falls to 1.7% when PGMS is present and 7.7% with GMS added. The temperature dependence of protein displacement is also evident. At 30 °C over 40% of the protein is in the fat phase when emulsifier is absent, but this drops to about 33.7% in the presence of PGMS and 12.35 when GMS is included in the formulation (Krog et al., 1986).

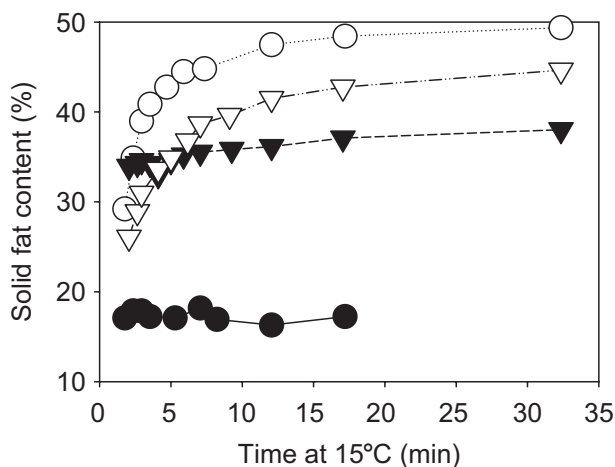

Fig. 7.5 Crystallization of supercooled lipid fractions in topping emulsions different surfactants, reconstituted (1:3) with deuterated water (D_2O), measured by pulsed-NMR at $15^\circ C$. ○ GMO (Dimodan O), PGMS (Promodan SP), ▽ GMS (Dimodan PV), • no surfactant added. (From Buheim et al., 1985. Reprinted by permission of Scanning Microscopy International.)

The GMS-containing reconstituted toppings have a significant proportion of protein still associated with the fat-droplet surface, even after ageing of the emulsions at $5^\circ C$. Obviously this is enough to form an adsorbed layer strong enough, in combination with the lower degree of fat recrystallization, to prevent stabilization of the incorporated air bubbles. This is in contrast to the situation in ice cream and whipping cream, where GMS is capable of destabilizing the fat emulsion to a degree that partial coalescence can occur. Darling and Birkett (1987) point out that the level of emulsifiers in whipped toppings is sufficient to allow the formation of emulsifier adsorbed layers of far greater than monolayer coverage. They suggest that the formation of liquid-crystalline mesophases, and the α -gel phase of the adsorbed emulsifier, is a possibility. Westerbeek and Prins (1991) have shown that a common emulsifier used in whipped toppings, glycerol lactopalmitate (GLP), is capable of forming the α -gel phase at oil/water interfaces, and this may contribute to emulsion destabilization.

Table 7.4 Distribution of protein between the fat cream phase and the water phase of centrifuged topping emulsion

Surfactant	After 1 h at $5^\circ C$		After 1 h at $30^\circ C$	
	% Protein in fat phase	% Protein in water phase	% Protein in fat phase	% Protein in water phase
10% PGMS	1.3	98.7	33.7	66.3
10% GMS	7.7	92.3	12.3	87.7
None	24.0	76.0	41.7	58.3

From Barford and Krog (1987), Reprinted by permission of the American Oil Chemists Society

The present understanding of the formation of structure in whipped toppings suggests the following mechanism for emulsion destabilization and formation of the foam structure:

1. The powdered dried topping emulsion is stable.
2. When reconstituted at low temperature, protein displacement is initiated and is aided by added emulsifiers such as PGMS. The mechanism of protein desorption will be similar to that already described for ice cream. There is an almost total desorption of protein from the fat droplet surface.
3. Coalescence of fat droplets can occur during whipping, due to the presence of liquid fat produced by supercooling.
4. Coalescence leads to a recrystallization of the supercooled fat, which is again aided by the presence of emulsifiers.
5. A continuous phase of elongated fat crystals is formed, resulting in an increased viscosity of the whip, which is capable of stabilizing dispersed air bubbles.

As in ice cream, the functions of emulsifiers in whipped toppings are to promote protein desorption and fat crystallization.

7.5 Cream Liqueurs

Cream liqueurs are dairy emulsions of high added value. The combination of milk protein-stabilized cream emulsion and high alcohol content make cream liqueurs unique among dairy emulsions. Table 7.5 gives a typical range of compositions for cream liqueur. In practice many commercial formulations also have small amounts of GMS added. The production of cream liqueurs is governed by the relative poorness of the alcoholic aqueous phase as a solvent for proteins and sugars. Two commercial processes are in common use (Banks & Muir, 1988), namely, the single-stage process and the two-stage process. Figure 7.6 presents flow charts for both processes. The main difference between the two processes lies in the stage at which the alcohol is added. In the single-stage process this is prior to homogenization, whereas in the two-stage process it is after homogenization. Banks and Muir (1988) found that homogenization in the presence of alcohol leads to the formation of fewer large fat globules, and as such is preferable in terms of emulsion stability. A characteristic of cream

Table 7.5 Range of compositions of a standard cream liqueur

Component	Composition (wt%)
Milk fat	12–16
Added sugars	15–20
Sodium caseinate	2.6–3.5
Non-fat milk solids	1.0–3.5
Ethanol	14
Water	46–51

Reprinted from Banks and Wislon (1981), with permission

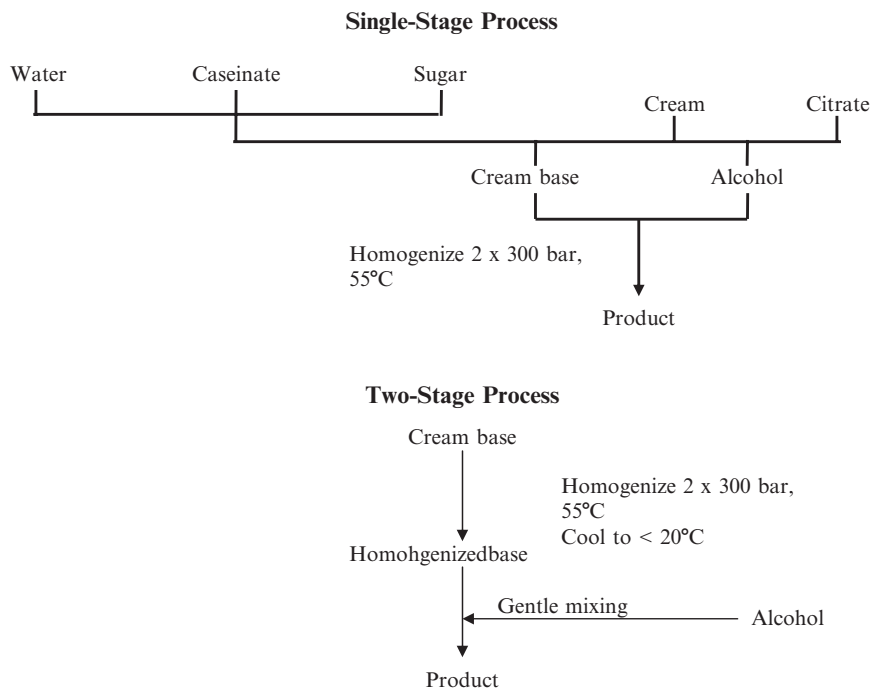

Fig. 7.6 Flow diagrams for the process of manufacture of a cream liqueur in (a) a single stage and (b) two stages. (From Banks and Muir, 1988. Reprinted by permission of Elsevier Applied Science Publishers.)

liqueur production is the harsh homogenization conditions used (two passes at 300 bar). This results in a product in which more than 97% of the fat droplets have a diameter less than 0.8 μm . A second factor favouring formation of smaller droplets is the significant lowering of interfacial tension observed at the oil/water interface when alcohol is added to the aqueous phase (Bullin et al., 1988; Dickinson & Woskett, 1988b; Burgaud & Dickinson, 1990). As a result of the very fine droplet size, the protein in the added cream has to be supplemented by sodium caseinate (to a fat-to-caseinate ratio of 5:1) to provide adequate coverage of the newly formed fat surface by protein (Banks & Wilson, 1981). The fine particle size of the dispersed phase fat droplets gives the product an excellent stability with respect to creaming. Banks and Wilson (1981) have noted no signs of creaming in liqueurs with a composition within the range quoted in Table 7.5 after 12 months storage. The high level of added sodium caseinate, however, leads to cream liqueur emulsions being unstable in acid environments. This means that they are not suitable for combination with acid beverage mixers such as lemonade. A cream liqueur that is stable in an acid environment can be made by replacing the sodium caseinate with GMS. The emulsifier replaces milk protein as the primary emulsion stabilizer at the oil/water interface, and the non-adsorbed protein is unable to aggregate the fat droplets when exposed to acidic

surrounding (Banks & Muir, 1988). Acid stability in this product is gained at the expense of emulsion stability and shelf life. In practice, legal limits in some countries set the concentration of GMS at no more than 0.4 wt%, and so total replacement of caseinate by GMS is not feasible. Many manufacturers add low concentrations of GMS as well as sodium caseinate to cream liqueur formulations. Dickinson et al. (1989b) have shown that, in addition to displacing some, but not all of the milk protein from the fat droplet surface, which presumably infers some acid stability on the product, GMS also improves the stability of a model cream liqueur. When model cream liqueurs were stored at room temperature for 12 weeks, no creaming was observed with added GMS concentrations above 0.5 wt%. Below this level of added GMS a reduced degree of creaming was observed compared to control samples with no emulsifier (Dickinson et al., 1989b). The increased stability was associated with rheological changes in the emulsifier aqueous phase. At low GMS concentrations the emulsions exhibit Newtonian behaviour, whereas above 0.5 wt% a yield stress is found. Dickinson et al. (1989b) postulate the formation of a weak gel-like network in the continuous phase formed by interaction of caseinate with GMS. It is also likely that interaction between caseinate and GMS at the oil/water interface plays a role in the creaming stability. Evidence for interactions between adsorbed caseinate layers and GMS has been reported by Doxastakis and Sherman (1984), who investigated the surface rheological properties of mixed caseinate GMS systems.

An apparent contradiction in the work of Dickinson et al. (1989b) is that although creaming stability is enhanced at GMS level above 0.5 wt%, the shelf life, as tested using an accelerated method at 45 °C, decreases in this region (Fig. 7.7). Dickinson et al. (1989b) point out that whereas weak gels are able to

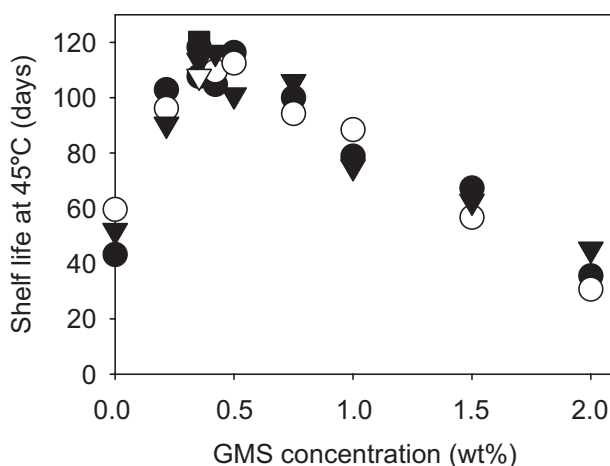

Fig. 7.7 Effect of GMS on the shelf life of simulated cream liqueurs on storage at 45°C. The time for serum separation to first become visible is plotted against the GMS concentration. Different symbols refer to separate experiments. (Based on Dickinson et al., 1989b. Reprinted by permission of the Institute of Food Technologists.)

prevent formation of a substantial cream layer, they are also prone to slow syneresis when stored for any length of time. This leads to separation of the aqueous phase and formation of a distinct, clear serum layer at the bottom of the sample container. Whether this syneresis will occur at room temperature is not certain, and Dickinson et al. (1989b) stress that a correlation between the shelf life at 45 °C and that at room temperature may not follow. Cream liqueurs stored under ambient conditions can have shelf lives of several years. Clearly these are likely to be consumed long before serum separation becomes evident. Since the legal limits on the amount of emulsifier are set at about 0.4 wt%, the problem of gel syneresis is unlikely to be encountered. At a level of 0.4 wt% added GMS, creaming under gravity would not be eliminated completely, but would be reduced to a level acceptable to the consumer (Dickinson et al., 1989b).

7.6 Creams and Coffee Whiteners

Cream products containing 10–20% fat have been popular as coffee creamers for over 50 years (Abrahamson et al., 1988). Coffee creamers and whiteners perform several functions: they give coffee a white colour, reduce bitter taste by complexation of the tannic acids with milk proteins, give the coffee a cream-like flavour, and give body to the coffee (Sims, 1989).

Traditionally, coffee cream is produced by simple concentration of milk up to the required fat content. The cream is usually heat treated using a UHT process, homogenized either before or after heating, and packed aseptically to give a long shelf life. Emulsifiers are not usually added to this product. More recently, with the advent of recombinating technology and with the preference of some consumers for vegetable oil-based products over those that contain milk fat, new products have appeared that require the addition of emulsifiers if a stable formulation is to be manufactured. If a recombinated coffee cream is produced, the formulation is more complex than for natural, concentrated coffee cream. Table 7.6 gives a typical formulation for recombinated coffee cream containing 19% milk fat, as suggested by Zadow (1982).

The recombinating process involves a two-stage homogenization with an 18 MPa first stage and a 3–4 MPa second stage. Presumably the emulsifiers are added to aid

Table 7.6 Typical formulation for a recombinated coffee cream

Ingredient	Composition (wt%)
Skim milk powder	3.0
Buttermilk powder	4.5
Anhydrous milk fat	19.0
Carrageenan	0.03
GMS	0.05
Tween 60	0.1
Water	73.32

From Zadow (1982), Reprinted by permission of the International Dairy Federation

in the homogenization process by reducing the energy required to form the fat/water interface. It may also be assumed that since in natural coffee creams the milk fat is already in a dispersed state, the energy required to reduce the particle size is less, and so emulsifiers are not needed. However, Zadow (1982) states that emulsifiers and stabilizers are required only if the product is to be given a high heat treatment (a UHT process or steam injection), which suggests a role for emulsifiers in product heat stability. Evidence exists to support this hypothesis and will be dealt with in more detail in Sect. 7.8.

Whereas coffee cream and recombined cream are used in a liquid form, coffee whiteners based on vegetable fat are also popular in dry powder form. Typical formulations for liquid and dry powder coffee whiteners are given in Table 7.7. Other water-soluble surfactants, such as Tween 60, are commonly used in place of the tartaric acid esters of monoglycerides listed in Table 7.7. Si (1991) states that the function of the emulsifiers in coffee whitener is to improve whitening ability and to aid powder dispersibility in coffee. Knightly (1969) has found that GMS is more effective in improving powder dispersibility, whereas Tween 60 is better at improving the rate of solution of the powder. Optimum whitening ability is attributed to small fat globules and a narrow particle-size range, and its attainment in coffee whitener has been attributed to the presence of GMS and its derivatives (Si, 1991). Whitening power in a dispersion is related to the surface area of the dispersed particles. The higher the surface area the greater the light reflectance from the dispersion and thus the greater the whitening effect. This is true for both dairy coffee creams and non-dairy coffee whiteners. Leo and Betscher (1971) have noted that there is an optimum particle size range for optimum optical density and whitening power of the dispersion. Over-homogenization of a coffee whitener formulation is known to result in a loss of whitening power.

The influence of emulsion droplet colloidal properties has been studied in detail by McClements and co-workers from both the theoretical and experimental perspective (Chanamai & McClements, 2001; Chantrapornchai et al., 1998, 1999a,b, 2001a,b; McClements, 2002a,b; McClements et al., 1998). There results have

Table 7.7 Typical formulations for liquid and powdered coffee whiteners

Ingredient	Composition (wt%)	
	liquid	powder
Fat	10.0	30.0
Sodium caseinate	1.0	4.0
Maltodextrin (DE28)	10.0	62.0
Monoglycerides	0.2	~1.5
Tartaric acid esters of monoglycerides	0.2	0.5
Carrageenan	0.05	–
Sodium alginate	–0.05	–
K ₂ HPO ₄	0.2	1.5
Flavour	300 ppm	1000 ppm
Water	To 100%	–

From Si (1991), Reprinted by permission of The Society of Dairy Technology

shown that the whiteness of an emulsion is strongly related to both droplet size and droplet concentration. Emulsion lightness increases up to a maximum as the droplet size increases, and then starts to decrease if the droplet size increases above a critical radius (Chantrapornchai et al., 1998). This confirms the finding of Leo and Betscher (1971) that there is an optimum particle size range for optimum whitening power of a coffee whitener.

The emulsifiers added to powdered formulations prior to spray drying are capable of stabilizing the emulsion in the liquid form. Sodium caseinate is usually required to give stable fat droplets in the dried powder (Sims, 1989), since an adsorbed proteinaceous layer is better able to withstand the extreme conditions in the drier. Because sodium caseinate is required at high concentration (typically in the range 3–15%), ways of reducing the amount in coffee whitener have been sought as a cost saving exercise. One way of doing this is to use sodium (or calcium) stearyl lactylate or sodium stearyl fumarate as an emulsifier. Miller and Werstak (1983) have used 2.5% monoglycerides plus sodium-2-stearyl lactylate (SSL) in the approximate ratio 7.3:1. They claim a reduction of sodium caseinate to 60% of that required in normal formulations. The function of SSL appears to be through its ability to form a complex with sodium caseinate (Leo & Betscher, 1971). It is likely that this interaction results in improved fat encapsulation in the dried state through increased interfacial rigidity of the adsorbed layer. This is analogous to the increased emulsion coalescence stability observed when GMS complexes with protein adsorbed at the oil/water-emulsion interface (Doxastakis & Sherman, 1984; Rivas & Sherman, 1984).

7.7 Cheese, Processed Cheese and Cheese Products

The addition of emulsifiers to traditional cheese has been reported only a few times in the literature (Drake et al., 1994, 1996). In large part this is due to the regulations in many countries that prohibit the use of additives in traditional products. However, food manufacturers are always looking to manufacture new products with novel textures, tastes and functionality, and this has led to the development of cheese-based and dairy analogue products that are not required to adhere to the strict legislation for natural cheese.

One of the first cheese products was processed cheese, the manufacture of which dates back approximately 100 years. Originally it was used as a way of increasing the shelf life of cheese and improving the palatability of lower quality cheese (Caric et al., 1985). To manufacture processed cheese, the cheese raw material (a mixture of rennet and fresh cheeses) is first cleaned, chopped, and heated at 70–82°C with emulsifying salts and other additives. In this instance, the term emulsifying salt is a little misleading, as they are not low molecular weight (nor proteinaceous) emulsifiers, nor do they play a direct role in creating a fat droplet dispersion. Their main effect in this instance is to increase the solubility of the aggregated cheese proteins through sequestration of calcium, thus improving the emulsifying ability of the

caseins. Heating and water addition are often combined by using direct steam injection. The pH of the mix is lowered to 5.6 to 5.8 using organic acids and the product is then extruded into packages (Rosentahl, 1991). Alternatively, the correct pH can be obtained by careful selection of a blend of polyphosphate emulsifying salts, which have some buffering capacity in this application (Lee et al., 1996 personal communication). The final product can have 15–25% fat and up to 58% water.

Processed cheese is a dispersion of fat droplets in a concentrated, gelled protein network. This is in contrast to cheese itself, where the fat is not found as discrete droplets, but forms a semi-continuous phase throughout the protein gel. Emulsion stability in the fat droplets is controlled, primarily, by adsorbed caseins or hydrolyzed casein fractions. Some manufacturers add mono- and diglycerides as emulsifiers. The structure and texture of processed cheese is closely linked with the size and distribution of fat globules in the cheese (Thomas et al., 1980; Shimp, 1982). If the fat in a processed cheese is weakly homogenized and large fat droplets are formed, the cheese is soft and melts easily. If the fat droplets are small, the cheese is hard and non-melting.

To control the structure of processed cheese, so-called emulsifying salts such as polyphosphates are added. Although these are not surface-active they play an important role in modifying the emulsifying activity of the surface-active caseins. Caseins bind calcium, and this has the effect of reducing their solubility, and thus their emulsifying ability. Emulsifying salts have a higher affinity for calcium than do the caseins, and thus they are able to improve the solubility and emulsifying properties of the caseins. Emulsifying salts are of two types: those that bind calcium relatively weakly and those that bind calcium more strongly. Weak emulsifying salts have a modest effect on the emulsifying properties of the caseins and lead to the formation of a soft cheese with relatively large fat droplets. Strong emulsifying salts give a greater improvement in the emulsifying capacity and result in a hard cheese with smaller fat droplets.

The use of low molecular weight, surface-active emulsifiers in processed cheese (Tweens and Spans) was first investigated in the 1950s (Holtorff et al., 1951). They are not as good as emulsifying salts at promoting structure formation in processed cheese, and in some cases they act to destabilize the fat emulsion by protein displacement from the surface.

Concern has been expressed over the non-nutritional effect of forming a phosphorous/calcium complex in processed cheese, as the calcium is less easily adsorbed in this form. The supplementation of emulsifying salts by monoglycerides has been investigated as a way of reducing the concentration of emulsifying salts. Gavriloova (1976) produced processed cheese of improved rheology and shelf life using an emulsifying salt/monoglyceride mixture. Zakharova et al. (1979a,b) achieved a 50% reduction in the concentration of emulsifying salts required by adding 1% monoglyceride to the cheese. The processed cheese produced was reported to be of good quality and to have improved hydrophilic (water binding) properties.

Lee et al. (1996) have studied the effect of adding small concentrations of low molecular weight surfactants as co-emulsifiers in combination with emulsifying salts in a model processed cheese. The surfactants used were sodium dodecyl sulphate

(SDS, an anionic surfactants), cetyl-trimethyl ammonium bromide (CTAB, a cationic surfactant), lecithin (a zwitterionic surfactant), and GMS (a non-ionic lipophilic surfactant). Although the addition of surfactant was observed to result in a reduction in fat-droplet size, the degree of uniformity of the dispersion differed between emulsifiers. In contrast to previous reports that smaller more evenly dispersed fat droplets gave firmer cheeses (Thomas et al., 1980; Shimp, 1982), Lee et al. (1996) found no relationship between processed cheese hardness and emulsion structure in the presence of emulsifiers. They concluded that electrostatic interactions between the emulsifier and the protein played the major role in determining the rheological properties of the cheese. The anionic surfactant SDS gave the softest cheese, the cationic surfactant CTAB the hardest. GMS and lecithin gave cheeses with rheological properties little different from the control with no added emulsifier.

Vial et al. (2006a) have designed a formulation for a light-textured foamed fresh acid cheese product that has improved spoonability, spreadability and a more homogeneous texture than conventional fresh acid cheeses. The final product contained 15% air by volume, which contributed to the altered properties of the product. The structure, texture and properties were found to be sensitive to the level of addition and type of emulsifier added (Vial et al., 2006b). Mono di-glycerides were found to reduce the ease of foaming in the formulation, whilst phospholipids in combination with whey protein concentrate gave softer textures. Low molecular weight emulsifiers had little impact on the stability of the product, with this being improved by the addition of WPC.

For traditional cheese products much of the research on emulsifier incorporation into the cheese structure has concentrated on improving the texture of reduced fat cheese (Drake et al., 1994, 1996). One of the nutritional criticisms of traditional cow's milk cheese is that it contains relatively large amounts of saturated fat. Thus, much effort has been put into either reducing the fat content of cheese or incorporating 'healthier' polyunsaturated fats into the cheese matrix. Early attempts at reduced fat cheese often led to products that had a poor texture, flavour and melting properties (Lobato-Calleros et al., 2001; Tunick et al., 1999). Swanson and co-workers (Drake et al., 1994, 1996; Drake et al., 1999) have found that emulsifiers can act in a similar way to fat-replacers by either improving water binding in the protein matrix, or by promoting the formation of mixed emulsifier-protein aggregates of a similar size to fat globules. These aggregates mimic the effect of fat in the cheese matrix and improve the texture properties of the cheese.

Other studies have looked at the effect of emulsifier blends on the properties of cheese containing canola oil as a functional food ingredient (Lobato-Calleros et al., 2003). One of the problems with fat replacement in cheese is that saturated fats are solid at storage (and eating) temperatures, whilst polyunsaturated fats are liquid. This has texture implications for the cheese, if it is desirable to mimic the texture of the saturated fat containing cheese. This has led to the investigation of the use of emulsifier blends to control the size of the polyunsaturated fat droplets in an attempt to modify the rheological properties of the product ingredient (Lobato-Calleros, et al., 2003). The rationale for this approach is the knowledge that low

molecular weight emulsifiers are known to alter the textural properties of protein gels and emulsion gels by changing the way in which the proteins interact with themselves and the way fat globules interact with the protein gel matrix.

Studies on, in particular, whey protein denaturation and gelation give some indication as to the mechanisms by which low-molecular emulsifiers affect the properties of protein gels. The situation is complex, with emulsifiers have differing effects depending on the emulsifier types and conditions of gelation. Lipids in whey protein concentrate (WPC) (derived from the original milk source) inhibit the gelation properties of the proteins by competing for hydrophobic binding sites in the protein (Mangino, 1992; Morr, 1992; Morr & Ha, 1993). In contrast, lecithin can enhance gelation or have no effect depending on the conditions (Ikeda & Foegeding, 1999a,b). The reason for this is the ability of whey proteins to form differing gel structures depending on the pH and salt concentration (Langton & Hermansson, 1992; Botcher & Foegeding, 1994; Bowland & Foegeding, 1995; Bowland et al., 1995). At low ionic strength, low pH well away from the iso-electric point aggregation occurs in a linear fashion to form a fine-stranded gel (Langton & Hermansson, 1992). At high ionic strength and/or pH close to the isoelectric point a particulate type gels are formed, and under intermediate conditions, between the two cases above, mixed gel structures form (Botcher & Foegeding, 1994; Bowland & Foegeding, 1995; Bowland et al., 1995). Foegeding and co-workers (Ikeda & Foegeding, 1999a,b) have shown that lecithin increases the gelation rate and gel strength for fine-stranded and mixed gels, but has no effect on particle gels. They hypothesise (Ikeda & Foegeding 1999a,b) that protein aggregation is facilitated by lecithin-protein interactions at low NaCl concentrations, because lecithin is iso-electric over a wide pH range. Consequently, there will be no electrostatic repulsion with the protein. As NaCl concentration is increased, charge screening will reduce the electrostatic repulsive barrier to protein aggregation, and the effect that lecithin has on promoting protein-protein interaction is reduced.

Emulsifiers can have a further effect on the mechanical properties of protein gels when fat droplets are present dispersed throughout the gel network. These so-called emulsion gels are formed when an oil-in-water emulsion is converted to a gel through the action of heat. A gel can be formed at lower protein concentrations than for a solution of the protein, since the fat droplets act as filler particles and increase the effective concentration of the proteins. The effect of lecithin on the mechanical properties of whey protein emulsion gels has been studied by Dickinson et al. (Dickinson & Yamamoto, 1996a,b; Dickinson et al., 1996). When lecithin is added before homogenisation (Dickinson et al., 1996) protein is displaced from the emulsion droplet surface. The droplets are not able to interact with the protein gel network through protein-protein interactions between the adsorbed and bulk phase protein, and they behave as inert filler particles that weaken the gel structure (Jost et al., 1989). Adding lecithin after homogenization does not cause protein displacement. Under these conditions an increase in the mechanical strength of the gel is seen (Dickinson & Yamamoto, 1996a,b), because the adsorbed proteins interact with the gel network, and strengthen it. Dickinson and Yamamoto (1996a) propose that lecithin is able to interact with adsorbed and non-adsorbed protein, thereby enhancing protein-protein cross-links and strengthening the gel.

Emulsifiers other than lecithin also have an effect on whey protein gel strength. The addition of glycerol monooleate (GMO) to WPC emulsion gels leads to a decreased elastic modulus at low additions of GMO, but this is recovered for higher levels of addition (Chen & Dickinson, 1999). Again it is believed that the decreased modulus results from protein displacement from the fat droplet surface, which does not allow them to participate in the gel network. At higher levels of GMO addition, the emulsifier aids the formation of a finer initial emulsion (smaller droplets), and when the emulsion gel is formed, even though the droplet do not crosslink with the gel structure, because they are smaller they perturb the protein gel network less (Chen & Dickinson, 1999).

The non-ionic emulsifier Tween-20 (T20) has a complex effect on emulsion gel strength (Dickinson & Hong, 1995; Dickinson et al., 1996), which is most likely due to its ability to bind with the major whey protein β -lactoglobulin to form a 1:1 complex. If the protein and T20 are present at a molar ratio (R) of protein:T20 of 1:1 (R = 1) there is a big increase in the gel elastic modulus for the heat set emulsion gel compared to gels made at lower R. As R is increased to 2, the modulus decreases sharply, and if R is increased above 4 the modulus increases again. The increase in modulus at R = 1 is attributed to the 1:1 complex formed between β -lac and T20 (Dickinson et al., 1996). As R is increased there is a displacement of protein is displaced from the emulsion droplet surface which amounts to about 90% displacement at R \approx 2. This reduces extent of interaction of the emulsion droplets with the aggregated protein network and reduces the elastic modulus. When R exceeds 4 it is thought that mixed micelles of protein and T20 form, and these are able to reinforce the gel (Dickinson et al., 1996).

7.8 Recombined, Concentrated, and Evaporated Milks and Dairy Protein-Based Emulsions

Recombined and concentrated milk products are produced for economic reasons. The cost-effectiveness of transporting milk products that have been concentrated by removal of a proportion of the water phase, and the associated increases in shelf life, make milk concentration a viable process. Similarly, it is cost-effective to transport dehydrated ingredients for recombination into milk. The function of emulsifiers is, primarily, to aid in the formation and stabilization of the emulsions. A secondary function, which is claimed by many manufacturers of emulsifiers, is the effect that emulsifiers have on the heat stability of milks and milk products. This is of particular importance in enteral and parenteral emulsion products. These products are either tube-fed to seriously ill hospital patients (enteral formulations) or to new-born or young babies (parenteral formulations). In both cases microbial sterility of the product is very important, as it is undesirable to expose either of these two populations to high levels of bacteria since their immune systems may be suppressed or under-developed. As a consequence these types of emulsion are subjected to very intense heat treatments, and this can cause problems with emulsion fat droplet stability.

The effect of emulsifiers on milk and protein emulsion heat stability may be due to two effects. Low molecular weight emulsifiers are well known to compete for interfacial area with proteins and to displace them from the fat droplet surface (Dickinson & McClements, 1995). Displacement of protein depends on a number of factors such as the type (oil soluble or water soluble) and concentration of emulsifier (Dickinson et al., 1993a; Euston et al., 1995a) and environmental conditions such as the temperature (Dickinson & Tanai, 1992). The second effect of emulsifiers is that they are capable of binding to proteins and affect their heat stability and their adsorption at surfaces (Bos et al., 1997). The milk whey protein β -lactoglobulin is particularly susceptible to emulsifier-induced changes in heat stability since it has a hydrophobic cleft capable of binding amphiphilic and hydrophobic ligands (Hambling et al., 1992). Puyol et al. (1998) have reported that palmitic acid binding to β -lactoglobulin increases the temperature at which the protein denatures and gels, and Creamer (1995) has shown that binding of SDS or palmitic acid to β -lactoglobulin stabilizes it against denaturation in urea solutions.

In addition to reviewing the effect of emulsifiers on the properties of traditional milk emulsions, we will also summarize the relevant results on the heat stability of simple oil-in-water emulsions stabilized by dairy proteins. These studies have a direct relevance to the heat stability of commercial milks.

7.8.1 Recombined Milk

Recombination of dairy ingredients into milk products is a popular and viable alternative to the export/import of fresh dairy products. It is particularly important in countries where, for various reasons (e.g. transport delays, high temperatures), the shelf life of fresh products prohibits their importation or local production. In such cases, dried dairy ingredients are recombined close to the point of sale, so as to reduce these problems.

Two approaches to recombining of whole milk can be used;

1. Recombination of anhydrous milk fat (AMF), skim milk powder (SMP) and water.
2. Reconstitution of whole milk powder (WMP) with water.

In the past the latter process was, generally, less popular because of problems with the oxidative stability of the fat in the powder during storage. Advances in gas packing of powders, more regular shipping, and use of cooler storage facilities have removed this obstacle. Zadow (1982) noted that the choice of whether to recombine or reconstitute WMP depends on the export strategy of a particular manufacturer. The manufacture of different dairy products is often linked for practical reasons. If a particular manufacturer is making large quantities of butter, this requires separation of the cream (fat droplet) phase from the whole milk. This leaves a skimmed milk stream that is often dried to powdered SMP. Similarly, if cheese is the major product (which is made from whole milk), WMP is usually the major dried form of

milk manufactured by the processor. Thus, it makes economic sense for a butter-led industry to have a recombining strategy, whilst a cheese-led industry will have a reconstitution strategy. During the 1970s, an increase in the production of reconstituted WMP was seen. This corresponded to a change from a butter/SMP-oriented export industry to a cheese/WMP-oriented export strategy in countries such as New Zealand and Australia (Zadow, 1982).

In the recombination process, AMF, SMP and water are recombined to give a product with the same fat and protein content as whole milk (Kieseker, 1983). The skim milk powder is dissolved in the water at 40 to 55°C. The fat is added in a molten state, and the mixture is homogenized 14.0 to 17.5 MPa for the first stage and at 3.5 MPa at 55 to 60°C in the second stage. The milk is then subjected to one of three heat treatments: pasteurization at 72.2°C for 15 seconds; UHT processing at 135 to 150°C for 2 to 5 seconds; or in-can sterilization (e.g. 120°C for 20 min). UHT processing can be by either direct steam injection or indirect heating in a plate or tubular heat exchanger.

Many manufacturers add low molecular weight emulsifiers to the formulation, particularly mono- and diglycerides (Zadow, 1982; Kieseker, 1983; Sjollema, 1987). Emulsifiers in the form of phospholipids can also be added through the practice of replacing up to 20% of the SMP with buttermilk powder (BMP) (Zadow, 1982; Kieseker, 1983; Sjollema, 1987) to give an improved taste.

It is claimed that emulsifiers aid in the formation of the milk fat emulsion during homogenization. Recent research by Mayhill and Newstead (1992), however, suggests that little benefit in terms of emulsion formation and stability is gained by their addition. In the case of mono-/diglyceride emulsifiers, it appears that tradition dictates their presence in the formulation. It is possible that any reduction in creaming due to reduced fat-droplet size in the presence of emulsifier is cancelled out by reduced emulsion stability caused by protein displacement.

7.8.2 Evaporated and Concentrated Milks

Evaporated and concentrated milks are made by removal of water from natural or recombined milks. The technology used to make these products includes evaporation under reduced pressure, reverse osmosis, ultrafiltration, and freeze concentration (Knipschildt & Andersen, 1994; Varnan & Sutherland, 1994). These concentrated milk products are more susceptible to heat coagulation when UHT processed or sterilized, than are normal concentration milks.

It has been known for some time that the heat stability of skim milk can be altered by surfactant molecules (Singh & Creamer, 1992). Anionic surfactants such as SDS have been shown to shift the maximum in the heat stability/pH profile of skim milk to more acidic values and to give a marked increase in maximum heat stability (Fox & Hearn, 1978). Cationic surfactants such as CTAB move the maximum heat stability to more alkaline values and give only a slight improvement in the heat stability at the maximum (Pearce, 1978; Shalabi & Fox, 1982). The mechanism

by which these changes occur is not known for certain. It has been suggested that binding of the surfactant to casein micelles alters the surface charge, which leads to changes in heat stability (Fox & Hearn, 1978; Pearce, 1978; Shalabi & Fox, 1982). This view is supported by the fact that non-ionic surfactants such as Triton X and Tween 80 have no effect on the heat stability of skim milk (Fox & Hearn, 1978). Research into the effect of addition of SDS and CTAB on the heat stability of milk proteins is useful only in helping to understand the process of heat coagulation. These surfactants cannot be added to milk products. In addition to this, in most concentrated milk products and in whole milk, the fat globules play a role in heat stability. Surfactants would interact with both the fat-droplet surface and the milk proteins. This makes the process of heat coagulation in fat-containing milks more complicated than in skim milk.

The milk fat globule membrane is known to play a role in the heat stability of milk. In non-homogenized whole milk the fat globules have little effect on heat stability (Singh & Creamer, 1992). However, after homogenization the heat coagulation time decreases with increasing homogenization pressure (Singh & Creamer, 1992). Obviously, this is an important observation since homogenization of milk is often essential so as to give adequate creaming stability.

It has been known for some time that lecithin can be used to increase the heat stability of homogenized and concentrated milks (Maxcy & Sommer, 1954; Leviton & Pallansch, 1962; Hardy et al., 1985; Singh & Tokley, 1990; Singh et al., 1992). The mechanism of lecithin action has as yet not been elucidated. Lecithin is known to displace protein from the fat-droplet surface (Courthaudon et al., 1991; Dickinson et al., 1993a; Dickinson & Iveson, 1993) and to complex with milk proteins (Barratt & Rayner, 1972; Korver & Meder, 1974; Hanssens & van Cauwelaert, 1978). Hardy et al. (1985) and McRae and Muir (1992) also believe that lecithin/protein interactions play a role in heat stability of concentrated milks. Singh et al. (1992) have put forward the view that lecithin may promote the formation of a complex between κ -casein in the micelles and β -lactoglobulin. The formation of the same complex can be promoted by pre-heating concentrated milks prior to the main heat treatment. This has been shown by Newstead et al. (1977) to have a stabilizing effect on the heat stability of recombined evaporated milk. It is interesting to note that, despite evidence of lecithin/protein interactions, Singh et al. (1992) have shown that the heat stability of skim milk is unaffected by lecithin addition. This is powerful evidence for the main stabilizing effect being fat-droplet based.

7.8.3 Dairy Protein-Based Emulsions

Dairy emulsions are formed by homogenizing fat or oil in the presence of an emulsifying agent, usually a protein. In dairy systems the common protein emulsifiers are the milk caseins and the whey proteins. Of these the caseins are very heat stable (Crujjsen et al., 1994) and casein stabilized emulsions must be heated at high temperature for long times before they become unstable. The whey proteins, on the

other hand are globular proteins, and as such they will denature and aggregate on heating. The fact that milk whey protein denaturation only occurs above the temperature range 70–80°C only exacerbates the problem since common processing temperatures are in this range or above. The obvious response to this would be to remove whey proteins from milk protein based emulsions and to use only the caseins. However, whey proteins are added for their nutritional value, especially in infant formulations based on cow's milk which are designed to have a composition that mimics human breast milk, and also because they are stable at acid pH whereas caseins are not. In paediatric formulae, milk protein based formulations are made with an increased level of whey protein compared to normal milk (Emmett & Rogers, 1997). The reason for this is that human milk has a higher whey protein: casein ratio (60:40) than cows milk (Emmett & Rogers, 1997). The sterility of these infant formulae is of critical importance since they are fed to premature or newborn infants who may not have an immune system that is resistant to common bacterial contaminants. As a consequence these are usually given an intense heat-treatment, such as in-container sterilization (e.g. 120°C for 20 min) which can lead to instability of the emulsion. To avoid this, the milk proteins in these formulations are usually hydrolyzed, i.e. they have undergone enzymatic hydrolysis to break up their native structure and release peptides and amino acids. Hydrolysis can be beneficial for two reasons. The whey protein β -lactoglobulin has been linked with allergy to cow's milk (Cordle, 1994; Tormo et al., 1998), and its hydrolysis can remove this by produces small peptide fragments and/or free amino acids, that are more easily digested and absorbed in the gut (Frøkjær, 1994). Secondly, hydrolysis of whey proteins can reduce its susceptibility to heat denaturation. Unfortunately, this does not necessarily mean that dairy emulsions made with whey hydrolyzed proteins are more heat stable. Hydrolyzed protein form emulsions that are less stable to coalescence, and this is accelerated by heating (Euston & Finnigan, 2001). As a consequence, research has focused on how other ingredients affect the heat stability of food emulsions (Euston et al., 2001; Euston et al., 2002). In particular, low molecular weight emulsifiers have been shown to either increase or a decrease the aggregation rate in heated whey protein emulsions depending on the surfactant type (oil or water-soluble) and the concentration (Euston et al., 2001). This was explained in terms of either the ability of surfactants to displace protein from the droplet surface, or their ability to bind to whey proteins (particularly β -lactoglobulin, β -lac) and thus to influence denaturation and aggregation (Euston et al., 2001).

7.9 Other Dairy Applications of Emulsifiers

Emulsifiers have been added to other dairy products to exploit functional properties not normally associated with such emulsifiers. In recombined butter, phospholipids are added as anti-spitting agents, to prevent fat spitting during heating, and monoglycerides have been claimed to provide better 'stand-up' properties during storage (Kieseker, 1983).

Both sucrose esters and glycerol esters of fatty acids (monoglycerides) are finding a wide range of novel uses. In addition to being good emulsifiers for use in ice cream (Buck et al., 1986), they are known to improve the mouthfeel in yoghurt (Farooq & Haque, 1992), inhibit microbial growth (Conley & Kabara, 1973; Kato & Shibasaki, 1975; Shibasaki, 1979; Beuchat, 1980; Kabara, 1983; Tsuchido et al., 1981; 1987), enhance the thermal death rate of bacteria and bacterial spores (Tsuchido et al., 1983), and increase the heat stability of bovine serum albumin (Makino & Moriyama, 1991). It appears that these functions are a result of their ability to bind to proteins (Clark et al., 1992; Fontecha & Swaisgood, 1994).

7.10 Summary

Emulsifiers are very versatile food additives that can be used as aids to emulsion formation (e.g. in coffee whiteners/creamers and recombined products), or in contrast, as emulsion destabilizers in ice cream, whipping cream and whipped toppings. These two functions rely on the classical ability of emulsifiers to act as surface-active agents. In this way they can influence the formation and stabilization of the fat-droplet adsorbed layer and the composition of this layer. This ability of emulsifiers to displace protein from the droplet surface also, probably, accounts for the increase in heat stability of concentrated milks when phospholipids are added.

In a similar vein, displacement of adsorbed caseinate by GMS in cream liqueurs can be used to give increased acid stability to these products. A secondary function of the GMS in cream liqueurs is its ability to interact with proteins, thereby forming a weak gel in the aqueous phase. The associated increase in viscosity gives increased creaming stability. The ability of the emulsifier SSL to interact with caseinate is also exploited in coffee whiteners. The replacement of sodium caseinate in coffee whitener is achieved using SSL. It has been hypothesized (Leo & Betscher, 1971) that this is possible because of the increased mechanical strength of a protein/SSL adsorbed layer caused by emulsifier/protein interactions.

In processed cheese and cheese substitutes, the ability of charged emulsifiers to interact with proteins in the cheese matrix may prove a useful way of controlling cheese texture. This would introduce a way of reducing emulsifying salts such as mono- and polyphosphates. The final, but very important, function of some emulsifiers is their ability to act as initiators of fat crystallization. This is a particularly important function in whipped products, and in combination with protein displacement forms the basis of the formation of the whipped foam structure.

A wide range of emulsifiers allowed for food use can be added to achieve the above effects. Of late, consumer opinion has been focused on the 'unnatural' nature of synthetic emulsifiers. There is a slow push toward the replacement of synthetic emulsifiers with natural emulsifiers such as milk and soy phospholipid, and milk fat-derived mono- and diglycerides. The future may see a large increase in products such as BMP, which is rich in natural milk phospholipid as well as protein, and milk fat that has been enriched in mono- and diglycerides by processes such as controlled glycerolysis of triglycerides.

Acknowledgements The author would like to thank the following people: Dr. David Newstead (Fonterra Research Centre, New Zealand) for discussions on heat stability of concentrated milks; Dr Siew-Kim Lee (Fonterra Research Centre, New Zealand) for information on use of emulsifiers in processed cheese; Professor Douglas Goff (Dept. of Food Science, University of Guelph, Canada) for giving his permission for the use of the micrographs in Figs. 7.1 and 7.4.

References

- Abrahamson, K., Frennborn, P., Dejmek, P. & Buchheim, W. (1988). Effects of homogenization and heating conditions on physico-chemical properties of coffee cream, *Milchwissenschaft*, 43, 762–765.
- Anderson, M. & Brooker, B.E. (1988). Dairy foams, in *Advances in Food Emulsions and Foams* (eds. E. Dickinson & G. Stainsby), Elsevier, London, pp. 221–253.
- Anderson, M., Brooker, B.E., Cawston, T.C. & Cheeseman, G.C. (1977). Changes during storage in stability and composition of ultra-heat-treated aseptically-packed cream of 18% fat content, *Journal of Dairy Research*, 44, 111–123.
- Arbuckle, W.S. (1986). *Ice Cream*, 4th ed., AVI, Westport, CT.
- Banks, W. & Muir, D.D. (1988). Stability of alcohol containing emulsions, in *Advances in Food Emulsions and Foams* (eds. E. Dickinson & G. Stainsby), Elsevier, London, pp. 257–283.
- Banks, W. & Wilson, A.G. (1981). The formulation of cream-based liqueurs, *Milk Industry*, 83, 16–18.
- Barfod, N.M. & Krog, N. (1987). Destabilization and fat crystallization of whippable emulsions (toppings) studied by pulsed NMR, *Journal of the American Oil Chemists Society*, 64, 112–119.
- Barfod, N.M., Krog, N., Larsen, G. & Buchheim, W. (1991). Effects of emulsifiers on protein-fat mixtures in ice-cream mix during ageing I: Quantitative analyses, *Fat Science and Technology*, 93, 24–29.
- Barratt, M.D. & Rayner, L. (1972). Lysolecithin-casein interactions. I. Nuclear magnetic resonance and spin label studies, *Biochimica et Biophysica Acta*, 255, 974–980.
- Bergensstahl, B. et al. (1992). Adsorption structures in emulsions, in *Emulsions – A Fundamental and Practical Approach* (ed. J. Sjoblom), NATO ASI Series C, 363, 51–60.
- Berger, K.G. (1990). Ice cream, in *Food Emulsions* (eds. K. Larsson & S. Friberg), Marcel Dekker, New York, pp. 367–444.
- Beuchat, L.R. (1980). Comparison of anti-Vibrio activities of potassium sorbate, sodium benzoate and glycerol and sucrose esters of fatty acids, *Applied and Environmental Microbiology*, 39, 1178–1182.
- Boode, K. (1992). Partial Coalescence in Oil-in-Water Emulsions, *PhD Thesis*, Wageningen Agricultural University, The Netherlands.
- Boode, K. & Walstra, P. (1993). Kinetics of partial coalescence in oil-in-water emulsions, in *Food Colloids and Polymers: Stability and Mechanical Properties* (eds. E. Dickinson & P. Walstra), Royal Society of Chemistry, London, pp. 23–30.
- Bos M., Nylander, T., Arnebrant, T. & Clark, D.C., (1997). Protein/emulsifier interactions, in *Food Emulsifiers and Their Applications* (eds. G.L. Hasenheuttl & R.W. Hartel), Chapman Hall, New York, pp. 95–146.
- Botcher, S.R. & Foegeding, E.A. (1994). Whey protein gels: Fracture stress and strain and related microstructural properties, *Food Hydrocolloids*, 8, 113–123.
- Bowland, E.L. & Foegeding, E.A. (1995). Effects of anions on thermally induced whey protein isolate gels, *Food Hydrocolloids*, 9, 47–56.
- Bowland, E.L., Foegeding, E.A. & Hamman, D. (1995). Rheological analysis of anion-induced matrix transformations in thermally induced whey protein isolate gels, *Food Hydrocolloids*, 9, 57–64.

- Buchheim, W. (1986). Membranes of milk fat globules—ultrastructural, biochemical and technological aspects, *Kieler Milchwirtschaftliche Forschungsberichte*, 38, 227–246.
- Buchheim, W., Barford, N.M. & Krog, N. (1985). Relation between microstructure, destabilization phenomena and rheological properties of whippable emulsions, *Food Microstructure*, 4, 221–232.
- Buck, J.S., Walker, C.E. & Pierce, M.M. (1986). Evaluation of sucrose esters in ice cream, *Journal of Food Science*, 51, 489–493.
- Bullin, S., Dickinson, E., Impey, S.J., Narhan, S.K. & Stainsby, G. (1988). Stability aspects of casein-containing emulsions: Effect of added alcohol or dextran, in *Gums & Stabilizers for the Food Industry* (eds. G.O. Phillips et al.), IRL Press, Oxford, Vol. 4, pp. 337–345.
- Burgaud, I. & Dickinson, E. (1990). Emulsifying effects of food macromolecules in presence of ethanol, *Journal of Food Science*, 55, 875–876.
- Caric, M., Gantar, M. & Kalab, M. (1985). Effects of emulsifying agents on the microstructure and other characteristics of process cheeses—a review, *Food Microstructure*, 4, 297–312.
- Chanamai, R. & McClements, D.J. (2001). Prediction of emulsion colour from droplet characteristics: Monodisperse oil-in-water emulsions, *Food Hydrocolloids*, 15, 83–92.
- Chantrapornchai, W., Clydesdale, F. & McClements D.J. (1998). Influence of droplet size and concentration on the color of oil-in-water emulsions, *Journal of Agriculture and Food Chemistry*, 46, 2914–2920.
- Chantrapornchai, W., Clydesdale, F. & McClements D.J. (1999a). Theoretical and experimental study of spectra reflectance and colour of concentrated oil-in-water emulsions, *Journal of Colloid and Interface Science*, 218, 324–330.
- Chantrapornchai, W., Clydesdale, F. & McClements D.J. (1999b). Influence of droplet characteristics on the optical properties of coloured oil-in-water emulsions, *Colloids and Surfaces A*, 155, 373–382.
- Chantrapornchai, W., Clydesdale, F. & McClements D.J. (2001a). Influence of flocculation on optical properties of emulsions, *Journal of Food Science*, 66, 464–469.
- Chantrapornchai, W., Clydesdale, F. & McClements D.J. (2001b). Influence of relative reflective index on optical properties of emulsions, *Food Research International*, 34, 827–835.
- Chen, J.S., Dickinson, E., & Iveson, G. (1993). Interfacial interactions, competitive adsorption and emulsion stability, *Food Structure*, 12, 135–146.
- Chen, J. & Dickinson, E. (1999). Effect of monoglycerides and diglycerol-esters on viscoelasticity of heat-set whey protein emulsion gels, *International Journal of Food Science and Technology*, 34, 493–501.
- Clark, D.C., Wilde, P.J., Wilson, D.R. & Wustneck, R. (1992). The interaction of sucrose esters with β -lactoglobulin and β -casein from bovine milk, *Food Hydrocolloids*, 6, 173–186.
- Clarke C. (2005). *The Science of Ice Cream*. Royal Society of Chemistry, Cambridge, UK.
- Conley, A.J. & Kabara, J.J. (1973). Antimicrobial action of esters of polyhydric alcohols, *Antimicrobial Agents Chemotherapy*, 4, 501–506.
- Cordle, C.T. (1994). Control of food allergies using protein hydrolysates. *Food Technology*, 48(10), 72–76.
- Courthaudon, J.-L., Dickinson, E. & Christie, W.W. (1991). Competitive adsorption of lecithin and β -casein in oil-in-water emulsions, *Journal of Agriculture and Food Chemistry*, 39, 1365–1368.
- Creamer, L.K. (1995). Effect of sodium dodecyl sulphate and palmitic acid on the equilibrium unfolding of bovine β -lactoglobulin, *Biochemistry*, 34, 7170–7176.
- Crujisen, J.M.M., Van Boekel, M.A.J.S. & Walstra, P. (1994). Effect of malto-dextrins on the heat-stability of caseinate emulsions, *Netherlands Milk and Dairy Journal*, 48, 177–180.
- Darling, D.F. (1982). Recent advances in the destabilization of dairy emulsions, *Journal of Dairy Research*, 45, 197–208.
- Darling, D.F. & Butcher, D.W. (1978). Milk fat globule in homogenized cream, *Journal of Dairy Research*, 45, 197–208.
- Darling, D.F. & Birkett, R.J. (1987). Food colloids in practice, in *Food Emulsions and Foams* (ed. E. Dickinson), Royal Society of Chemistry, London, pp. 1–29.
- Davies, E., Dickinson, E. & Bee, R.D. (2000). Shear stability of sodium caseinate emulsions containing monoglyceride and triglyceride crystals, *Food Hydrocolloids*, 14, 145–153.

- Davies, E., Dickinson, E. & Bee, R.D. (2001). Orthokinetic destabilization of emulsions by saturated and unsaturated monoglycerides, *International Dairy Journal*, 11, 827–836.
- Dickinson, E. (1986). Mixed proteinaceous emulsifiers: Review of competitive protein adsorption and the relationship to food colloid stabilization, *Food Hydrocolloids*, 1, 3–23.
- Dickinson, E. (1992). Structure and composition of adsorbed protein layers and the relationship to emulsion stability, *Journal of the Chemical Society Faraday Transactions*, 889, 2973–2983.
- Dickinson, E. (1993). Protein-polysaccharide interactions in food colloids, in *Food Colloids and Polymers: Stability and Mechanical Properties* (eds. E. Dickinson and P. Walstra), Royal Society of Chemistry, London, pp. 77–93.
- Dickinson, E. & Euston, S.R. (1990). Stability of food emulsions containing both protein and polysaccharide, in *Food Polymers, Gels and Colloids* (ed. E. Dickinson), Royal Society of Chemistry, London, pp. 132–146.
- Dickinson, E. & Hong, S.T. Influence of water-soluble nonionic emulsifier on the rheology of heat-set protein-stabilized emulsion gels. *Journal of Agriculture and Food Chemistry*, 43, 2560–2566.
- Dickinson, E. & Iveson, G. (1993). Adsorbed films of β -lactoglobulin + lecithin at the hydrocarbon-water and the triglyceride-water interfaces, *Food Hydrocolloids*, 6, 533–541.
- Dickinson, E. & McClements, D.J. (1995). *Advances in Food Colloids*. Blackie Academic & Professional, Glasgow, pp. 18–23.
- Dickinson, E. & Stainsby, G. (1982). *Colloids in Food*. Applied Science Publishers, London.
- Dickinson, E. & Stainsby, G. (1988). Emulsion stability, in *Advances in Food Emulsions and Foams* (eds. E. Dickinson and G. Stainsby), Elsevier, London, pp. 1–44.
- Dickinson, E. & Tanai, S. (1992). Temperature dependence of the displacement of proteins from the emulsion droplet surface by surfactants, *Food Hydrocolloids*, 6, 163–171.
- Dickinson, E. & Williams, A. (1994). Orthokinetic coalescence of protein stabilized emulsions, *Colloids and Surfaces A*, 88, 317–326.
- Dickinson, E. & Woskett, C.M. (1988a). Competitive adsorption between proteins and small molecules in food emulsions, in *Food Colloids* (eds. R.D. Bee et al.), Royal Society of Chemistry, London, pp. 74–96.
- Dickinson, E. & Woskett, C.M. (1988b). Effect of alcohol on the adsorption of casein at the oil/water interface, *Food Hydrocolloids*, 2, 187–195.
- Dickinson, E. & Yamamoto, Y. (1996a). Effect of lecithin on the viscoelastic properties of β -lactoglobulin-stabilized emulsion gels, *Food Hydrocolloids*, 10, 301–307.
- Dickinson, E. & Yamamoto, Y. (1996b). Viscoelastic properties of heat-set whey protein-stabilized emulsion gels with added lecithin, *Journal of Food Science*, 61, 811–816.
- Dickinson, E., Murray, B.S. & Stainsby, G. (1988a). Coalescence kinetics of protein-stabilized emulsion droplets, in *Gums and Stabilizers for the Food Industry* (eds. G.O. Phillips et al.), Vol. 4, IRL Press, Oxford, pp. 463–472.
- Dickinson, E., Rolfe, S.E. & Dalgleish, D.G. (1988b). Competitive adsorption of α_{s1} -casein and β -casein in oil-in-water emulsions, *Food Hydrocolloids*, 2, 397–405.
- Dickinson, E., Mauffret, A., Rolfe, S.E. & Woskett, C.M. (1989a). Adsorption at interfaces in dairy systems, *Dairy Technology*, 42, 18–22.
- Dickinson, E., Narhan, S.K. & Stainsby, G. (1989b). Stability of cream liqueurs containing low-molecular-weight surfactants, *Journal of Food Science*, 54, 77–81.
- Dickinson, E., Rolfe, S.E. & Dalgleish, D.G. (1989c). Competitive adsorption in oil-in-water emulsions containing α -lactalbumin and β -lactoglobulin, *Food Hydrocolloids*, 3, 193–203.
- Dickinson, E., Euston S.R. & Woskett, C.M. (1990a). Competitive adsorption of food macromolecules and surfactants at the oil/water interface, *Progress in Colloid and Polymer Science*, 82, 65–75.
- Dickinson, E., Rolfe, S.E. & Dalgleish, D.G. (1990b). Surface shear viscometry as a probe of protein-protein interactions in mixed protein films adsorbed at the oil/water interface, *International Journal of Biological Macromolecules*, 12, 189–194.
- Dickinson, E., Iveson, G. & Tanai, S. (1993a). Competitive adsorption in protein stabilized emulsions containing oil-soluble and water-soluble surfactants, in *Food Colloids and Polymers:*

- Stability and Mechanical Properties* (eds. E. Dickinson and P. Walstra), Royal Society of Chemistry, London, pp. 312–322.
- Dickinson, E., Owusu, R.K. & Williams, A. (1993b). Orthokinetic destabilization of a protein-stabilized emulsion by a water-soluble surfactant, *Journal of the Chemical Society, Faraday Transactions*, 89, 856–866.
- Dickinson, E., Hong, S.-T. & Yamamoto, Y. (1996). Rheology of heat-set emulsions gels containing β -lactoglobulin and small-molecule surfactants, *Netherlands Milk and Dairy Journal*, 50, 199–207.
- Doxastakis, G. & Sherman, P. (1984). The interaction of sodium caseinate with monoglyceride and diglyceride at the oil/water interface in corn oil-in-water emulsions and its effect on emulsion stability, *Colloid and Polymer Science*, 262, 902–905.
- Drake, M.A., Boute, T.T., Luedecke, L.O. & Swanson, B.G. (1994). Milkfat sucrose polyesters as fat substitutes in Cheddar-type cheese, *Journal of Food Science*, 59, 326–327, 365.
- Drake, M.A., Herrett, W., Boylston, T.D. & Swanson, B.G. (1996). Lecithin improves texture of reduced fat cheeses, *Journal of Food Science*, 61, 639–642.
- Drake, M.A., Truong, V.D. Daubert, C.R. (1999). Rheological and sensory properties of reduced-fat processed cheeses containing lecithin. *Journal of Food Science*, 64, 744–747.
- Emmett, P.M. & Rogers, I.S. (1997). Properties of human milk and their relationship with maternal nutrition, *Early Human Development*, 49, S7–S28.
- Euston, S.E. (1989). Competitive Adsorption of Milk Proteins in Oil/Water Emulsions, *PhD Thesis*, University of Leeds, United Kingdom.
- Euston S.E., Singh H., Munro P.A. & Dalgleish D.G. (1995a). Competitive adsorption between sodium caseinate and oil-soluble and water-soluble surfactants in oil-in-water emulsions, *Journal of Food Science*, 60, 1124–1131.
- Euston, S.E., Singh H., Munro P.A. & Dalgleish D.G. (1995b). The influence of glycerol monostearate in oil-in-water emulsions stabilized by milk protein, *Journal of Food Science*, 61, 916–920.
- Euston, S.R. & Finnigan, S.R. (2001). Aggregation kinetics in heated emulsions stabilized by hydrolysed whey protein, *Journal of Agriculture and Food Chemistry*, 49(11), 5576–5583.
- Euston, S.R., Finnigan, S.R. & Hirst, R.L. (2001). Aggregation kinetics in heated whey protein stabilized emulsions II. Effect of low-molecular weight emulsifiers, *Food Hydrocolloids*, 15(3), 253–262.
- Euston, S.R., Finnigan, S.R. & Hirst, R.L. (2002). Aggregation kinetics in heated whey protein stabilized emulsions III. Effect of polysaccharide stabilizers, *Food Hydrocolloids*, 16, 499–505.
- Farooq, K. & Haque, Z.U. (1992). Effect of sugar esters on the textural properties of non-fat low calorie yoghurt, *Journal of Dairy Science*, 75, 2676, 2680.
- Fontecha, J. & Swaisgood, H.E. (1994). Interaction of sucrose esters with skim milk proteins as characterized by affinity chromatography, *Journal of Dairy Science*, 77, 3545–3551.
- Fox, P.F. & Hearn, C.M. (1978). Heat stability of milk: Influence of denaturable proteins and detergents on pH sensitivity, *Journal of Dairy Research*, 45, 159–172.
- Frøkjær, S. (1994). Use of hydrolysates for protein supplementation, *Food Technology*, 48(10), 86–88.
- Gavrilova, N.B. (1976). Improvement of structural and mechanical properties of sliced process cheese, *Zernoperabatyvayuschchaya I Pishchevaya Promyshlennost*, 6, 131–136 (In Russian).
- Goff, H.D. (1988). Emulsifiers in ice cream: How do they work? *Modern Dairy*, 6, 15–18.
- Goff, H.D., Verespej, E. & Smith, A.K. (1999). A study of fat and air structures in ice cream, *International Dairy Journal*, 9, 817–829.
- Govin, R. & Leeder, J.G. (1971). Action of emulsifiers in ice cream utilizing the HLB concept, *Journal of Food Science*, 36, 718–722.
- Hambling, S.G., McAlpine, A.S. & Sawyer, L. (1992). β -lactoglobulin, in *Advanced Dairy Chemistry -1: Proteins* (ed. P.F. Fox), Elsevier, London, pp. 141–190.
- Hanssens, I. & van Cauwelaert, I.H. (1978). Shielding of phospholipid monolayers from phospholipase C hydrolysis by α -lactalbumin adsorption, *Biochemical and Biophysical Research Communications*, 84, 1088–1096.

- Hardy, E.E. Sweetsur, A.W.M., West, I.G. & Muir, D.D. (1985). Heat stability of concentrated milk: Enhancement of initial heat stability by incorporation of food grade lecithin, *Journal of Food Technology*, 20, 97–105.
- Holtorf, A.F. et al. (1951). A study of process cheese emulsifiers, *Journal of Dairy Science*, 34, 486.
- Ikeda, S. & Foegeding, E.A. (1999a). Effects of lecithin on thermally induced whey protein isolate gels, *Food Hydrocolloids*, 13, 239–244.
- Ikeda, S. & Foegeding, E.A. (1999b). Dynamic viscoelastic properties of thermally induced whey protein isolate gels with added lecithin, *Food Hydrocolloids*, 13, 245–254.
- Jost, R., Dannenberg, F. & Rosset, J. (1989). Heat-set gels based on oil/water emulsions: An application of whey protein functionality, *Food Microstructure*, 8, 23–28.
- Kabara, J.J. (1983). Medium chain fatty acids and esters, in *Antimicrobials in Food* (eds. A.L. Branen & P.M. Davidson), Marcel Dekker, New York, pp. 109–140.
- Kato, N. & Shibasaki, I. (1975). Comparison of antimicrobial activities of fatty acids and their esters, *Journal of Fermentation Technology*, 53, 793–801.
- Keeney, P.G. (1982). Development of frozen emulsions, *Food Technology*, 36, 65–70.
- Kieseker, F.G. (1983). Recombined dairy products, *CSIRO Food Research Quarterly*, 43, 25–37.
- Knightly, W.H. (1969). The role of ingredients in the formulation of coffee whiteners, *Food Technology*, 23, 37–48.
- Knipschildt, M.E. & Andersen, G.G. (1994). Drying of milk and milk products, in *Modern Dairy Technology Volume 1. Advances in Milk Processing* (ed. R.K. Robinson), Chapman and Hall, London, pp. 159–254.
- Korver, O. & Meder, H. (1974). The influence of lysolecithin on the complex formation between β -lactoglobulin and κ -casein, *Journal of Dairy Research*, 41, 9–17.
- Krog, N. (1977). Functions of emulsifiers in food systems, *Journal of the American Oil Chemists Society*, 54, 124–131.
- Krog, N. & Barfod, N.M. (1990). Interfacial properties of emulsifier/protein films related to food emulsions, *AIChE Symposium Series*, 86, 1–6.
- Krog, N. & Sparsø, F.V. (2005). Food emulsifiers: Their chemical and physical properties, in *Food Emulsions* (eds. S. Friberg, K. Larsson & J. Sjöblom), 4th edition, Marcel Dekker, New York, pp. 45–91.
- Krog, N., Barfod, N.M. & Bucheim, W. (1986). Protein-fat-surfactant interactions in whippable emulsions, in *Food Emulsions and Foams*, (ed. E. Dickinson), Royal Society of Chemistry, London, pp. 144–157.
- Langton, M. & Hermansson, A. M. (1992). Fine-stranded and particulate gels of beta-lactoglobulin and whey-protein at varying pH. *Food Hydrocolloids*, 5, 523–539.
- Larsson, K. & Dejmek, P. (1990). Crystal and liquid crystal structures of lipids, in *Food Emulsions* (eds. K. Larsson and S. Friberg), Marcel Dekker, New York, pp. 97–125.
- Lee, S.K., Klostermeyer, H., Schrader, K. & Bucheim, W. (1996). Rheology and microstructure of model processed cheese containing small molecular weight surfactants, *Nahrung*, 40, 189–194.
- Leo, A. & Betscher, J.J. (1971). Use of sodium stearyl-2-lactylate to improve the lipoprotein membrane in non-dairy coffee whiteners, *Food Technology*, 4, 70–78.
- Leviton, A. & Pallansch, M.J. (1962). High temperature short-time sterilized evaporated milk. IV. The retardation of gelation with condensed polyphosphates, manganous ions, polyhydric compounds and phosphatides, *Journal of Dairy Science*, 45, 1045–1056.
- Lin, P.M. & Leeder, J.G. (1974). Mechanism of emulsifier action in an ice cream system, *Journal of Food Science*, 39, 108–111.
- Lobato-Calleros, C., Robles-Martinez, J.C., Caballero-Perez, J.F., Aguirre-Mandujano, E. & Vernon-Carter, E.J. (2001). Fat replacers in low-fat Mexican Manchego cheese, *Journal of Texture Studies*, 32, 1–14.
- Labato-Calleros, C., Velázquez-Valera, J. Sánchez-García, J. & Vernon-Carter, E.J. (2003). Dynamic rheology of Mexican Manchego cheese-like products containing Canola oil and emulsifier blends. *Food Research International*, 36, 81–90.
- Lutton, E.S., Stauffer, C.E., Martin, J.B. & Fehl, A.J. (1969). Solid and liquid monomolecular films at oil/water interfaces, *Journal of Colloid and Interface Science*, 30, 283–295.

- Makino, S. & Moriyama, R. (1991). Interactions of proteins with sucrose esters, in *Microemulsions and Emulsions in Foods* (eds. M. El-Nokaly & D. Cornell), American Chemical Society Symposium Series, Washington, DC, Vol. 448, p. 182.
- Mangino M.E. (1992). Gelation of whey protein concentrates, *Food Technology*, 46, 114–117.
- Maxcy, R.B. & Sommer, H.H. (1954). Fat separation in evaporated milk. III. Gravity separation and heat stability, *Journal of Dairy Science*, 37, 1061–1070.
- Mayhill, P.G. & Newstead, D.F. (1992). The effect of milk fat fractions and emulsifier type on creaming in normal-solids UHT recombined milk, *Milchwissenschaft*, 47, 75–79.
- McClements, D.J. (2002a). Colloidal basis of emulsion colour, *Current Opinion in Colloid and Interface Science*, 7, 451–455.
- McClements, D.J. (2002b). Theoretical prediction of emulsion colour, *Advances in Colloid and Interface Science*, 97, 63–89.
- McClements, D.J., Chantrapornchai, W. & Clydesdale, F. (1998). Prediction of food emulsion colour using light scattering theory, *Journal of Food Science*, 63, 935–939.
- McRae, C.H. & Muir, D.D. (1992). Heat stability of recombined milk: Influence of lecithins on the heat coagulation time-pH profile, *Journal of Dairy Research*, 59, 177–185.
- McPherson, A.V., Dash, M.C. & Kitchen, B.J. (1984). Isolation and composition of milk fat globule membrane material II. From homogenized and ultra heat treated milk, *Journal of Dairy Research*, 51, 289–297.
- Miller, D.E. & Werstak, C.E. (1983). U.S. Patent 4,415,600, July 27th.
- Morr, C.V. (1992). Improving the texture and functionality of whey protein concentrate, *Food Technology*, 46, 110–113.
- Morr, C.V. & Ha, E.Y. (1993). Whey protein concentrates and isolates: Processing and functional properties, *Critical Reviews in Food Science and Nutrition*, 33, 431–476.
- Newstead, D.F., Sanderson, W.B. & Conaghan, E.F. (1977). Effects of whey protein concentration and heat treatment on the heat stability of concentrated and unconcentrated milk, *New Zealand Journal of Dairy Science and Technology*, 12, 29–36.
- Pearce, K.N. (1978). Study of some factors affecting the heat stability of milk, *20th International Conference Dairy Congress, Paris*, E, 250–251.
- Puyol, P., Perez, M.D., Burgos, J. & Calvo, M. (1998). Effect of the binding of palmitic acid to β -lactoglobulin on its gelation properties, *International Dairy Journal*, 8, 119–123.
- Rivas, H.J. & Sherman, P. (1984). Soy and meat proteins as emulsion stabilizers. 4. The stability and interfacial rheology of o/w emulsions stabilized by soy and meat protein fractions, *Colloids and Surfaces*, 11, 155–171.
- Rosenthal, I. (1991). *Milk and Dairy Products. Properties and Processing*, VCH Publishers, Weinheim, Germany.
- Segall, K.I. & Goff, H.D. (1999). Influence of adsorbed milk protein type and surface concentration on the quiescent and shear stability of butteroil emulsions, *International Dairy Journal*, 9, 683–691.
- Segall, K.I. & Goff, H.D. (2002a). Secondary adsorption of milk proteins from the serum to the interface in dairy emulsions: Effect on emulsion properties and possible means of reduction, *International Dairy Journal*, 12, 889–897.
- Segall, K.I. & Goff, H.D. (2002b). A modified ice cream processing routine that promotes fat destabilization in the absence of added emulsifier, *International Dairy Journal*, 12, 1013–1018.
- Shalabi, S.I. & Fox, P.F. (1982). Heat stability of milk: Influence of cationic detergents on pH sensitivity, *Journal of Dairy Research*, 49, 597–605.
- Shibasaki, I. (1979). Antimicrobial activity of fatty acids and their esters. A review, *Hakkokogaku*, 57, 164–176.
- Shimp, L.A. (1982). Process cheese principles, *Food Technology*, 39, 63–70.
- Si, J.Q. (1991). The production of dairy analogue products using emulsifiers, stabilizers and flavours, in *Milk Fat Production, Technology and Utilization* (eds. K.K. Rajah & K.J. Burgess), The Society of Dairy Technology, Huntingdon, pp. 112–121.

- Sims, R.J. (1989). Spray dried emulsions, in *Food Emulsifiers, Chemistry, Technology, Functional Properties and Applications* (eds. G. Charalambous & G. Doxastakis), Elsevier, Amsterdam, pp. 495–509.
- Singh, H. & Creamer, L.K. (1992). Heat stability of milk, in *Advanced Dairy Chemistry 1. Proteins* (ed. P.F. Fox), Elsevier, London, pp. 621–656.
- Singh, H. & Tokley, R.P. (1990). Effects of preheat treatments and buttermilk addition on the seasonal variations in the heat stability of recombined evaporated milk and reconstituted concentrated milk, *The Australian Journal of Dairy Technology*, 45, 10–16.
- Singh, H., Sharma, R. & Tokley, R.P. (1992). Influence of incorporation of soya lecithin into skim milk powder on the heat stability of recombined evaporated milk, *The Australian Journal of Dairy Technology*, 47, 33–37.
- Sjollem, A. (1987). Recombination of milk and dairy ingredients into milk, cream, condensed milk and evaporated milk, in *Milk—The Vital Force*, Reidel Publishing, Boston, MA, pp. 251–257.
- Swaisgood, H.E. (1992). Chemistry of the caseins, in *Advanced Dairy Chemistry 1. Proteins* (ed. P.F. Fox), Elsevier, London, pp. 63–110.
- Thomas, M.A., Newell, G., Abad, G.A. & Turner, A.D. (1980). Effect of emulsifying salts on objective and subjective properties of processed cheese, *Journal of Food Science*, 45, 458–459, 466.
- Thomé, K.E. & Eriksson, G. (1973). The foaming properties of cream 2. The effect of surface active agents, especially phospholipids and lipoproteins, on the whippability of cream, *Milchwissenschaft*, 28, 554–558.
- Tormo, R., Pota, N., Infante, D., Moran, J., Martin, B. & Bergada, A. (1998). Protein in infant formulas. Future aspects of development, *Early Human Development*, 53, S165–S172.
- Tsuchido, T., Saeki, T. & Shibasaki, I. (1981). Death kinetics of *Escherichia coli* in a combined treatment with heat and monolaurin, *Journal of Food Safety*, 3, 57–68.
- Tsuchido, T., Takano, M. & Shibasaki, I. (1983). Inhibitory effect of sucrose esters of fatty acids on intact heated bacterial spores, *Journal of Antibacterial and Antifungal Agents*, 11, 567–573.
- Tsuchido, T., Anh, Y.H. & Takano, M. (1987). Lysis of *Bacillus subtilis* cells by glycerol and sucrose esters of fatty acids, *Applied and Environmental Microbiology*, 53, 505–508.
- Tunick, M.H., Malin, E., Smith, P.W., Shieh, J.J., Sullivan, B.C., Mackey, K.L. & Webb, D. (1999). The smart fat makeover, *Prevention*, 1, 134–141.
- Van Boekel, M.A.J.S. (1980). The Influence of Fat Crystals in the Oil Phase on Stability of Oil-in-Water Emulsions, *PhD Thesis*, Wageningen Agricultural University, The Netherlands.
- Varnan, A.H. & Sutherland, J.P. (1994). *Milk and Milk Products. Technology, Chemistry and Microbiology*, Chapman and Hall, London.
- Vial, Ch, Thakur, R.K., Djelveh, G & Picgirard, L. (2006a). Continuous manufacturing of a light-texture foamed fresh cheese by dispersion of a gas phase. I. Influence of process parameters. *Journal of Food Engineering*, 77, 1–33.
- Vial, Ch, Thakur, R.K., A. Pérez Quintáns, Djelveh, G & Picgirard, L. (2006a). Continuous manufacturing of a light-textured foamed fresh cheese by dispersion of a gas phase. II. Influence of formation. *Journal of Food Engineering*, 77, 14–26.
- Vodickova, M., & Forman, L. (1984). Use of buttermilk in quality improvement of ice cream, *Veda a Vyzkum v Potravinarskem Prumyslu*, 30, 213–229.
- Walstra, P. (1987). Physical principles of emulsion science, in *Food Structure and Behaviour* (eds. J.M.V. Blanshard & P. Lillford), Academic Press, New York, pp. 87–106.
- Walstra, P. & Jenness, R. (1984). *Dairy Chemistry and Physics*, Wiley, New York.
- Westerbeek, J.M.M. & Prins, A. (1991). Function of α -tending emulsifiers and proteins in whipable emulsions, in *Food Polymers, Gels and Colloids* (ed. E. Dickinson), Royal Society of Chemistry, London, pp. 147–158.
- Zakharova, N.P. et al. (1979a). The calcium-phosphorous ratio in processed cheese, *Trudy-Vsesoyuznyi-Nauchno-issledovatel'skii-Institu-Maslodel'noi-I-Syrodel'noi-Promyshlennosti-Nauchno-proizvodstvennogo-Ob "edineniya"- 'Uglich'*, 27, 105–108, 121 (In Russian).

- Zakharova, N.P. et al. (1979b). Method for increasing the hydrophilic properties of cheese mass, *Trudy-Vsesoyuznyi-Nauchno-issledovatel'skii-Institu-Maslodel'noi-I-Syrodel'noi-Promyshlennosti-Nauchno-proizvodstvennogo-Ob "edineniya"-Uglich'*, 27, 108–111 (In Russian).
- Zadow, J.G. (1982). Recombined milks and creams, *International Dairy Federation Bulletin*, 142, 33–46.
- Zhang, Z. & Goff, H.D. (2005). On fat destabilization and composition of the air interface in ice cream containing saturated and unsaturated monoglyceride, *International Dairy Journal*, 15, 495–500.

Chapter 8

Emulsifiers in Infant Nutritional Products

Séamus L. McSweeney

8.1 Introduction

Infant nutritional products are specially formulated milks for babies and young children. These important nutritional products are available in several forms including convenient ready-to-feed liquid products, concentrated liquid products and powders that are reconstituted for consumption. The formation and stabilisation of an oil-in-water (o/w) emulsion is an integral step in the manufacture of all of these products; this is generally achieved by homogenising the oil phase, usually a blend of vegetable oils such as palm, coconut, soybean and sunflower oils, in an aqueous phase consisting mainly of carbohydrate, proteins, minerals and vitamins. The proteins together with low molecular weight food grade emulsifiers form a membrane that stabilises the oil droplets against coalescence.

This review will include some background information on the various types of nutritional products and before describing the role of emulsifiers in infant nutritional products, some background on the various production processes involved will be outlined, with emphasis on emulsion formation and stabilisation. The typical protein sources and low molecular weight emulsifiers available for use in these products will be considered in the context of the regulatory guidelines and restrictions. Finally, the functionality of emulsifiers, both protein and non-protein types, in the formation and stabilisation of emulsions will be discussed.

8.2 Types of Infant Nutritional Products

A first age-infant formula is intended for consumption by infants from birth to ~4–6 months of age. The majority of formulae in this category are, in essence, reformulated bovine milk, which has been modified to reflect the energy content and nutrient profile of human milk. Diluting the protein content, replacing the milk fat with vegetable oils and altering the mineral and vitamin profile of bovine milk are important features of this reformulation. In addition, the whey protein: casein (W:C) ratio may be adapted to reflect the ratio in human milk. This is achieved by

enriching the formula with whey proteins, thus converting the W: C ratio from that of bovine milk, which is approximately 20:80, to that of human milk, which is 60:40. The enrichment of infant formula with selected whey proteins, such as α -lactalbumin (a-lac), that are more abundant in human milk than in bovine milk has been a recent innovation.

In the cases of infants for whom the standard milk protein based first age formula is not suitable, other options are available. Formulae based on isolated soy protein are available for infants who display intolerance to milk protein. Where the carbohydrate source is other than lactose, soy protein based formulae may also be suitable for infants who display lactose intolerance. Lactose-free milk protein based formulae are available for infants who are lactose-intolerant but who can tolerate milk protein. Formulae based on hydrolysed proteins are available for infants who display milk protein allergy or intolerance. These formulae are classified according to the degree of protein hydrolysis as 'extensively' or 'partially' hydrolysed protein products. Hypoallergenic formulae containing extensively-hydrolysed proteins are generally recommended for atopic infants who have a hereditary pre-disposition toward developing certain hypersensitivity reactions upon exposure to specific antigens. These formulae are typically bitter due to the exposure of hydrophobic amino acids. More palatable formulae, based on partial protein hydrolysates (90% peptides <6kDa), have been shown to delay or prevent the onset of allergies in sensitive infants. Only pure amino acid mixtures are considered non-allergenic and elemental diets containing free amino acids are prescribed for infants with highly allergic conditions. Some infants, for example those classed as 'small for gestational age' have increased nutritional requirements and high-caloric, or nutrient dense formulae may be prescribed. Infants that are prone to gastro-oesophageal reflux (GOR), i.e. the involuntary passage of gastric contents into the oesophagus, may be fed formulae that develop a high viscosity in the infants stomach. These formulae contain permitted hydrocolloids such as starch or locust bean gum. Infants that are born premature, conventionally defined as low birth weight (LBW), require a special diet in order to survive and achieve the growth and development rates of normal infants. In hospitals, LBW infants may be fed formulae that contain greater amounts of protein, vitamins, minerals and calories than standard infant formulae to address the high nutrient needs and rapid growth of these infants. A 'post discharge formula' (PDF) is available for the LBW infant leaving the hospital environment. This is a nutrient-enriched formula generally intermediate in composition between preterm and term formulae (Lucas et al., 2001; Carver et al., 2001). Generally, the milk of a mother that has delivered a preterm infant is more nutrient dense than regular term milk. The milk may not however be able to support growth at the intrauterine rate and it may be beneficial to enrich the milk with a nutritional preparation known as 'human milk fortifier' (HMF). HMF formulae supplement human milk with protein, minerals, in particular calcium, and vitamins.

When the infant has been introduced to some solid foods, at ~4–6 months of age, a 'follow-on' formula may be provided as a complimentary food source. Follow-on formulae generally contain more protein, less fat and more carbohydrate than standard first age formula (Table 8.1). Follow-on formulae are designed to provide the

Table 8.1 Typical composition (per 100 ml) of some infant nutritional products

Formula type	Energy (kcal)	Protein (g)	Fat (g)	Carbohydrate (g)
First age (whey dominant)	66–68	1.4–1.7	3.4–3.9	7.0–7.6
First age (casein dominant)	65–69	1.5–1.7	3.4–3.8	7.0–7.5
First age (soy protein based)	65–68	1.8	3.6–3.7	6.7–6.9
Second age 'Follow on'	65–70	2.1–2.3	3.0–3.6	6.6–8.0
'Nutrient dense'	91	2.0	4.9	9.8
LBW	80	1.9–2.4	4.2–4.4	7.9–8.6
Growing up milk	100	3.5–3.7	3.3–3.5	13.6–13.8

infant with a superior nutritional source than bovine milk. Specially formulated milks are now being designed for toddlers and young children that range in age from approximately 3–7 years. These milks, commonly referred to as 'growing up milks', are similar in composition to follow-on formulae. Vanilla, chocolate and a range of fruit flavourings are commonly added to enhance the taste and aroma of these products.

In recent years, nutritional preparations for pregnant and lactating women have become available. There is a wide variety of these products available in different presentations such as multi-vitamin and mineral tablets or capsules, or beverages enriched in these nutrients.

National and international regulations and guidelines have been designed to ensure a safe and adequate nutritional intake for infants and children fed these nutritional products. Furthermore, limits have been set on the amount of processing aids, including emulsifiers that may be used during the manufacture of these products. The regulations and guidelines on permitted emulsifiers will be discussed below.

8.3 Emulsion Formation and Stabilisation

Processes used in the manufacture of infant nutritional products are based on the concept that the products must be nutritionally adequate and microbiologically safe for infants to consume. Thus, steps that eliminate or restrict microbiological growth are central to production processes. The processing technology for each specific formula is proprietary to the manufacturer but, in general, it involves the preservation of an o/w emulsion by dehydration in the case of powders products or, sterilisation in the case of ready-to-feed or concentrated liquid products. Powdered nutritional products may be produced using three general types of processes. The first process involves dry blending dehydrated ingredients to constitute a uniform formula. The second process involves hydrating and wet-mixing the ingredients and then drying the resultant mixture, usually by spray drying. In another process, which involves a combination of the two processes described above, a base powder is first produced by wet-mixing and spray drying the fat and protein ingredients and

then dry blending the remaining ingredients (carbohydrate, minerals and vitamins) to create a final formula. Liquid nutritional products are available in a ready-to-feed format or as a concentrated liquid, which requires dilution, normally 1:1, with water. The manufacturing processes used for these products are similar to those used in the manufacture of recombined milk. The production of recombined milk has been reviewed extensively in the literature (Zadow, 1982, Kieseker, 1983, Sjollem, 1987).

The formation of a stable o/w emulsion in which the fat or oil phase is uniformly distributed throughout the formula is a common pre-requisite of both the powder and liquid production processes. In the case of dry blended formulae, the fat is already emulsified within a carrier system, usually one or more of the protein sources. In the case of liquid products and products prepared by the wet-mixing/spray drying system, a fluid fat blend is dispersed and emulsified in an aqueous system consisting of the proteins, carbohydrates and other minor ingredients such as minerals, vitamins and processing aids including emulsifiers. The mixture is then homogenised to form a uniform mixture with small fat droplets (typically $<1\ \mu\text{m}$) (Fig. 8.1).

Homogenisation is normally achieved in dairy processes, including the production of infant nutritional products, by conventional valve homogenisers in which fat globules are forced through a small orifice under high pressure. The combination of shear forces and impact forces reduces large fat globules into smaller one. Microfluidisation is an alternative homogenising process. In this process, the mixture enters an interaction chamber, which has fixed-geometry micro-channels that divides the product into

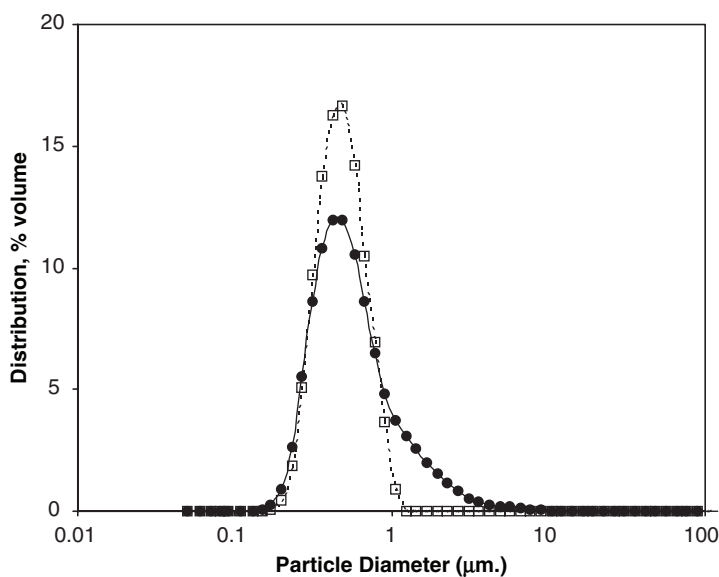

Fig. 8.1 Fat globule size distribution profile of an infant nutritional product analysed post-homogenisation, but prior to UHT-processing (■) and after UHT-processing (●)

tiny streams. The streams accelerate to a very high velocity as they flow through the interaction chamber. The system is designed such that these streams collide with each other and under these conditions shear and impact forces create very small particles. A cooling coil may or may not be present after the interaction chamber. Homogenisation with a microfluidiser is usually performed at higher pressures than is used in conventional valve homogenisation (Olson et al., 2004).

After the formation of the o/w emulsion, it undergoes sterilisation or dehydration to inactivate microorganisms. Thus, the emulsion formed must be capable of withstanding the associated pumping, shearing and thermal treatments.

In the production of powdered infant nutritional products, the o/w emulsion is normally heat treated to destroy pathogenic bacteria and evaporated prior to the dehydration step. Generally, the emulsion is evaporated in a multi-effect continuous system at 40–70 °C to increase the solids content of the emulsion to ~50–58% (w/w). An ultra-high-temperature (UHT) treatment (e.g. 135–150 °C for 3–5 s) may be applied prior to drying. The final step involves the dehydration of the emulsion until a low moisture content, typically <3%, is achieved. Spray drying is a common large scale drying system used to dry heat sensitive powders such as infant formula. The emulsion is atomised into minute droplets that fall through the drying chamber concurrently with hot air. Evaporation of water from the droplets takes place rapidly due to the large surface area. The resultant powder particles are conveyed and filled into containers such as cans or pouches. Apart from the nutritional and microbial quality, the dehydrated emulsion must be easy to reconstitute in luke-warm water and when reconstituted must be free of lumps and other defects such as free fat, greasiness and white flecks that float on the surface and adhere to the sides of the containers. Sliwinski et al. (2003) studied the effects of spray drying on the properties of emulsions (20%, w/w, soybean oil; 2.4%, w/w, protein) prepared from skim milk powder (SMP) alone, whey protein isolate (WPI) alone or SMP/WPI blends. Spray drying and reconstitution lead to a slight increase in the fat globule size of casein-dominant emulsions and a greater increase for the whey dominant emulsions. The reader is referred Pisecky (1997) and Masters (2002) for more details on the fundamentals and practice of spray drying.

In the production of liquid nutritional products, the o/w emulsion is sterilised. This is achieved by thermal treatments such as UHT processing (e.g. 135–150 °C for 3–5 s) or in-container retort sterilisation (e.g. 120 °C for 5–10 min) or a combination of these processes. Thus, the emulsion must be sufficiently heat-stable to withstand such severe thermal processes. The heat stability of the emulsions is closely related to the heat stability of the protein system and dependant on formulation variables such as the amount of protein and the sources used, fat content, pH and ionic strength (McSweeney et al., 2004).

In infant nutritional products, if the emulsion is not sufficiently heat stable, fat globule aggregation occurs as a result of interfacial protein-protein reactions to form clusters of fat globules. These fat globule aggregates, typically in the range 10–100 µm or larger cream rapidly and thus, shelf life is reduced (McSweeney et al., 2004). The installation of an aseptic homogeniser after the UHT step is an effective way to disrupt these fat globule aggregates. In extreme cases, if the emulsion is not

sufficiently heat stable to survive the thermal processing, the product coagulates and is destroyed upon sterilisation.

8.4 Emulsifying Ingredients in Infant Nutritional Products

The emulsifiers that are used in the production of infant nutritional products may be classified into two general categories; the proteins and the non-protein emulsifiers. The non-protein emulsifiers together with the hydrocolloids are usually classed in regulations as food additives.

8.4.1 Protein-Based Emulsifiers

A list of ingredients that are common protein sources in infant nutritional products is outlined in Table 8.2. Bovine milk proteins are widely used in the production of infant nutritional products.

Adapted (i.e. whey protein dominant) first-age infant formulae are generally based on a combination of skim milk and whey protein. Demineralised whey, prepared by nanofiltration, electrodialysis or by ion exchange chromatography or some combination of these methods, or whey protein concentrates prepared by membrane separation techniques, are common whey protein sources. It has long been recognised that the levels of the individual whey proteins in human and bovine milk are quite different. Human milk contains higher levels of α -lactalbumin, lactoferrin and other minor whey proteins, such as secretory immunoglobulin A, than bovine milk. In addition, β -lactoglobulins the most abundant whey protein in bovine milk is absent from human milk. This has led to the development of protein fractions enriched in the whey proteins abundant in human milk, particularly α -lactalbumin (Lein, 2003, O'Callaghan & Wallingford, 2002) specially designed for infant formulae. Lactose-free

Table 8.2 Protein ingredients commonly used in infant nutritional products

Name	Typical application
Skim milk powder	Infant formulae, follow-on formulae
Demineralised whey	Infant formulae
Whey protein concentrate	Infant formulae, follow-on formulae
α -Lactalbumin enriched/ β -lactoglobulin reduced whey protein concentrates	Infant formulae
Milk protein isolate	Lactose free infant formulae
Soy protein isolate	Infant formulae for infants intolerant of dairy proteins
Partially and extensively hydrolysed proteins (whey protein, casein, soy)	Hypoallergenic infant formulae
Sodium-, Calcium caseinates	Infant formulae, follow-on formulae

formulations are based on milk protein- and whey protein concentrates or isolates from which the lactose has been removed by membrane filtration or enzymatic hydrolysis. Formulations devoid of dairy proteins and lactose are based on isolated soy protein. The protein source, soy protein isolate, typically contains 80–90% protein. The production of ingredients for formulae based on partially or extensively hydrolysed proteins generally involves enzymatic hydrolysis of proteins (casein, whey protein or soy protein) to peptides of low molecular weight followed by ultra-filtration to remove unhydrolysed protein and large polypeptides. Elemental nutritional products contain free amino acids and are devoid of protein or peptides. The non-protein emulsifiers are the sole emulsifying agents in these products.

8.4.2 Non-Protein Emulsifiers

The non-protein emulsifiers, or low molecular weight surfactants that are permitted in infant formulae, consumed in the EU are listed in Table 8.3. Scientific committees that advise on the types and levels of emulsifiers permitted in infant nutritional products work on the principle that it is prudent to keep the number of additives to the minimum necessary (Scientific Committee for Food, European Commission, 1994). The producers of infant formula take into account the considerable amount of safety studies

Table 8.3 Emulsifiers permitted in infant nutritional products

E. No.	Name	Maximum level	Application
E322	Lecithins	^a 1 g/L	Infant formulae and follow-on formulae
E472c	Mono and diglycerides	^a 4 g/L 5 g/L	Infant formulae and follow-on formulae for special medical purposes
E471c	Citric acid esters of mono- and diglycerides of fatty acids	^a 9 g/L	Infant formulae and follow-on formulae (in products containing hydrolysed proteins, peptides or amino acids)
E473	Sucrose esters of fatty acids	^a 120 mg/L	Infant formulae and follow-on formulae (in products containing hydrolysed proteins, peptides or amino acids)
E1450	Starch sodium octenyl succinate	20 g/L	Infant formulae and follow-on formulae for special medical purposes

Adapted from Commission of the European Communities (1991, 1999)

^a If more than one of the substances E322, E471, E472c and E473 are added to a foodstuff, the maximum level established for that foodstuff for each of those is lowered with that relative part as is present of the other substance in that foodstuff

and supporting documentation, not to mention the time and cost, required to prove safety of an emulsifier in infant nutritional products. Upper limits for the food additives are established after considering factors such as acceptable daily intakes (ADIs) and technological requirements. In regular infant- and follow-on formula, the intact dairy or soy proteins are efficient emulsifiers and only limited levels of two emulsifiers (lecithin (E322) and mono-di-glycerides (E471)) are permitted (Table 8.3). However, in the case of products containing hydrolysed proteins, peptides or free amino acids, the use of non-protein emulsifiers is necessary to stabilise the emulsion. This is reflected in a more extensive list of permitted emulsifiers in these speciality infant nutritional products (Table 8.3). Thus, in addition to lecithin and mono-di-glycerides, citric acid esters of mono-di-glycerides of fatty acids (also known as CITREM (E472c), sucrose esters of fatty acids (E473) and/or starch sodium octenyl succinate (E1450) may be used in certain types of formulae. Another emulsifier, not listed in Table 8.3 is 'mono- and di-acetylated tartaric acid esters of mono- and diglycerides' (E472e) (also known as DATEM), is approved for use in special infant formulae based on crystalline amino acids (FSANZ, 2000, Canadian Food & Drugs Act, 2003).

Lecithin is widely used as an emulsifier in the food industry. Vegetable-based lecithin is commonly produced as a by-product of vegetable oil processing. Soy lecithin, from soybean oil is the most widely used surfactant ingredient in the food industry (Stauffer, 1999). It is a crude mixture of phospholipids, glycolipids, triglycerides, carbohydrates and traces of sterols, free fatty acids and carotenoids. Crude mixtures from different geographical regions may be blended to give a consistent phospholipid composition and thus, functionality. It may be modified enzymatically through hydrolysis or chemically by hydroxylation, acylation or hydrogenation. The neutral lipids, mainly triglycerides are soluble in acetone and thus may be removed from the crude lecithin mixture to yield a product enriched in the polar lipids (phospholipids and glycolipids) by a process known as de-oiling. The production of lecithin fractions with a certain phospholipid profile, for e.g. a phosphatidylcholine enriched lecithin fraction, is possible due to the differences in the solubility of the phospholipids in ethanol. Lecithin may also be isolated from egg usually by a combined extraction with ethanol and acetone (Bueschelberger, 2004). The phospholipids in vegetable-based lecithin are primarily phosphatidylcholine (PC), phosphatidylethanolamine (PE), phosphatidylinositol (PI) and phosphatidic acid (PA) but only PC and PE predominate in egg lecithin. Egg lecithin is often used in the production of infant formula, as it is a source of the long-chain polyunsaturated fatty acids arachidonic acid and docosahexaenoic acid. Natural lecithins have intermediate hydrophile-lipophile balance (HLB) values of ~8 (McClements, 2005).

Mono-di-glycerides are produced by the interesterification of triglycerides with glycerol at high temperatures (200–250 °C) under alkaline catalysis. Commercial grade mono-di-glycerides are typically, a mixture of 45–55% monoglycerides, 38–35% diglycerides, 8–12% triglycerides and 1–7% free glycerol (Moonen & Bas, 2004). Mono-di-glycerides are oil-soluble surfactants with relatively low HLB values (McClements, 2005) and are widely used in the formulation of dairy emulsions (Dickinson, 1997).

CITREM is formed by the esterification of citric acid and fatty acids with glycerol or by the reaction of a mixture of mono- and diglycerides with citric acid.

This emulsifier is dispersible in hot water and soluble in edible oils. It is an ionic oil-in-water emulsifier (Gaupp & Adams, 2004).

DATEM is formed by the esterification of mono- and di-acetyl tartaric acids and fatty acids with glycerol. The emulsifier is soluble in hot and cold water and partially solubility in warm oils. DATEM is an ionic o/w emulsifier and are more hydrophilic than its constituent mono- and di-glycerides (Gaupp & Adams, 2004).

Sucrose esters of fatty acids are non-ionic compounds synthesised by the esterification of fatty acids or natural glycerides with sucrose. The emulsification properties are dependent on the type of fatty acid that is reacted with sucrose. Emulsifiers that span the hydrophilic-lipophilic (HLB) from 1–16 can be formed by reacting fatty acids in the C₈-C₂₂ range with sucrose. Relatively hydrophilic emulsifiers (for use in w/o emulsions) can be produced by reacting short chain fatty acids with sucrose and relatively lipophilic emulsifiers (for use in o/w emulsions) can be produced by reacting long chain fatty acids, most commonly palmitic (C_{16:0}), oleic (C_{18:0}) or stearic (C_{18:1}), with sucrose (Nelen & Cooper, 2004). These emulsifiers are tasteless, odourless and display a capacity to inhibit microbial growth (Fontecha & Swaisgood, 1994).

Starch octenyl succinate anhydride (OSA Starch) is made by treating starch with the hydrophobic n-octenyl succinic anhydride at pH 8–8.5. This starch derivative is anionic due to a carboxyl group and hydrophobic due to the C₈ unsaturated alkene chain. OSA starch is highly soluble in water, and the solution is an opaque suspension (Viswanathan, 1999).

8.5 Stabilising Agents Used in Infant Nutritional Products

As with emulsifiers, hydrocolloids are regulated as food additives. The hydrocolloids that are permitted in infant formulae, for consumption within the EU are listed in Table 8.4. Further to this list, starch may be used as a source of carbohydrate and is permitted up to a maximum level of 0.2 g/L and 30% of the total carbohydrate in infant formula.

Starches and gums may be chemically or enzymatically modified to insert a lipophilic group. For example, alginic acid may be esterified with propylene glycol to yield propylene glycol alginate (E405). Other regulatory agencies such as Codex Alimentarius (Codex Alimentarius Commission, 1981) permit the modified starches including distarch phosphate (E1412), acetylated distarch phosphate (E1414), phosphated distarch phosphate (E1413) and hydroxyl propyl starch (E1400) to first age infant formula.

8.6 Emulsifier Functionality in Infant Nutritional Products

8.6.1 Aspects of Stability

Infant nutritional products must meet stringent quality criteria concerning nutrient composition, microbiology, sensory (colour, mouthfeel, odour taste) and appearance. Although emulsions are inherently unstable systems, nevertheless they can be

Table 8.4 Hydrocolloids permitted in infant nutritional products

E. No.	Name	Maximum level	Application
E412	Guar gum	1 g/L	Infant formulae (where the liquid product contains partially hydrolysed proteins)
		1 g/L	Follow on formula
		10 g/L	From birth onwards in products in liquid formulae containing hydrolysed proteins, peptides or amino acids
E440	Pectins	5 g/L	In acidified follow-on formulae only
		10 g/L	From birth onwards in products used in cases of gastro-intestinal disorders
E407	Carrageenan	0.3 g/L	Follow on formula
E410	Locust bean gum	1 g/L	Follow on formula
		10 g/L	From birth onwards in products for reduction of gastro-oesophageal reflux
E401	Sodium alginate	1 g/L	From 4 months onwards in special food products with adapted composition, required for metabolic disorders and for general tube feeding
E405	Propane 1,2-diolagnate	200 mg/L	From 12 months onwards in specialised diets intended for young children who have cow's milk intolerance or inborn errors of metabolism
E415	Xanthan gum	1.2 g/L	From birth onwards for use in products based on amino acids or peptides for use with patients who have problems with impairment of the gastro-intestinal tract, protein malabsorption or inborn errors of metabolism

Adapted from Commission of the European Communities (1991, 1999)

manufactured to be stable over the shelf-life, which is quite long in the case of infant nutritional products; generally 1–2 years for sterilised liquid emulsions and up to 3 years for powder products. At the end of shelf life the emulsion must have acceptable stability.

Ready-to-feed infant nutritional products are susceptible to similar instability problems as recombined milks products and beverage emulsions. Common defects include greasiness or 'oiling off', creaming, fat flecks, ringing, phase separation, fat creep and sedimentation. 'Oiling off' refers to the formation of an oil slick or beads on the surface of the product and is due to non-emulsified fat.

Steps should be taken to minimise creaming because it influences many product features. On shaking, the cream layer may break up into small fat flecks that float on the surface. Alternatively, the fat may form a solid clump, which may prove difficult to re-disperse. A fat ring or collar may remain on the side of the container after shaking. Fat may also ‘creep-up’ along the neck of the container to generate an undesirable appearance; this fat may also prove difficult to re-disperse upon shaking. Creaming may result in the formation of distinct phases that appear different; one towards the top of the product that is enriched in fat and is generally whitish and another phase below which is depleted in fat and is generally more translucent in appearance. If the product contains insoluble minerals, a layer of sediment may form over time on the base. In the case of powder products, the dehydrated emulsion does not undergo significant changes throughout the shelf life and its reconstituted appearance will reflect the quality of the emulsion that was dried. Generally, creaming is not an issue as the product is consumed within hours of rehydration but if the emulsion was of a poor quality before drying, undesirable features such as ‘oiling off’, greasiness and white flecks may become evident after reconstitution.

An understanding of the factors that influence the stability of infant nutritional emulsions is required in order to develop products that display an excellent appearance over a lengthy shelf life.

8.6.2 Emulsifier Functionality

The function of emulsifiers in infant nutritional products is to facilitate the formation of a stable emulsion and to improve stability. This is achieved during the homogenisation process when the emulsifiers (both protein and non-protein types) diffuse to and adsorb at the newly formed fat droplets to form an interfacial film or membrane. The stability of each oil droplet is dependant on the nature and extent of its interaction with neighbouring droplets in the continuous phase, which in turn is determined by the conformation, structure, electrical charge and the mechanical and rheological properties of the interfacial membrane (Das & Kinsella, 1990). The properties of the interfacial membrane will depend on the proportions of each type of surface active component and their surface active properties; initially the most surface active component predominates at the interface and low molecular weight surfactants generally displace proteins over time (Euston, 1997).

At fluid/fluid interfaces proteins lose their tertiary structure, unfold, and rearrange so that hydrophobic segments of the polypeptide chain orient towards the oil phase and hydrophilic segments orient towards the aqueous phase, and eventually form a cohesive film around the fat droplet. The interfacial properties of proteins, in general, are described in a comprehensive review by Das & Kinsella (1990). Recent aspects of protein-stabilised emulsions were reviewed by McClements (2004). The milk proteins are excellent emulsifiers because they are amphiphathic

molecules containing polar and non-polar regions. For general reviews on the emulsifying properties of milk proteins, see Dickinson (2001, 2004).

The emulsifiers commonly used in the production of infant nutritional products are listed in Table 8.5. Regular infant nutritional products can rely on the inherent emulsification properties of intact milk proteins to form stable emulsions. Nutritional products that contain hydrolysed proteins, peptides or free amino acids, especially in a ready-to-feed format, require non-protein emulsifiers to create stable emulsions. These low molecular weight surfactants consist of a hydrophilic 'head' group and a lipophilic 'tail' group (McClements, 2005, Hasenhuettl, 1997, Faergemand & Krog, 2003). The head group may be non-ionic (e.g. monoglycerides, sucrose esters of fatty acids) anionic (e.g. CITREM, DATEM) or zwitterionic, containing both positive and negative charges on the same molecule (e.g. lecithin) (McClements, 2005). The tail group usually consists of one or more hydrocarbon chains. The non-protein surfactants adsorb at the oil-water interface with the hydrophilic head oriented towards the water phase and the hydrophobic head oriented towards the lipid phase. During homogenisation, the presence of non-protein surfactants leads to a more rapid reduction in interfacial tension than with milk proteins alone, which facilitates the formation of smaller droplets, and thus, an emulsion with increased stability towards creaming (Dickinson et al., 1989a).

The composition, structure and rheology of the adsorbed layer that is formed by a mixture of proteins and non-protein surfactants is usually quite different from that formed from proteins alone. Consequently, the competitive adsorption of protein and non-protein surfactants, the displacement of protein by non-protein surfactants and the interaction of non-protein surfactants with interfacial protein, are topics that have been extensively researched. In most cases, the competitive adsorption of protein and non-protein surfactants reduces the protein surface coverage at the o/w interface (de Feijter et al., 1987, Courthaudon et al., 1991, Dickinson et al., 1993b, Euston et al., 1995). The interfacial film may be rendered stronger or weaker than with proteins alone because of surfactant/protein competition. The amount of protein displaced depends on surfactant type and concentration, time, and environmental factors such as temperature. As a rule, non-ionic water-soluble surfactants (e.g. sucrose esters) are more efficient at displacing proteins from the interface than non-ionic oil-soluble emulsifiers are (e.g. monoglycerides) (Dickinson, 1995; Oortwijn & Walstra, 1979; Dickinson & Tanai, 1992, Dickinson et al., 1993a,b,c, Euston et al., 1995). Some non-protein surfactants interact and form complexes with proteins at the interface without necessarily displacing them (Doxastakis & Sherman, 1984).

Non-protein surfactant emulsifiers can also interact with proteins adsorbed at the interface and non-adsorbed proteins in the aqueous phase. Dickinson (1993) described the binding of charged ionic surfactant molecules with protein as occurring in two separate phases. Initially, the polar region of the surfactant binds to specific charged sites on the protein surface, such as cationic regions owing to the presence of Lys, His or Arg residues and the non-polar section of the surfactant binds to hydrophobic regions on the protein surface. Then, the protein unfolds to expose its hydrophobic interior and hence further binding sites for the hydrophobic section of the surfactant. Non-ionic surfactants, on the other hand, exhibit non-specific hydro-

Table 8.5 Emulsifying ingredients (both protein and non-protein) and stabilisers used in a selection of some commercially available infant formula

Formula type	Brand name	Producer	Emulsifiers used			Format
			Protein	Non-protein	Stabiliser	
First age and follow-formula based on intact proteins						
Whey dominant	S26	Wyeth Nutrition	Skim milk, Reduced minerals whey	Soy lecithin, mono-di-glycerides	–	Powder, ready-to-feed
Whey dominant	Similac PM 60/40	Ross-Abbot	WPC, sodium caseinate	–	–	Powder
Whey dominant	NAN	Nestle	Reduced minerals WPC, skim milk powder (SMP)	–	–	Powder
Whey dominant	Aptamil Extra	Milupa	Whey powder, skim milk	Soy lecithin	–	Powder
Casein dominant	Similac Advance	Ross-Abbot	Skim milk	Soy lecithin and mono-di-glycerides (in liquids only)	–	Powder, ready-to-feed, concentrate
Formula containing hydrolysed proteins, peptides or amino acids						
First age	S26 HA	Wyeth Nutrition	Partially hydrolysed whey protein	CITREM	–	Powder, ready-to-feed
FSMP	Peptamen	Nestle	Partially hydrolysed whey protein	Soy lecithin	Corn starch, guar gum	powder
First age (lactose-free, soy protein based)	Goodstart 2 Supreme Soy	Nestle	Enzymatically hydrolysed soy protein isolate (SPI)	Soy lecithin	–	powder
Follow-on formula	Goodstart 2	Nestle	Enzymatically hydrolysed Reduced minerals WPC (amino acid-based)	–	Carrageenan (liquids only)	Powder, ready-to-feed, concentrate
Infant formula (based on free amino acids)	Neocate	SHS	–	CITREM	–	–
Medical food for children ages 1–10	Neocate Junior	SHS	(amino acid-based)	DATEM	Propylene Glycol Alginate	powder

(continued)

Table 8.5 (continued)

Formula type	Brand name	Producer	Emulsifiers used			Stabiliser	Format
			Protein	Non-protein	DATEM		
Medical food for children ages 1-10	Neocate One+	SHS	(amino acid-based)	mono-di-glycerides,	DATM	Propylene Glycol Alginat	powder
Medical food for children ages 1-10	Pediatric E028	SHS	(amino acid-based)	mono-di-glycerides,	DATM	Sodium Carboxy methyl cel-lulose	ready-to-feed
Medical food, based on free amino acids and non-dairy hydrolysates, for children ages 1-10	Pepdite One+	SHS	Hydrolyzed pork and soy Proteins (and free amino acids)	DATM		-	powder
First age, when dominant	Enfamil Gentlease LIPIL	Mead Johnson	Partially hydrolysed skim milk and whey protein solids	mono-di-glycerides,	DATM	Propylene Glycol Alginat	powder
	Enfamil Pregestimil LIPIL	Mead Johnson	Casein hydrolysate	Acetylated monoglycerides N(powder only)		Starch in powder Starch and carrageenan in liquids	Powder, ready-to-feed, concentrate
First age	Similac Alimentum Advance	Ross-Abbot	Casein hydrolysates (supplemented with free amino acids)	DATM (powder only)		Xanthan gum in powder, Starch and carrageenan in liquids	ready-to-feed, powder
	Nutramigen LIPIL	Mead Johnson	extensively hydrolyzed casein (supplemented with free amino acids)	Acetylated monoglycerides		Starch in powder Starch and carrageenan in liquids	Powder, ready-to-feed, concentrate

phobic interactions (Dickinson, 1993). Several studies have demonstrated that surfactants interact with dairy proteins (Brown et al., 1982, 1983; Fontecha & Swaisgood, 1994, 1995; Sarker et al., 1995; Antipova et al., 2001; Deep & Ahluwalia, 2001; Istarova et al., 2005).

As well as determining the composition, structure, thickness, rheology and charge of the interfacial layer, the non-protein surfactants influence the properties of emulsions in other ways. Dickinson et al. (1989a) described some mechanisms that explain how non-protein surfactants influence the stability of dairy emulsions. Certain non-protein surfactants such as mono-glycerides affect fat crystallisation and crystal structure in emulsion droplets (Euston, 1997), which may destabilise the o/w emulsions (Boode & Walstra, 1993). The non-protein surfactants influence the viscosity of the aqueous phase through the formation of self-bodying mesophase structures (Dickinson et al., 1989a). The nature of the interfacial membrane also influences the susceptibility of the emulsion to fat oxidation. As already mentioned, the influence of surfactants on heat stability is of particular relevance to the manufacture of heat-sterilised recombined milk based beverages such as ready to feed infant formulae.

8.6.2.1 Functional Properties of Proteins as Emulsifiers

Emulsifying Properties of Non-Hydrolysed Milk Protein Sources

The emulsifying characteristics of many of the individual caseins, in particular β -casein, have been studied in model emulsion systems (Atkinson et al., 1995; Brooksbank et al., 1993; Courthaudon et al., 1991; Dalgleish, 1993; Dickinson et al., 1993a,b; Dickinson et al., 1988; Leermakers et al., 1996; Leaver & Dalgleish, 1992). Similarly, the emulsifying characteristics of the individual whey proteins, including β -lactoglobulin (β -lg), α -lac and bovine serum albumin (BSA) have been studied (Atkinson et al., 1995; Dickinson & Gelin, 1992; Eaglesham et al., 1992; Dickinson & Matsumura, 1991, 1994; Dickinson & Iveson, 1993; Dickinson et al., 1993). Some important, emulsion-related, characteristics of the milk proteins are listed below:

- The individual caseins are relatively unstructured proteins with an amphipathic nature and thus, have high surface activities.
- The whey proteins are also amphipathic but in contrast to the caseins feature a globular structure and generally diffuse more slowly than the caseins to the o/w interface.
- Whey proteins form more viscous interfacial films than caseins (Boyd et al., 1973).
- Caseins preferentially adsorb at the o/w interface over whey proteins during homogenisation in emulsions prepared with skim milk (Oortwijn & Walstra, 1979, 1982; Britten & Giroux, 1991; Sharma & Dalgleish, 1993; Sharma & Singh 1998; Brun & Dalgleish, 1999; Dalgleish et al., 2002).

The proteins used in studies of simple model emulsions quite often consist of one protein type that is in the native form, whereas commercially available ingredients

consist of many individual protein types that may be denatured during the isolation or manufacture of the ingredient or, denatured during the manufacture of the nutritional product. Therefore, some studies have focussed on complex food-type emulsions containing commercially available milk protein ingredients including those used in the production of infant nutritional products (Britten & Giroux, 1991; Sharma & Singh, 1998; Euston & Hirst, 1999, 2000; Sourdet et al., 2002; McSweeney et al., 2004).

Protein structure and flexibility are known to have an important influence on the emulsifying ability of milk protein ingredients. The caseins in micellar casein products such as skim milk powder (SMP) and milk protein concentrate (MPC) exist as colloidal particles; casein micelles, which are composed of individual submicelles linked together by calcium bridges. Non-micellar casein (as found in products such as sodium caseinate or total milk proteinate) and the globular whey proteins, as found in whey protein concentrates (WPC), may be considered as flexible proteins that can readily unfold to form an interfacial film. Micellar casein behaves differently at interfaces to non-micellar casein and whey proteins. The calcium bridges restrict the extent to which casein micelles unfold at fluid/fluid interfaces and thus, the effective number of protein 'particles' available for adsorption is lower for micellar casein than for non-micellar casein. Furthermore, there may also be a reduced tendency for micellar casein to adsorb at interfaces as the more hydrophobic groups are located at the core of the micelles, and the surface of the micelle is not very hydrophobic (Dalglish, 1996). Nevertheless, micellar casein can accumulate at the o/w interface by dissociating into submicelles (Courthaudon et al., 1999; Walstra et al., 1999). In general, a protein in the micellar or aggregated state forms emulsions with a higher surface coverage, a higher surface viscosity and greater adsorbed layer dimensions than protein in the non-aggregated state such as non-micellar casein or globular whey proteins (Oortwijn & Walstra, 1979). Mulvihill and Murphy (1991) found that micellar casein and calcium caseinate were not as surface active as sodium caseinate, but the micellar casein products formed more stable emulsions than sodium caseinate. Sharma and Singh (1998) found that emulsions (4%, w/w, fat), prepared using skim milk powder (SMP) had higher protein concentrations ($\sim 6 \text{ mg m}^{-2}$) at the interface than emulsions prepared using sodium caseinate or whey protein isolate (WPI) ($\sim 2 \text{ mg m}^{-2}$). The addition of WPI reduced the surface protein concentration in SMP-stabilised emulsions but had no effect on sodium caseinate stabilised emulsions. Euston and Hirst (1999, 2000) found that for a given protein concentration, non-aggregated caseinate and whey proteins facilitated the formation of o/w emulsions (20%, w/w, oil) with a finer range of droplet sizes than for aggregated caseins products such as milk protein concentrate (MPC) and SMP. However, the emulsions made from MPC and SMP had a higher surface coverage and were less susceptible to creaming than emulsions made using caseinate. Caseinate-stabilised emulsions can exhibit depletion flocculation (Dickinson et al., 1997); at a certain concentration the non-adsorbed casein in the emulsions forms micelle-like aggregates which in turn causes depletion flocculation leading to reduced creaming stability (Euston & Hirst, 1999).

The extent of thermal processing during the manufacture of milk protein products can influence their emulsifying properties, particularly if the heating results in whey protein denaturation. Upon heating to $>70\text{--}75\text{ }^{\circ}\text{C}$, whey proteins denature and the surface activity of the aggregates of denatured proteins is largely unknown and dependant on the process conditions used during manufacture such as temperatures, duration of heating, pH and ionic strength. Mellema and Isenbart (2004) studied the effect of heating milk proteins (WPC, SMP) on the rheological properties of o/w interfaces. It was found that preheating ($85\text{ }^{\circ}\text{C}$ for 20 min) a WPC solution (0.7%, w/w) resulted in denaturation and aggregation but the aggregates formed were surface active since denatured whey proteins are not stable in solution and tend to aggregate or adsorb. The interfacial properties of SMP were largely unaffected by preheating (45 or $85\text{ }^{\circ}\text{C}$ for 20 min) or by the type of powder used (low, medium or high heat SMP).

Those infant nutritional products, that have an increased ratio of W:C compared to bovine milk, are formulated by combining whey protein sources with casein sources in the appropriate ratios. The emulsifying properties of whey protein and casein blends have been studied (Britten & Giroux, 1991; Sourdet et al., 2002). Britten and Giroux (1991) found that as the whey protein: casein (W: C) ratio in emulsions (30%, w/w soya oil; 1%, w/w, protein) increased, the surface protein concentration decreased. The protein sources used were sodium caseinate alone, WPI alone or sodium caseinate/WPI blends. Emulsions containing casein alone were the most susceptible to creaming and coalescence. The extent of emulsion destabilisation decreased when the protein solutions were heated ($80\text{ }^{\circ}\text{C} \times 30\text{ min}$) before emulsion formation. Sourdet et al. (2002) reported that emulsions (9%, w/w, palm kernel oil), prepared using WPI as the sole protein source had a lower protein surface coverage than similar emulsions prepared using a SMP/WPI blend (60:40 W: C ratio) or SMP alone. Furthermore, emulsions containing WPI alone had aggregates of fat globules, whereas WPI/SMP-containing or, SMP-containing emulsions had fat globules with a narrow, mono-modal particle size distribution. In the study by Sliwinski et al. (2003), it was found that spray drying and reconstitution emulsions (20%, w/w, soybean oil; 2.4% protein) prepared from SMP alone, WPI alone or SMP/WPI blends had little impact on the amount of adsorbed protein. Characterisation of the interfacial proteins showed that the composition of the adsorbed layer of casein-dominant emulsions was largely unaffected by spray drying and reconstitution. However, emulsions containing between 50–90% whey protein, had increased levels of whey protein at the interface after spray drying and reconstitution, even though the amount of adsorbed protein did not change, i.e. casein was displaced by whey protein. The authors postulated that non-adsorbed caseins could prevent the adsorbed caseins from being displaced by aggregating whey proteins in the casein-dominant emulsions.

Recently, novel milk protein fractions, such as α -lactalbumin (α -lac) enriched whey protein fractions, have been developed especially for use in infant nutritional products. These fractionated ingredients may be less efficient emulsifiers than whey protein; it has been demonstrated that β -lg is more surface active than α -lac (Yamauchi et al., 1980; Srinivasan et al., 1996; Sharma & Singh, 1998).

Emulsifying Properties of Hydrolysed Milk Protein Sources

The emulsifying properties of hydrolysed proteins are related to the degree of hydrolysis (DH), the molecular weight distribution (MWD) and the amphiphilicity of the peptides formed (Rahali et al., 2000; Van der Ven et al., 2001; Euston et al., 2001b). The literature is somewhat ambiguous about the emulsion-forming ability of hydrolysates of casein or whey protein and the stability of resultant emulsions. Some studies have reported that the emulsion forming ability of low DH hydrolysates of casein (Chobert et al., 1988a,b; Haque & Mozaffar, 1992) or whey protein (Haque & Mozaffar, 1992; Vojdani & Whitaker, 1994) is improved compared to the intact proteins that the hydrolysates were derived from but other studies have reported that the emulsion forming ability is reduced after hydrolysis of casein (Chobert et al., 1988a; Slattery & Fitzgerald, 1998; Euston et al., 2001b). In general, intact milk proteins form more stable emulsions than hydrolysates of milk proteins (Haque & Mozaffar, 1992; Agboola & Dalgleish, 1996). Euston et al. (2001b) showed that emulsifying properties of hydrolysates of whey protein concentrate (WPC) were dependant on the degree of hydrolysis. Whey protein hydrolysates (WPH) with low DH values (4–10%) displayed poorer emulsifying ability than non-hydrolyzed WPC. Hydrolysates with intermediate DH values (10–27%) showed improved emulsifying ability but hydrolysates with high DH values (27–35%) displayed poor emulsifying ability and emulsion stability. In a comparison of casein and whey protein hydrolysates prepared using commercially available enzymes, Van der Ven et al. (2001) found that whey protein hydrolysates formed emulsions with bimodal droplet size distributions, indicating poor emulsion-forming ability while some casein hydrolysates demonstrated similar emulsion-forming ability to that of intact casein. The emulsion stability was related to the apparent molecular weight distribution of hydrolysates; emulsions formed using hydrolysates with a relatively high amount of peptides >2 kDa were more stable than emulsions formed using hydrolysates which contained smaller peptides. Lajoie et al. (2001) evaluated the role of cationic and anionic peptidic fractions isolated from an ultrafiltered whey protein tryptic hydrolysate mixture by anion- or cation-exchange chromatography as potential replacers of carrageenan in a model infant formula. The addition of the cationic peptidic fractions reduced emulsion stability compared to the control with carrageenan, whereas the creaming rate was reduced when the anionic peptidic fractions were used in the formulation. The properties of formula emulsions (4%, v/w, sunflower oil) prepared from WPI or WPH at 3.7 and 4.9% (w/w) were investigated by Tirok et al. (2001). WPH-containing emulsions had a significantly higher mean droplet size were more susceptible to coalescence and creaming than WPI-containing emulsions. However, WPH-based emulsions could be stabilised against creaming and coalescence, when a low level of protein was used in combination with hydrolysed lecithin and glucose syrup.

Emulsifying Properties of Soy Protein Sources

Non-dairy infant nutritional products normally use soy protein isolate (SPI) as the protein source. The soybean proteins have traditionally been classified according to ultracentrifugal analysis into 2S, 7S, 11S and 15S fractions; the 7S (β -conglycinin) and 11S (glycinin) fractions are the predominant proteins (Aoki et al., 1980). The soy proteins are also amphipathic proteins containing both hydrophobic and hydrophilic amino acids and hence can act as emulsifiers. Mitidieri and Wagner (2002) and Palazolo et al. (2003) found that oil-in-water emulsions, stabilised using native SPI (at concentrations in the range 1–10 mg ml⁻¹) were very stable against coalescence but emulsions prepared with denatured SPI were unstable. These results were linked to the nature of the interfacial protein layer formed; due to the compact globular structure and low surface hydrophobicity of the native SPI, a monolayer protein film formed around the oil droplets that sustained emulsion stability. The denatured SPI, on the other hand, formed a weak multi-layer film that was susceptible to stress.

8.6.2.2 Functional Properties of Non-Protein Emulsifiers

Lecithin

As lecithin has intermediate solubility characteristics and HLB numbers (~8), it is not particularly suitable for stabilising either o/w or w/o emulsions when used in isolation (McClements, 2005) but it may be effective when used in combination with other surfactants, such as proteins in the case of infant nutritional products.

The main surface-active components of lecithin, the phospholipids (PC, PE, PI and PA) consist of a hydrophilic, or polar, head group and a hydrophobic tail group (the fatty acid chains). Thus, at o/w interfaces, polar head groups orientate towards the water phase and fatty acid chains orientate towards the lipid phase. As lecithin contains mostly unsaturated fatty acids, it is functional at ambient temperatures unlike the other widely used emulsifier in infant nutritional products, the mono-di-glycerides, which must be melted at ~70 °C to function.

In the manufacture of infant nutritional products, lecithin is added primarily to improve emulsion stability. During emulsion formation and subsequent processing and storage, phospholipids influence emulsion properties through a combination of several factors including electrostatic and van der Waals forces, protein displacement and the formation of protein/phospholipid complexes. The net effect is a reduction in the interfacial tension (Yamamoto & Araki, 1997) and oil droplet size (Dickinson & Iveson, 1993; Sunder et al., 2001) and consequently, increased emulsion stability.

The inclusion of charged phospholipids at the o/w interfaces influences the electrostatic repulsion between oil droplets (Arts et al., 1994; van Niewenhuyzen

& Szuhaj, 1998; Rydhag & Wilton, 1981). The emulsion stabilising effect of zwitterionic phospholipids (PC, PE) is related to the formation of a lamellar liquid crystalline phase around the oil droplets, which causes a local viscosity increase, and the van der Waals attraction force between pairs of droplets is largely reduced (Friberg & Solans, 1986).

The displacement of proteins by lecithin is complex due to variability in the head group and fatty acid chain types of the constituent phospholipids, the formation of a range of liquid crystalline phases in water and phospholipid/protein interactions (Dickinson, 1997). In general, phospholipids are not very effective at completely displacing milk proteins from the o/w interface (Dickinson & Iveson, 1993; Fang & Dalgleish, 1996a,b). For example, Courthaudon et al. (1991a) found that the addition of lecithin at high emulsifier: protein molar ratios (M_R) (>16) only lead to the partial displacement of protein from the interface of an o/w emulsion (0.4%, w/w, β -casein; 20%, w/w, oil).

The competitive adsorption at the interface between proteins and lecithin is further complicated by the interaction of lecithin with adsorbed proteins and non-adsorbed proteins in the aqueous phase (Fang & Dalgleish, 1993). Several studies have demonstrated an interaction of certain phospholipids with milk proteins in general (Korver & Meder, 1974) or specific proteins such as β -lg (Brown et al., 1983; Kristensen et al., 1997; Sarker et al., 1995). The combination of interfacial protein displacement (Courthaudon et al., 1991a; Dickinson et al., 1993a) and the formation of protein/phospholipid complexes (Kristensen et al., 1997; Lefèvre & Subirade, 2001; Istarova et al., 2005) is significant in the production of thermally treated milk based products as an improvement in heat stability usually results. One of the reasons for using lecithin in ready-to-feed infant nutritional products is to increase heat stability (McSweeney et al., in press). Several studies have demonstrated that lecithin improves the heat stability of milk (Hardy et al., 1985; McCrae & Muir, 1992; Singh et al., 1992), whey protein stabilised emulsions (Jimenez-Flores et al., 2005) and other dairy based products such as an artificial coffee creamer (Van der Meeren et al., 2005). Euston et al. (2001a) noted that at the initial stages of heating an o/w emulsion (1%, w/w, whey protein; 20%, w/w, soya oil) at 100 °C, low concentrations (<0.2%, w/w) of PC accelerated the rate of heat-induced aggregation of droplets, but as heating continued beyond 60 s, PC reduced the rate of aggregation. Emulsions containing 0.5 or 1% (w/w) PC proved resistant to heat-induced fat globule aggregation. In the same study, when glycerol monostearate (GMS) was included in the emulsion at 1% (w/w) the rate of heat-induced aggregation of fat globules was accelerated compared to the control with no emulsifier.

Lecithin does not appear to be a particularly good emulsifier in emulsions containing hydrolysed proteins. A study by Tirok et al. (2001) may explain why this is the case. In the study, it was noted that emulsions (4%, w/w, sunflower oil) containing whey protein hydrolysate (3.7 or, 4.9%, w/w) and de-oiled soybean lecithin (0.48 or, 0.70%, w/w) rapidly destabilised. The results indicated that there was a preferential adsorption of lecithin over peptides and this may have resulted in a reduction in electrostatic and steric repulsion, thus, promoting coalescence. Normally, when a high concentration of non-protein emulsifier is used, multilayers

of a lamellar liquid crystalline phase increase stability (Dickinson, 2001). However, the authors postulated that the presence of WPH peptides at the interface may have interfered with the formation of such an organised structure at the interface.

Mono-Di-Glycerides

Mono-di-glycerides are non-ionic oil-soluble surfactants and are the most widely used emulsifiers in the food industry (Zielinski, 1997). As they are predominately hydrophobic and dissolve preferentially in oil, they are typically used to stabilise w/o emulsions. In the case of infant nutritional products, monoglycerides are not particularly useful when used alone, but when used in combination with other surfactants, such as proteins and/or lecithin, mono-di-glycerides act to further reduce the interfacial tension. This facilitates the formation of small oil droplets during homogenisation. Dickinson and Tanai (1992) have shown that the emulsion droplet size is reduced when mixtures of proteins and GMS are used as the emulsifiers. The formation of small oil droplets ($<1 \mu\text{m}$) is important to maintain the shelf-life stability of ready-to-feed or concentrated liquid infant nutritional products.

The disruption of adsorbed milk proteins by mono-di-glycerides has important implications for the processing and shelf life stability of emulsions. Mono-di-glycerides are known to partially displace milk proteins from o/w interfaces (Barfod et al., 1991; Krog & Larsson, 1992; Gelin et al., 1994; Pelan et al., 1997; Davies et al., 2000, 2001).

- GMS displaced a significant proportion of adsorbed milk protein in a cream liqueur emulsion system (Dickinson et al., 1989b).
- Britten and Giroux (1991) found that the inclusion of commercial grade mono-di-glycerides in emulsions (30%, w/w, soya oil; 1%, w/w, protein) prepared from WPI alone, sodium caseinate alone or, blends of WPI and sodium caseinate with various W: C ratios, reduced the surface protein load.
- Davies et al. (2001) reported that at concentrations of $2 \text{ g } 100 \text{ g}^{-1}$ in the oil phase, saturated monoglycerides (glycerol monopalmitate (GMP) or GMS) displaced more protein from a sodium caseinate stabilised o/w emulsion than the unsaturated glycerol monoolein (GMO). This effect may be explained by the differences in the properties of adsorbed layers; the fatty acid chains of the saturated monoglycerides may be able to align in more closely packed layers at the interface compared to the fatty acid chains of unsaturated monoglycerides.

Following the displacement of proteins by low-molecular weight surfactants, the mechanical strength of the interface and the orthokinetic stability of protein-stabilised emulsions is reduced (Euston, 1997). In particular, mono-di-glycerides are very effective at displacing proteins from the interface at temperatures below $\sim 15 \text{ }^\circ\text{C}$. Upon cooling, mono-di-glycerides promote fat crystallisation; emulsions with added mono-di-glycerides have higher solid fat content compared to emulsions with no added mono-di-glycerides (Davies et al., 2001; Miura et al., 2002). Saturated monoglycerides (GMS, GMP) have a greater ability to initiate fat crystallisation than unsaturated

monoglycerides such as GMO (Davies et al., 2001). The presence of fat crystals further promotes the destabilisation of emulsions under shear; fat crystals protruding from the emulsion droplet may pierce the thin interfacial film thus promoting coalescence of neighbouring droplets. Mono-di-glycerides may promote both protein displacement and fat crystallisation during the storage of infant nutritional emulsions at low storage temperatures prior to the final thermal processing or dehydration step. The net effect may be to reduce the stability of the emulsion to shearing and turbulent forces. Protein displacement by mono-di-glycerides may also influence the thermal stability of emulsions. As mentioned above, Euston et al. (2001a) found that GMS promoted the heat-induced aggregation of a whey protein stabilised emulsion.

Organic Esters of Mono-Di-Glycerides (Citrem and Datem)

CITREM (E472c) and DATEM (E472d) are used in the production of infant nutritional products based on hydrolysed proteins, peptides or amino acids (Table 8.3). Generally, the degree of protein hydrolysis in these products is such that the emulsion must be stabilised entirely by non-protein emulsifiers. CITREM and DATEM are particularly suitable for use in o/w emulsions as they have high HLB values. Thus, at the interface, the fatty acid group orientates into the oil phase while the negatively charged organic acid groups extends into the aqueous phase stabilising the emulsion through electrostatic repulsion. The electrostatic repulsion prevents coalescence and thus products with reasonably long shelf lives can be produced.

Organic esters of mono-di-glycerides are widely used in the baking industry and there is not so much information in the literature on how these ingredients behave in fluid o/w emulsions. Antipova et al. (2001) demonstrated that like other surfactants, CITREM interacts with aqueous phase proteins, in this case sodium caseinate, predominantly through hydrophobic interactions. CITREM was demonstrated to be an extremely effective emulsifier in stabilizing a model ready-to-fee infant formula emulsion containing hydrolysed whey protein; emulsions made using CITREM as the only added emulsifier had small fat globules ($<1\mu\text{m}$) and demonstrated stability towards Geaming, coalescence and retort sterilization (McSweeney, 2007). Giroux and Britten (2004) demonstrated that DATEM interacts with whey proteins to modify their structure and thermal stability and but not as extensively as sodium dodecyl sulphate (SDS) or sodium stearyl-2 lactylate (SSL).

Sucrose Esters of Fatty Acids

Sucrose esters of fatty acids (E473) may be used in the production of infant formula based on hydrolysed proteins, peptides or amino acids (Table 8.3). At the interface, the fatty acid group(s) orientates into the oil phase while the sucrose groups extend into the aqueous phase. This group of emulsifiers is not widely used in the production of infant nutritional products (Table 8.5). There is a lack of information on the literature related to the use of sucrose esters of fatty acids in fluid o/w emulsions.

Starch Octenyl Succinate Anhydride

When the starch octenyl succinate anhydride (OSA starch) macromolecule adsorbs at the o/w interface it stabilises droplets against coalescence by steric hindrance and charge repulsion. In a study, Tesch et al. (2002) demonstrated that OSA starches could replace whey proteins as emulsifiers in o/w emulsions and that unlike whey proteins, OSA starch stabilised emulsions were not susceptible to aggregation near the iso-electric point of the protein. Mahmoud (1987) reported that OSA starch was very effective in stabilising a hypoallergenic formula based on extensively hydrolysed proteins. Although a permitted ingredient in certain circumstances, OSA starch (E1450) is not a widely used ingredient in the production of infant nutritional products (Table 8.5).

8.6.3 *Function of Stabilisers*

Traditionally, hydrocolloids such as gums and starches have been regarded as thickeners. Their stabilising effect on emulsions derives from an increase in the viscosity of the aqueous phase. The kinetic motion of the droplets is reduced, resulting in a lower rate of flocculation and coalescence. As they are not true emulsifiers, they are not considered in this review.

8.7 Summary

Infant nutritional products are o/w emulsions that must maintain excellent stability throughout a long shelf life. These products are available in a ready-to-feed liquid format, as a concentrated liquid that requires dilution or, as a dehydrated powder that must be reconstituted prior to use. Regular infant nutritional products that are based on intact proteins may be stabilised by the proteins alone. Lecithin and mono-di-glycerides are non-protein emulsifiers that may be used to enhance the stability of these products, particularly, ready-to-feed or concentrated liquid products. In addition to lecithin and mono-di-glycerides, other emulsifiers (CITREM, DATEM, OSA starch and sucrose esters of fatty acids) and stabilisers are permitted for use in infant nutritional products that are based on hydrolysed proteins, peptides or amino acids. Apart from the emulsifiers used, the emulsion quality of infant nutritional products is influenced by other compositional variables; protein-stabilised emulsions are especially sensitive to pH and ionic strength effects (McClements, 2004). Therefore, infant nutritional products are formulated not only to generate a target composition (label claim) but also to have pH values and ionic strengths that coincide with optimum emulsion stability (McSweeney et al., 2004). This is achieved by selecting appropriate sources and combinations of proteins and mineral salts. The stability of the emulsion formed is dependant on the conditions during the homogenisation step (method, temperatures, pressure, number of passes)

and unit operations that thermally process the emulsion such as the terminal sterilisation step (McSweeney et al., 2004) or that dehydrate the emulsion (Sliwinski et al., 2003). Finally, emulsion quality is also influenced by environmental stress during transport and storage, such as temperature and mechanical agitation.

References

- Agboola, S.O. & Dalgleish, D.G. (1996). Enzymatic hydrolysis of milk proteins used for emulsion formation. 1. Kinetics of protein breakdown and storage stability of the emulsions. *J. Agric. Food Chem.*, **44**, 3631–3636.
- Antipova, A.S., Semenova, M.G., Belyakova, L.E. & Il'in, M.M. (2001). On relationships between molecular structure, interaction and surface behaviour in mixture: small-molecule surfactant + protein. *Colloids Surf. B Biointerfaces*, **21**, 217–230.
- Aoki, H., Taneyama, O. & Inami M. (1980). Emulsifying properties of soy proteins: Characteristics of 7S and 11S proteins. *J. Food Sci.*, **45**, 534–538.
- Arts, T.J.C., Laven, J., Voorst Vader, F. van & Kwaaitaal, T. (1994). Zeta potentials of tristearoylglycerol crystals in olive oil. *Colloid Surf. A, Physicochem. Eng. Aspects*, **85**, 149–158.
- Atkinson, P.J., Dickinson, E. Horne, D.S. & Richardson R.M. (1995). Neutron reflectivity of adsorbed β -casein and β -lactoglobulin at the air/water interface. *J. Chem. Soc. Faraday Trans.*, **91**, 2847–2854.
- Barfod, N.M., Krog, N. Larsen, G. & Buchheim, W. (1991). Effects of emulsifiers on protein/fat interaction in ice-cream mix during ageing. 1. Quantitative analyses. *Fat Sci. Technol.*, **93**, 24–29.
- Boode, K. & Walstra, P. (1993). Kinetics of partial coalescence in oil-in-water emulsions. In, *Food Colloids and Polymers: Stability and Mechanical Properties* (eds. E. Dickinson & P. Walstra), Royal Soc. Chem., Cambridge, UK, pp. 23–30.
- Boyd, J.V., Mitchell, J.R., Irons, L., Musselwhite, P.R. & Sherman, P. (1973). The mechanical properties of milk protein films spread at the air-water interface. *J. Colloid Interface Sci.*, **45**, 478–486.
- Britten, M. & Giroux, H.J. (1991). Emulsifying properties of whey protein and casein composite blends. *J. Dairy Sci.*, **74**, 3318–3325.
- Brooksbank, D.V., Davidson, C.M., Horne, D.S. & Leaver, J. (1993). Influence of electrostatic interactions on β -casein layers adsorbed on polystyrene lattices. *J. Chem. Soc. Faraday Trans.*, **89**, 3419–3425.
- Brown, E.M., Carroll, R.J., Pfeffer, P.E. & Sampugna, J. (1983). Complex formation in sonicated mixtures of β -lactoglobulin and phosphatidylcholine. *Lipids*, **18**, 111–118.
- Brown, E.M., Sampugna, J., Pfeffer, P.E. & Carroll, R.J. (1982). Interaction of phosphatidylcholine with beta-lactoglobulin. *Biophys. J.*, **37**, 71–72.
- Brun, J.M. & Dalgleish, D.G. (1999). Some effects of heat on the competitive adsorption of caseins and whey proteins in oil-in-water emulsions. *Int. Dairy J.*, **9**, 323–327.
- Bueschelberger, H.-G. (2004). Lecithins. In, *Emulsifiers in Food Technology* (ed. Robert J. Whitehurst), Blackwell Publishing Ltd., Oxford, UK, pp. 1–39.
- Canadian Food & Drugs Act (2003). Part B. Food and Drug Regulations. Division 24. Foods for special dietary use. Department of Health, Ottawa, Ontario, Canada.
- Carver, J.D., Wu, P.Y., Hall, R.T., Ziegler, E.E., Sosa, R., Jacobs, J., Baggs, G., Auestad, N. & Lloyd, B. (2001). Growth of preterm infants fed nutrient-enriched or term formula after hospital discharge. *Paediatrics*, **107**, 683–689.
- Chobert, J.M., Bertrand-Harb, C. & Nicolas, M.G. (1988a). Solubility and emulsifying properties of caseins and whey proteins modified enzymatically by trypsin. *J. Agric. Food Chem.*, **36**, 883–892.

- Chobert, J.M., Sitohy, M.Z. & Whitaker, J.R. (1988b). Solubility and emulsifying properties of caseins modified enzymatically by *Staphylococcus aureus* V8 protease. *J. Agric. Food Chem.*, **36**, 220–224.
- Codex Alimentarius Commission (1981). Codex standard for infant formula, Codex Stan. 72–1981, as amended in 1983, 1985, 1987 and 1997. Food and Agriculture Organization of the United Nations and World Health Organization, Rome, Italy.
- Commission of the European Communities (1991). Commission directive of 14 May 1991 on infant formulae and follow-on formulae. 92/321/EEC. (Last consolidated 25 May 1999). *Official J. Eur. Comm.*, **L175**, 35–49.
- Commission of the European Communities (1999). Commission directive of 25 March 1999 on Dietary Foods for Special Medical Purposes. 1999/21/EC. *Official J. Eur. Comm.*, **L91/29**, 29–36.
- Courthaudon, J.-L., Dickinson, E. & Christie, W.W. (1991). Competitive adsorption of lecithin and β -casein in oil-in-water emulsions. *J. Agric. Food Chem.*, **39**, 1365–1368.
- Courthaudon, J.-L., Girardet, J.M., Campagne, S., Rouhier, L.M. & Campagne, S., Linden, G. & Lorient, D. (1999). Surface active and emulsifying properties of casein micelles compared to those of sodium caseinate. *Int. Dairy J.*, **9**, 411–412.
- Dalgleish, D.G. (1993). The sizes and conformations of the proteins in adsorbed layers of individual caseins on lattices and in oil-in-water emulsions. *Colloids Surf. B. Biointerfaces*, **1**, 1–8.
- Dalgleish, D.G. (1996). Food emulsions. In *Emulsions and Emulsion Stability* (ed. J. Sjöblom), Marcel Dekker Inc, New York, pp. 287–321.
- Dalgleish, D.G., Goff, H.D., Brun, J.M. & Luan, B. (2002). Exchange reactions between whey proteins and caseins in heated soya oil-in-water emulsion systems—overall aspects of the reaction. *Food Hydrocolloids*, **16**, 303–311.
- Das, K.P. & Kinsella, J.E. (1990). Stability of food emulsions: Physicochemical role of protein and nonprotein emulsifiers. *Adv. Food Nutr. Res.*, **34**, 81–129.
- Davies, E., Dickinson, E. & Bee, R.D. (2000). Shear stability of sodium caseinate emulsions containing monoglyceride and triglyceride crystals. *Food Hydrocolloids*, **14**, 145–153.
- Davies, E., Dickinson, E. & Bee, R.D. (2001). Orthokinetic destabilization of emulsions by saturated and unsaturated monoglycerides. *Int. Dairy J.*, **11**, 827–836.
- Deep, S. & Ahluwalia, J.C. (2001). Interaction of bovine serum albumin with anionic surfactants. *Phys. Chem. Chem. Phys.*, **3**, 4583–4591.
- de Feijter, J.A., Benjamins, J. & Tamboer, M. (1987). Adsorption displacement of proteins by surfactants in oil-in-water emulsions. *Colloids Surf.*, **27**, 243–266.
- Dickinson, E. (1993). Proteins in solution and at interfaces. In *Interactions of Surfactants with Polymers and Proteins* (eds. E.D. Goddard & K.P. Ananthapadmanabhan), CRC Press, Boca Raton, FL., p 295.
- Dickinson, E. (1995). Recent trends in food colloids research. In *Food Macromolecules and Colloids* (eds. E. Dickinson & D. Lorient), Royal Soc. Chem., Cambridge, United Kingdom, p 1.
- Dickinson, E. (1997). Properties of emulsions stabilized with milk proteins: overview of some recent developments. *J. Dairy Sci.*, **80**, 2607–2619.
- Dickinson, E. (2001). Milk protein interfacial layers and the relationship to emulsion stability and rheology. *Colloids Surf. B. Biointerfaces*, **20**, 197–210.
- Dickinson, E. (2004). Properties of emulsions stabilized with milk proteins: Overview of some recent developments. *J. Dairy Sci.*, **80**, 2607–2619.
- Dickinson, E., & Gelin, J.-L. (1992). Influence of emulsifier on competitive adsorption of α -casein and β -lactoglobulin in oil-in-water emulsions. *Colloids Surf. B. Biointerfaces*, **63**, 329–335.
- Dickinson, E., Golding, M. & Povey, M.J.W. (1997). Creaming and flocculation of oil-in-water emulsions containing sodium caseinate. *J. Colloid Interface Sci.*, **185**, 515–529.
- Dickinson, E., Home, D.S. & Richardson, R.M. (1993a). Neutron reflectivity study of the competitive adsorption of β -casein and water-soluble surfactant at the planar air-water interface. *Food Hydrocolloids*, **7**, 497–505.

- Dickinson, E. & Iveson, G. (1993). Absorbed films of β -lactoglobulin and lecithin at the hydrocarbon-water and triglyceride-water interfaces. *Food Hydrocolloids*, **6**, 533–541.
- Dickinson, E. & Matsumura, Y. (1991). Time-dependent polymerisation of β -lactoglobulin through disulphide bonds at the oil-water interface in emulsions. *Int. J. Biol. Macromol.*, **13**, 26–30.
- Dickinson, E. & Matsumura, Y. (1994). Proteins at liquid interfaces: Role of the molten globule state. *Colloids Surf. B. Biointerfaces*, **3**, 1–17.
- Dickinson, E., Mauffret, A. Rolfe, S.E & Woskett, C.M. (1989a). Adsorption at interfaces in dairy systems. *J. Soc. Dairy Technol.*, **42**, 18–22.
- Dickinson, E., Narhan, S.K. & Stainsby, G. (1989b). Stability of cream liqueurs containing low-molecular-weight surfactants. *J. Food Sci.*, **54**, 77–81.
- Dickinson, E., Owusu, R.K., Tan, S. & Williams, A. (1993b). Oil-soluble surfactants have little effect on competitive adsorption of alpha-lactalbumin and beta-lactoglobulin in emulsions. *J. Food Sci.*, **58**, 295–298.
- Dickinson, E., Owusu, R.K. & Williams, A. (1993c). Orthokinetic destabilization of a protein-stabilized emulsion by a water-soluble surfactant. *J. Chem. Soc. Faraday Trans.*, **89**, 865–66.
- Dickinson, E., Rolfe, S.E. & Dalgleish, D.G. (1988). Competitive adsorption of α_{s1} -casein and β -casein in oil-in-water emulsions. *Food Hydrocolloids*, **2**, 397–405.
- Dickinson, E. & Tanai, S. (1992). Protein displacement from the emulsion droplet surface by oil-soluble and water-soluble surfactants. *J. Agric. Food Chem.*, **40**, 179–183.
- Doxastakis G. & Sherman, P. (1984). The interaction of sodium caseinate with monoglyceride and diglyceride at the oil-water interface and its effect on interfacial rheological properties. *Colloid Polym. Sci.*, **264**, 254–259.
- Eaglesham, A., Herrington, T.M. & Penfold, J. (1992). A neutron reflectivity study of a spread monolayer of bovine serum albumin. *Colloids Surf.*, **65**, 9.
- Euston, S.E., Singh, H., Munro, P.A. & Dalgleish, D.G. (1995). Competitive adsorption between sodium caseinate and oil-soluble and water-soluble surfactants in oil-in-water emulsions. *J. Food Sci.*, **60**, 1124–1131.
- Euston, S.R. (1997). Emulsifiers in Dairy Products and Dairy Substitutes. In, *Food Emulsifiers and their Applications* (eds. G.L. Hassenheutl & R. Hartel), Chapman & Hall, New York, pp. 173–210.
- Euston, S.R. & Hirst, R.L. (1999). Comparison of the concentration-dependent emulsifying properties of protein products containing aggregated and non-aggregated milk protein. *Int. Dairy J.*, **9**, 693–701.
- Euston, S.R. & Hirst, R.L. (2000). The emulsifying properties of commercial milk protein products in simple oil-in-water emulsions and in a model food system. *J. Food Sci.*, **65**, 934–940.
- Euston, S.R., Finnigan, S.R. & Hirst, R.L. (2001a). Aggregation kinetics of heated whey protein-stabilized emulsions: effect of low-molecular weight emulsifiers. *Food Hydrocolloids*, **15**, 253–262.
- Euston, S.R., Finnigan, S.R. & Hirst, R.L. (2001b). Heat-induced destabilization of oil-in-water emulsions formed from hydrolyzed whey protein. *J. Agric. Food Chem.*, **49**, 5576–5583.
- Faergemand, M. & Krog, N. (2003). Using emulsifiers to improve food texture. In, *Texture in Foods, Volume 1: Semi-Solid Foods* (ed. B.M. McKenna), CRC Press, Boca Raton, FL. Chapter 10.
- Fang, Y., & Dalgleish, D.G. (1993). Casein adsorption on the surfaces of oil-in-water emulsions modified by lecithin. *Colloids Surf.*, **1**, 357–364.
- Fang, Y. & Dalgleish, D.G. (1996a). Comparative effects of three different phosphatidylcholines on casein-stabilized oil-in-water emulsions. *J. Am. Oil Chem. Soc.*, **73**, 437–442.
- Fang, Y. & Dalgleish, D.G. (1996b). Competitive adsorption between dioleoylphosphatidylcholine and sodium caseinate on oil-water interfaces. *J. Agric. Food Chem.*, **44**, 59–64.
- Fontecha, J. & Swaisgood, H. (1995). Interaction of sucrose esters with skim milk proteins as characterised by size-exclusion chromatography. *J. Dairy Sci.*, **78**, 2660–2665.

- Fontecha, J. & Swaisgood, H. (1994). Interaction of sucrose esters with skim milk proteins as characterised by affinity chromatography. *J. Dairy Sci.*, **77**, 3545–3551.
- Friberg, S.E. & Solans, C. (1986). Surfactant association structures and the stability of emulsions and foams. *Langmuir*, **2**, 121–126.
- FSANZ (2000). *Australia and New Zealand Food Standards Code. Standard 2.9.1. Infant formula products*. FSANZ, Canberra, Australia.
- Gaupp, R. & Adams, W. (2004). Acid esters of mono- and diglycerides. In, *Emulsifiers in Food Technology* (ed. Robert J. Whitehurst), Blackwell Publishing Ltd., pp. 59–85.
- Gelin, J.-L., Poyen, L. Courthaudon, J.-L. Le Meste, M. & Lorient, D. (1994). Structural changes in oil-in-water emulsions during the manufacture of ice cream. *Food Hydrocolloids*, **8**, 299–308.
- Giroux, H.J. & Britten, M. (2004). Heat treatment of whey proteins in the presence of anionic surfactants. *Food Hydrocolloids*, **18**, 685–692.
- Haque, Z.U. & Mozaffar, Z. (1992). Casein hydrolysate. II. Functional properties of peptides. *Food Hydrocolloids*, **5**, 559–571.
- Hardy, E.E., Sweetsur, A.W.M., West, I.G. & Muir, D.D. (1985). Heat stability of concentrated milk: enhancement of initial heat stability by incorporation of food grade lecithin. *Aust. J. Food Technol.*, **20**, 97–105.
- Hasenhuettl, G.L. (1997). Overview of food emulsifiers. In, *Food Emulsifiers and Their Applications* (eds G.L. Hasenhuettl & R.W. Hartel), Chapman & Hall, New York, NY.
- Istarova, T.A., Semenova, M.G., Sorokoumova, G.M., Selishcheva, A.A., Belyakova, L.E., Polikarpov, Y.N. & Anokhina, M.S. (2005). Effect of pH on the interactions of sodium caseinate with soy phospholipids in relation to the foaming ability of their mixtures. *Food Hydrocolloids*, **19**, 429–440.
- Jimenez-Flores, R., Ye, A. & Singh, H. (2005). Interactions of whey proteins during heat treatment of oil-in-water emulsions formed with whey protein isolate and hydroxylated lecithin. *J. Agric. Food Chem.*, **53**, 4213–4219.
- Kieseker, F.G. (1983). Recombined dairy products. *CSIRO Food Res. Q.*, **43**, 25–37.
- Korver, O. & Meder, H. (1974). The influence of lysolecithin on the complex formation between beta-lactoglobulin and kappa-casein. *J. Dairy Res.*, **41**, 9–17.
- Kristensen, A., Nylander T., Paulsson, M. & Carlsson, A. (1997). Calorimetric studies of interactions between β -lactoglobulin and phospholipids in solution. *Int. Dairy J.*, **7**, 87–92.
- Krog, N. & Larsson, K. (1992). Crystallization at interfaces in food emulsions—A general phenomenon. *Fat Sci. Technol.*, **94**, 55–57.
- Lajoie, N., Gauthier, S.F. & Pouliot, Y. (2001). Improved storage stability of model infant formula by whey peptides fractions. *J. Agric. Food Chem.*, **49**, 1999–2007.
- Leaver, J. & Dalgleish, D.G. (1992). Variations in the binding of β -casein to oil-water interfaces detected by trypsin-catalysed hydrolysis. *J. Colloid Interface Sci.*, **149**, 49–55.
- Leermakers, F.A.M., Atkinson, P.J., Dickinson, E. & Horne, D.S. (1996). Self-consistent-field modelling of adsorbed β -casein: effects of pH and ionic strength on surface coverage and density profile. *J. Colloid Interface Sci.*, **178**, 681–693.
- Lefèvre, T. & Subirade, M. (2001). Molecular structure and interaction of biopolymers as viewed by Fourier transform infrared spectroscopy: Model studies on β -lactoglobulin. *Food Hydrocolloids*, **15**, 365–376.
- Lein, E. (2003). Infant formulae with increased concentrations of α -lactalbumin. *Am. J. Clin. Nutr. (suppl.)*, **77**, 1555S–1558S.
- Lucas, A., Fewtrell, M.S., Morley, R. et al. (2001). Randomized trial of nutrient-enriched formula versus standard formula for post discharge preterm infants. *Paediatrics*, **108**, 703–711.
- Mahmoud, M.I. (1987). Enteral nutritional hypoallergenic formula. *US Patent 4,670,268*.
- Master, K. (2002). *Spray Drying in Practice*. SprayDryConsult International ApS, Charlottenlund, Denmark Publishers.
- McClements, D.J. (2004). Protein stabilized emulsions. *Curr. Opin. Colloid Interface Sci.*, **9**, 305–313.

- McClements, D.J. (2005). *Food Emulsions: Principles, Practice and Techniques*—2nd edition. (ed. D.J. McClements), CRC Press, Boca Raton, FL, Chapter 4.
- McCrae, C.H. & Muir, D.D. (1992). The influence of phospholipid classes of crude lecithin on the heat stability of recombined milk. *Milchwissenschaft*, **47**, 755–759.
- McSweeney S.L., Mulvihill, D.M. & O'Callaghan, D.M. (2004). The influence of pH on the heat-induced aggregation of model milk protein ingredient systems and model infant formula emulsions stabilized by milk protein ingredients. *Food Hydrocolloids*, **18**, 109–125.
- McSweeney, S.L. (2007). Stability of model ready-to feed infant formula emulsions. Ph. D. Thesis, National University of Ireland, Cork.
- McSweeney, S.L., Healy, R. & Mulvihill, D.M. (in press). Effect of lecithin and monoglycerides on the heat stability of a model infant formula emulsion. *Food Hydrocolloids*, Available online 7 May 2007.
- Mellema, M. & Isenbart, J.G. (2004). Effect of acidification and heating on the rheological properties of oil-water interfaces with adsorbed milk proteins. *J. Dairy Sci.*, **87**, 2769–2778.
- Mitidieri, F.E. & Wagner, J.R. (2002). Coalescence of o/w emulsions stabilized by whey and isolate soybean proteins. Influence of thermal denaturation, salt addition and competitive interfacial adsorption. *Food Res. Int.*, **35**, 547–557.
- Miura, S., Yamamoto, A. & Sato, K. (2002). Effect of monoacylglycerols on the stability of model cream using palm oil. *Eur. J. Lipid Sci. Technol.*, **104**, 819–824.
- Moonen, H. & Bas, H. (2004). Mono- and diglycerides. In, *Emulsifiers in Food Technology* (ed. R.J. Whitehurst). Blackwell Publishing Ltd., Oxford, UK, pp. 40–58.
- Mulvihill, D.M. & Murphy, P.C. (1991). Surface active and emulsifying properties of caseins/caseinates as influenced by state of aggregation. *Int. Dairy J.*, **1**, 13–37.
- Nelen, B.A.P. & Cooper, J.M. (2004). Sucrose esters. In, *Emulsifiers in Food Technology* (ed. R. J. Whitehurst), Blackwell Publishing Ltd., Oxford, UK, pp. 131–158.
- O'Callaghan, D.M. & Wallingford, J.C. (2002). Infant formulae—New developments. In, *Encyclopaedia of Dairy Science* (eds. H. Roginshki, J. Fuquay & P.F. Fox), Academic Press, Elsevier Science, London., Vol. 3, pp. 1384–1392.
- Olson, D.W., White, C.H. & Richter R.L. (2004). Effect of pressure and fat content on particle sizes in microfluidized milk. *J. Dairy Sci.*, **87**, 3217–3223.
- Oortwijn, H., & Walstra, P. (1979). Membranes of recombined fat globules. 2. Composition. *Neth. Milk Dairy J.*, **33**, 134–154.
- Oortwijn, H. & Walstra, P. (1982). Membranes of recombined fat globules. 4. Effects on properties of recombined milks. *Neth. Milk Dairy J.*, **36**, 279–290.
- Palazolo, G.G., Mitidieri, F.E. & Wagner, J.R. (2003). Relationship between interfacial behaviour of native and denatured soybean isolates and microstructure and coalescence of oil-in-water emulsions—Effect of salt and protein concentration. *Food Sci. Tech. Int.*, **9**, 409–11.
- Pelan, B.M.C., Watts, K.M., Campbell, I.J. & Lips, A. (1997). On the stability of aerated milk protein emulsions in the presence of small-molecule surfactants. In, *Food Colloids: Proteins, Lipids and Polysaccharides* (eds. E. Dickinson & B. Bergenstahl), Royal Soc. Chem., Cambridge, United Kingdom, p 55.
- Pisecky (1997). *Handbook of Milk Powder Manufacture*. Niro A/S Copenhagen, Denmark.
- Rahali, V., Chobert, J.M., Haertle, T. & Gueguen, J. (2000). Emulsification of chemical and enzymatic hydrolysates of β -lactoglobulin: characterization of the peptides adsorbed at the interface. *Nahrung*, **44**, 89–95.
- Rydhag, L. & Wilton, I. (1981). The function of phospholipids of soybean lecithin in emulsions. *J. Am. Oil Chem. Soc.*, **58**, 830–837.
- Sarker, D.K., Wilde, P.J. & Clark, D.C. 1995. Control of surfactant-induced destabilization of foams through polyphenol-mediated protein-protein interactions. *J. Agric. Food Chem.*, **43**, 295–300.
- Scientific Committee for Food, European Commission (1994). Opinion on certain additives for use in infant formulae, follow-on formulae and weaning foods. Reports of the Scientific Committee for Food (32nd series). *Office for Official Publications of the European Communities*, Luxembourg.

- Sharma, R. & Dalgleish, D.G. (1993). Interactions between milk serum proteins and synthetic fat globule membrane during heating of homogenized whole milk. *J. Agric. Food Chem.*, **41**, 1407–1412.
- Sharma, R. & Singh, H. (1998). Adsorption behaviour of commercial milk protein and milk powder products in low-fat emulsions. *Milchwissenschaft*, **53**, 373–377.
- Singh, H., Sharma, R. & Tokley, R.P. (1992). Influence of incorporation of soya lecithin into skim milk powder on the heat stability of recombined evaporated milk. *Aust. J. Dairy Technol.*, **47**, 33–37.
- Sjollem, A. (1987). Recombination of milk and dairy ingredients into milk, cream, condensed milk and evaporated milk. In, *Milk—The Vital Force*, Reidel Publishing, Boston, MA, pp. 251–257.
- Slattery, H. & Fitzgerald, R.J. (1998). Functional properties and bitterness of sodium caseinate hydrolysates prepared with a *Bacillus* proteinase. *J. Food Sci.*, **63**, 418–422.
- Sliwinski, E.L., Lavrijsen, B.W.M., Vollenbroek, J.M., van der Stege, H.J., van Boekel, M.A.J.S. & Wouters, J.T.M. (2003). Effects of spray drying on physicochemical properties of milk protein-stabilised emulsions. *J. Colloids Surf. B Biointerfaces*, **31**, 219–229.
- Sourdet, S., Relkin, P., Fosseux, P.Y. & Aubry, V. (2002). Composition of fat protein layer in complex food emulsions at various weight ratios of casein-to-whey proteins. *Lait*, **82**, 567–578.
- Srinivasan, M., Singh, H. & Munro, P.A. (1996). Sodium caseinate-stabilized emulsions: Factors affecting coverage and composition of surface proteins. *J. Agric. Food Chem.*, **44**, 3807–3811.
- Stauffer C.E. (1999). *Emulsifiers*, Eagan Press Handbook, St. Paul, MA, pp. 551–553.
- Sunder, A., Scherze, I. & Muschiolik, G. (2001). Physico-chemical characteristics of oil-in-water emulsions based on whey protein-phospholipid mixtures. *Colloids Surf. B Biointerfaces*, **21**, 75–85.
- Tesch, S., Gerhards, C. & Schubert H. (2002). Stabilization of emulsions by OSA starches. *J. Food Eng.*, **54**, 167–174.
- Tirok, S., Scherze, I. & Muschiolik, G. (2001). Behaviour of formula emulsions containing hydrolysed whey protein and various lecithins. *Colloids Surf. B Biointerfaces*, **21**, 149–162.
- Van der Meeren, P., El-Bakry, M., Neiryneck, N. & Noppe, P. (2005). Influence of hydrolyzed lecithin on protein adsorption and heat stability of a sterilised coffee cream simulant. *Int. Dairy J.*, **15**, 1235–1243.
- Van der Ven, C., Gruppen, H., de Bont, D.B.A. & Voragen, A.G.J. (2001). Emulsion properties of casein and whey protein hydrolysates and the relation with other hydrolysate characteristics. *J. Agric. Food Chem.*, **49**, 5005–5012.
- van Nieuwenhuizen, W. & Szuhaj, B.F. (1998). Effects of lecithins and proteins on the stability of emulsions. *Fett/Lipid*, **100**, 282–291.
- Viswanathan, A. (1999). Effect of degree of substitution of octenyl Succinate starch on the emulsification activity on different oil phases. *J. Polym. Environ.*, **7**, 191–196.
- Vojdani, F. & Whitaker, J.R. (1994). Chemical and enzymatic modification of proteins for improved functionality. In, *Protein functionality in food systems* (eds. N.S. Hettiarachy & G.R. Ziegler), Marcel Dekker, New York, pp. 261–310.
- Walstra, P., Guerts, T.J., Noomen, A. & van Boekel, M.A.J.S. (1999). *Dairy Technology*. Marcel Dekker, New York.
- Yamamoto, Y. & Araki, M. (1997). Effects of lecithin addition in oil or water phase on the stability of emulsions made with whey proteins. *Biosci. Biotechnol. Biochem.*, **61**, 1791–1795.
- Yamauchi, K., Shimizu, M. & Kamiya, T. (1980). Emulsifying properties of whey protein. *J. Food Sci.*, **45**, 1237–1242.
- Zadow, J.G. (1982). Recombined milks and creams. *Int. Dairy Fed. Bull.*, **142**, 33–46.
- Zielinski, R.J. (1997). Synthesis and composition of food-grade emulsifiers. In, *Food Emulsifiers and their Application*, (eds. G.L. Hasenhuettl & R.W. Hartel), Chapman & Hall, New York, pp. 11–38.

Chapter 9

Applications of Emulsifiers in Baked Foods

Frank Orthofer

9.1 Introduction

Emulsifiers are multifunctional ingredients when used in bakery products. The three major functions are (1) to assist in blending and emulsification of ingredients, (2) enhance the properties of the shortening, and (3) beneficially interact with the components of the flour and other ingredients in the mix. Some of the specific functions are uniquely described as creaming, dough conditioning or crumb softening. This chapter discusses the activity and functional role of emulsifiers in baked products.

9.2 History of Bakery Emulsifiers

The development of emulsifiers for bakery products parallel the development of shortenings. The term “shortening” was initially used to refer to the fats used to “shorten” or tenderize baked foods. The composition of the shortening has progressed from natural fats to blends of oils, hydrogenated fats and hard fats as well as trait modified oils (Orthofer, 2006a). Shortenings, once used for blends intended only for baked products, is now used to describe frying oils or almost any fat or oil used in food preparation. Shortenings intended for bakery products, however, may include additives such as emulsifiers, antioxidants, antifoam, and metal scavengers. Bakery shortenings may be the tenderizer as well as the ingredient that affects structure, stability, flavor, storage stability, eating characteristics and eye appeal. Many of the functional effects are due to, or are enhanced by, the emulsifier added as a component of the shortening.

Historically, animal fats were used for bakery products because of their natural plasticity and flavor (O’Brien, 1996). Lard was the preferred animal fat because of its pleasing flavor. With the excess of cottonseeds and cottonseed oil in the market, vegetable shortenings were developed by the cottonseed industry early in the twentieth century. Initially, cottonseed oil was blended with lard as a “lard compound” or simply “*compound shortening*.” Hydrogenation was invented in 1910. This allowed the production of vegetable based substitutes for semi sold

(plastic) animal fats and permitted the development of products with improved functional properties.

Along with the process to modify the melting properties of fats or oils (hydrogenation) came improved methods for processing the oil including refining, bleaching, and deodorization. The fully processed products possessed improved oxidative stability, uniformity and enhanced performance. Knowledge of lipid chemistry led to improvement in alcoholysis, esterification, interesterification, and isomerization. These advances in lipid chemistry led to new emulsifiers and improved shortening formulations. High ratio shortening was introduced around 1933. These shortenings contained mono- and diglycerides. The emulsifiers produced finer dispersions of fat particles in the dough giving strengthened cake batters. Stronger cake batters permitted increased water and sugar addition resulting in sweeter tasting, more tender cakes. The high-ratio shortenings possessed excellent creaming properties. Moist, high volume, fine-grained, even-textured cakes were produced. Icings were also improved (Hartnett, 1977).

Emulsifier development also advanced in the 1930s (Stauffer, 1996). Specialty shortenings were formulated. Commercial layer cakes, pound cakes, cake mixes, crème fillings, icing, whipped toppings, bread and sweet dough shortenings were created. This development of specialty emulsifiers resulted in improvements in processing and improved product performance for the retail, food service and food processing industries. In addition to the traditional plastic shortenings, liquid shortenings, fluid shortenings, and powdered products were produced (O'Brien, 1995). All these products involved formulations with emulsifiers.

9.3 Definition of Emulsifiers

Emulsifiers are surface active agents that promote the formation and stabilization of an emulsion. A surfactant is also a surface active agent. The terms emulsifiers and emulsifying agent, surfactant and surface active agent are synonymous and used interchangeably in the literature. The terms “emulsifier” and “emulsifying agents” are, strictly speaking, chemicals or compounds capable of promoting emulsions or stabilization of emulsions by their effect on interfacial tension. Surfactants for foods may include not only emulsifiers but also compounds with other functions such as protein or starch interaction.

The roles of the emulsifier and of the shortening are intimately bound in bakery products. Generally, the food emulsifiers for bakery products supplement and improve the functionality of a properly developed shortening. Emulsifiers act as lubricants, emulsify oil or fat in batters, build structure, aerate, improve eating quality, extend shelf life, modify crystallization, prevent sticking, and retain moisture. A list of emulsifiers used in shortening is given in Table 9.1. The selection, and addition of an emulsifier to a shortening base may significantly change the application of the shortening (Table 9.2).

Table 9.1 Emulsifiers used in shortenings

Mono- and diglycerides	Sorbitan monostearate
Lecithin	Polysorbate 60
Lactylated monoglyceride	Polyglycerol esters
Calcium stearoyl lactylate	Succinylated monoglycerides
Sodium stearoyl lactylate	Sodium stearoyl fumarate
Propylene glycol monoesters	Sucrose esters
Diacetyl tartaric esters of monoglycerides	Stearoyl lactylate
Ethoxylated monoglycerides	–

Table 9.2 Examples of nonemulsified and emulsified shortenings

Non-emulsified	Emulsified
All-purpose	Cake and icing
Puff pastry	Household
Pie crust	Filling
Cookie	Cake mix
Danish roll-in	Yeast raised
Donut fry	Specialty cake

9.4 Emulsifier Function in Baked Goods

Baked goods without emulsifiers have been described as tough, dry, stale, leathery, or tasteless (Brandt, 1996). Current processing, distribution and storage of baked goods requires the use of additives that maintain quality and freshness (Orthofer, 2006b). Fewer bakeries, longer distribution, and extra time before consumption requires longer shelf life of finished baked goods.

Emulsifiers are commonly used in many food products. These supplementary materials or food additives are used to

1. Compensate for variations in raw materials
2. Guarantee constant quality
3. Produce alternative products
4. Preserve freshness and eating properties
5. Facilitate processing (Schuster and Adams, 1984).

Emulsifiers promote the emulsification of oil in water. This is found for bakery emulsifiers. However, emulsification is often of secondary importance. Starch complexing, protein strengthening, and aeration may be the primary function. Fat sparing effects are also of importance.

The interaction between protein, carbohydrates, and lipids is significant for processing of wheat flour. “The flour itself exhibits interaction among components even in flour/water doughs. Starch is the major flour component followed by protein.”

The interactions between emulsifiers and flour components are multifaceted and account for the improved functionality and performance of baked products.

The use of surfactants in bakery products is regulated in most countries. The European Economic Community (EEC) number and U.S. FDA Code of Federal Regulations (21 CFR) for the most common food emulsifiers are shown in Table 9.3.

Wheat Flour	Percent
Starch	70.0–75.0
Protein	11.5–12.5
Pentosan	2.0–2.5
Lipid	1.0–1.5
Crude fiber	0.2
Ash	0.5

Table 9.3 Emulsifier function in baked goods

Emulsifier	U.S. FDA (21CFR)	EEC number
Monoglycerides and diglycerides (GRAS)	184.1505	E 471
Succinyl monoglyceride	172.830	–
Lactylated monoglyceride	172.852	E 472
Acetylated monoglyceride	172.828	E 472
Monoglyceride citrate	172.832	E 472
Monoglyceride phosphate (GRAS)	184.1521	–
Stearyl monoglyceride citrate	172.755	E 471
Diacetyl-tartrate ester of monoglyceride (GRAS)	184.1101	E 472
Polyoxyethylene monoglyceride	172.834	–
Propylene glycol monoester	172.854	E 477
Lactylated propylene glycol monoester	172.850	–
Sorbitan monostearate	172.842	E 491
Polysorbate 60	172.836	E 435
Polysorbate 65	172.836	E 436
Polysorbate 80	172.840	E 433
Calcium stearyl lactylate	172.844	E 482
Sodium stearyl lactylate	172.846	E 481
Stearyl lactic acid	172.848	–
Stearyl tartrate	–	E 483
Sodium stearyl fumarate	172.826	–
Sodium lauryl sulfate	172.822	–
Diocetyl sodium sulfosuccinate	172.810	–
Polyglycerol esters	172.854	E 475
Sucrose esters	172.859	E 173
Sucrose glycerides	–	E 474
Lecithin (GRAS)	184.1400	E 322
Hydroxylated lecithin	172.814	F 322
Triethyl citrate (GRAS)	184.1911	–

The specification and assay procedures for all emulsifiers are published in the Food Chemical Codex (Food Chemicals Codex, 2004).

Bakery products are the largest users of food emulsifiers (Stauffer, 1996a). Yeast raised and chemically leavened products are the most important segments. Food emulsifiers are also included in cookies, crackers, pasta, and snacks. Recent figures indicate about 400,000,000–500,000,000 pounds of emulsifiers are used in the U.S. food industry with a market value of about \$500 million. The baking industry accounts for about 50% of the total food emulsifiers market (Brandt, 1996). Annual growth in the production of food emulsifiers is estimated at about 2.0–3.0%.

9.5 Role of the Shortening

The shortening when mixed into a hydrated dough or batter interrupts the development of the gluten network. Literally, the structure is “shortened” and the baked product is tender. The shortening also contributes to the quality of the finished product by imparting a creamy texture and rich flavor, tenderness, and uniform aeration for moisture retention and size expansion. The oil or fat based ingredients are formulated and processed to a plasticity that allows spreadability and dispersion thoroughly and uniformly in a dough, icing or batter over a wide temperature range. The ability of the fat to disperse in streaks or films helps to lubricate the structure of the dough during mixing. The fat dispersion prevents the starch and protein in the flour from compacting into a dough mass (Stauffer, 1996a).

The characteristics of the fat that are important for shortening formulations include melting point, oxidative stability, solid fat index and plasticity. Plasticity is used to define the characteristics of the shortening that are most important to its functionality (Erickson and Erickson, 1995).

Shortenings are processed to various plasticity ranges (Weiss, 1983; O’Brien, 1995a). Narrow plastic range ingredients have a steep solids profile and melt rapidly. These ingredients are commonly used in cream icing products or as a filler fat for hard cookies where melting near body temperature is required. Wide plastic range shortenings contain 15–30% solids over a broad temperature range and resist breakdown during creaming. Their plastic nature enables them to spread readily and combine thoroughly with the other solids or liquids without breaking or having liquid oil separating from the crystalline fat. Commercial shortenings are prepared by carefully cooling, plasticizing and tempering of correctly formulated blends of melted fats and oils. The plasticizing process is often referred to as “Votation.”

The size of the fat crystals in a plasticized shortening has a major influence on the rheological properties of the shortening. A small crystal size with a large surface area is required to bind the liquid oil in the shortening. Typical crystal sizes are from 5 μm to 9 μm (Chawla and deMan, 1990). Crystal size is controlled by the source of the hard fat used (O’Brien, 1996b). The smaller crystalline form is referred to as β' and the larger form is β . Plastic shortenings in the β' configuration consist of small, uniform, needle-like crystals with a smooth texture. These aerate well and have excellent creaming properties.

Two major sources of β' crystalline fats are often used in formulation of vated shortenings. These are cottonseed and palm oil, often fully hydrogenated to less than 10I.V (iodine value). The use level varies from 8% to 15% of the final shortening formula.

9.6 Role of the Emulsifier

Addition of emulsifiers to the shortening promotes the emulsification of the shortening in the dough or batter. Much of the development of shortenings has concentrated on the addition of the emulsifier or emulsifier system to an all-purpose shortening base although specialty liquid, narrow plastic range, and special purpose emulsified products have been produced (O'Brien, 1995a). Today, because of the focus on trans fatty acid free ingredients, much interest has focused on emulsifier systems that permit the use of nonhydrogenated, trait modified oils as the shortening.

The general benefits of including emulsifiers in shortenings are

1. Increased shelf-life.
2. Improved tenderness and flavor release.
3. Reduced mixing time and mixing tolerance.
4. Improved machinability.
5. Better water absorption.
6. Improved volume.
7. Improved hydration rate of flour and other ingredients.
8. Better texture and symmetry.
9. Reduced egg and shortening usage.

9.6.1 *Monoglycerides and Derivatives in Bakery*

The monoglycerides in their many forms are the most used emulsifier in bakery products. Seldom is an ingredient label found that does not list this type of emulsifier. The preparation of monoglycerides begins with reacting glycerin with edible fats and oils or fatty acids in the presence of a catalyst (Henry, 1995). The important characteristics are melting point and monoglyceride content. Commercially available products vary from 40% to 95% monoglyceride content. Two crystalline forms are generally present: alpha and beta. The alpha form is the most functional in bakery products. The major variables involved in the production of monoglycerides are source of the fat, monoglyceride content, iodine value or degree of unsaturation, and fatty acid composition. Approximately 300 million pounds of monoglycerides are used in the United States in yeast-raised bakery products (Knightly, 1988). An equal amount was believed to be used in cakes, icings, and other applications. Cakes prepared with shortenings containing monoglycerides have improved aeration and sugar holding capacity. Breads possess an improved shelf life due to retarded staling rate. Various techniques have been used to improve monoglycerides through chemical modification or formulation with additional emulsifiers. The monoglycerides

marketed for bakery applications include plastic, hydrated, powdered and distilled monoglycerides.

In addition to their antistaling benefit, monoglycerides in bakery products results in

- Reduction of interfacial tension.
- Improved dispersion of ingredients.
- Increased aeration.
- Greater foam stability.
- Modification of fat crystal (Orthoefer, 2006b).

Several derivatives of monoglycerides are prepared (Fig. 9.1). Two main functional types are generally found in bakery applications: dough strengtheners and alpha tending monoglycerides. The “dough strengtheners” includes succinylated monoglycerides (SMG), ethoxylated monoglycerides (EMG), and diacetyl tartaric acid esters of monoglycerides (DATEM). They are also used as emulsifiers, starch and protein complexing agents, and foam stabilizers. The alpha-tending emulsifiers includes GMS (glycerol monostearate), LacGM (lactylated monoglycerides), AcMG (acetylated monoglycerides), and PGME (propylene glycol monoesters). The alpha-tending emulsifiers, normally used in cake mix production contribute to the emulsification of the shortening in the water phase of the batter as well as incorporating air into the fat phase. The alpha tending monoglycerides are believed to form a film at the oil/water interface resulting in a stable emulsion preventing the liquid oil present in the shortening from interfering with aeration during cake batter mixing.

9.6.2 *Sorbitan Emulsifiers*

Sorbitan monostearate is a commonly used oil soluble, low HLB nonionic emulsifier. Reaction of the sorbitan esters with ethylene oxide results in the formation of the polyoxyethylene sorbitan monostearate or polysorbate emulsifiers (PS60 or polysorbate 60) (Fig. 9.2). Sorbitan esters are excellent emulsifiers for improving aeration, gloss and stability of icings. They generally function as emulsifiers, aerating agents, and lubricants in cakes, toppings, cookies and crackers. Polysorbate 60 is often used as a dough strengthener at about 0.2% of flour weight. Polysorbate 60 is also used in combination with glycerol monostearate and propylene glycol monostearate in fluid cake shortenings.

9.6.3 *Anionic Emulsifiers*

The anionic emulsifiers include SMG, DATEM and other lactic acid derivatives (Fig. 9.3). Sodium stearyl lactylate (SSL) and the calcium form is widely used. Both are employed as dough strengtheners.

SSL may be added as a stabilizer to hydrated monoglycerides preparations. The lactic acid emulsifiers also act as antistaling, aeration aids and starch/protein complexing agents.

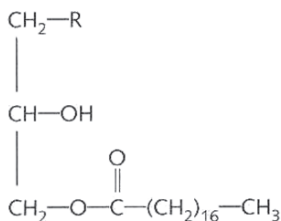

When R equals	Emulsifier
HO—	Glycerol monoesterate (GMS)
—OOCH ₂ CH ₂ COO—	Succinyl monoglyceride (SMG)
$ \begin{array}{c} \text{CH}_3\text{CH—COO—} \\ \\ \text{OH} \end{array} $	Lactylated monoglyceride (LacGM)
CH ₃ —COO—	Acetylated monoglyceride (AcMG)
$ \begin{array}{c} \text{OOCCH} \\ \\ \text{—OOC—CH—CH—COO—} \\ \\ \text{OOCH}_3 \end{array} $	Diacetyl-tartaric acid ester of monoglyceride (DATEM)
H(CH ₂ CH ₂ O) _n O—	Polyoxyethylene monoglyceride or ethoxylated monoglyceride (EMG)
H—	Propylene glycol monoester (PGME)

Fig. 9.1 Monoglycerides and derivatives

9.6.4 Polyhydric Emulsifiers

The main polyhydric emulsifiers are the polyglycerol esters and sucrose esters (Fig. 9.4). Both have multiple applications as emulsifiers for foods and bakery products, particularly the sucrose esters. They provide emulsifying, stabilizing and conditioning properties in baked goods. A maximum of eight hydroxyl groups in sucrose may be esterified. The degree of esterification affects the hydrophilic-lipophilic

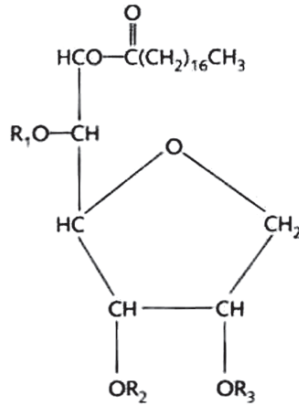

Where

$R_1, R_2, R_3 = H$	Sorbitan monostearate
$R_1 = H(CH_2CH_2O)_n-$	Polyoxyethylene (20) sorbitan monostearate
$R_2 = H$	(Polysorbate 60)
$R_3 = H$	
$R_1 = H(CH_2CH_2O)_n-$	Polyoxyethylene (20) sorbitan tristearate
$R_2 \text{ and } R_3 = H_3C(CH_2)_{16}CO-$	(Polysorbate 65)

Fig. 9.2 Sorbitan esters and derivatives

balance (HLB) of the sucrose ester (Table 9.4). Sucrose esters are used as a non-caloric fat substitute when six or more of the hydroxyls are esterified.

9.6.5 Lecithin

Commercial lecithin is a co-product of soybean oil production. Limited quantities are produced also from corn oil. Lecithin is obtained by water washing of the filtered crude soybean oil. The hydrated lecithin is easily separated from the oil and is vacuum dried. Crude lecithin is a dark colored, viscous mixture composed mainly of a mixture of phospholipids (Table 9.5). Triglycerides, tocopherols, and glycolipids are present. Various purified grades of lecithin are produced by bleaching and fractionation as well as by chemical modification (Schmidt and Orthoefer, 1985). Commercial lecithin products are specified based on the acetone insoluble

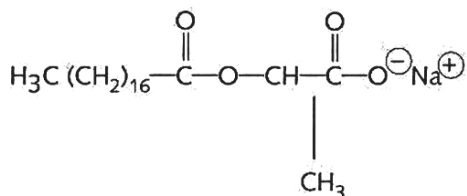

Sodium stearyl lactylate (SSL)
(also in calcium form)

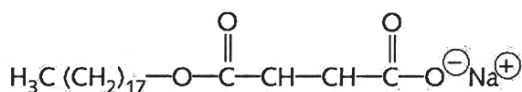

Sodium stearyl fumarate

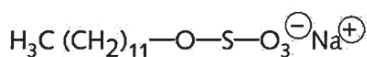

Sodium lauryl sulfate (SDS)

Fig. 9.3 Anionic surfactants

fraction (a measure of the phospholipid content), viscosity and color. Lecithin is also found in egg yolk, butter, beans, and nutmeats. Lecithin is usually an inexpensive emulsifier used for antistick properties as well as emulsification and controlled wetting of dry ingredients.

9.7 Emulsifier Interaction with Bakery Components

Emulsification and lubrication (shortening) by the emulsifier accounts only partially for the beneficial effects observed when they are added to baked products. Proteins and lipids also contribute to the functional properties of the flour. Emulsifiers interact with the various flour components especially the starch, protein and lipids, as well as the added ingredients.

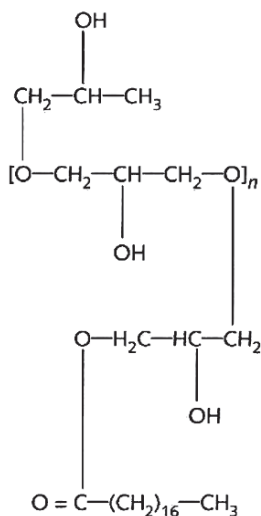

Polyglycerol monostearate

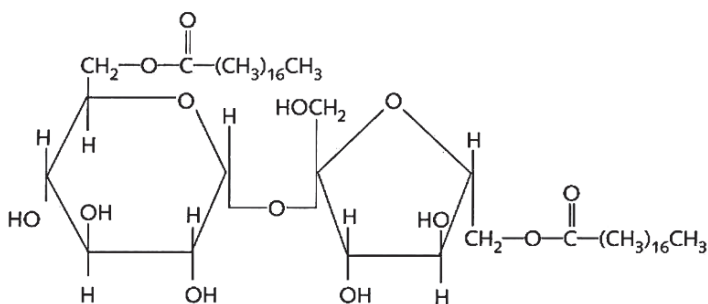

Sucrose diester

Fig. 9.4 Polyglycerol esters and sucrose esters**Table 9.4** Sucrose ester surfactants

Percent monoester	Percent diester	Percent trimer	Percent tetraester	HLB
71	24	5	0	15
61	30	8	1	13
50	36	12	2	11
46	39	13	2	9.5
42	42	14	2	8
33	49	16	2	6

From Stauffer (1996b, p 576)

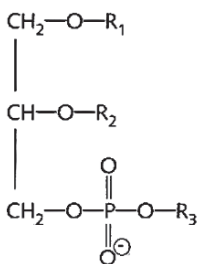
Table 9.5 Lecithin

(R₁ and R₂ are fatty acids)

If R₃ = Choline ethanolamine inositol serine

Then Phosphatidylcholine

Phosphatidylethanolamine

Phosphatidyl inositol

Phosphatidylserine

9.7.1 Starch

Starch exists in a helical, coiled structure with six glucose residues per turn of the helix. This structure is a hollow cylinder with a hydrophilic outer surface and a hydrophobic inner core. The inner space is about 45 nm in diameter. Straight-chain alkyl molecules such as palmitic or stearic acid will fit in the inner space. The n-alkyl portion of emulsifiers such as present in GMS form a complex with the helical regions of the starch. It is this complex that retards starch crystallization, often called “retrogradation,” slowing the staling process.

Emulsifiers affect the cooking and swelling properties of starch (gelatinization). This may be on the rate of gelatinization, gelatinization temperature, peak viscosity or gel strength. Trials with starch pastes containing monoglycerides showed that maximum complexation occurs with monopalmitin (Legendijk and Pennings, 1970). Longer and shorter chain saturated fatty acid monoglycerides reacted to a lesser extent. Unsaturated fatty acid monoglycerides react to a lesser extent due to the bend in the fatty acid chain at the unsaturated bond (Hahn and Hood, 1987).

Other surfactants also modify the gelatinization of starch. DATEM is generally found to be less interactive than GMS or SSL. GMS raises the swelling temperature and results in increased paste viscosity. SSL also increases paste viscosity (Schuster and Adams, 1984). Overall the interaction between emulsifier and starch takes place at the surface of the starch granule and the starch/surfactant complex stabilizes the granule, retarding water penetration and swelling as the temperature is increased (Lakshminarayan et al., 2006).

During breadmaking, only small amounts of emulsifiers are bound to starch in the sponge stage and during mixing. Binding does not occur until the temperature is increased to near the gelatinization temperature. The formation of the starch complex is principally with the amylose or linear starch fraction. Both the degree of interaction and solubilities of the complexes are dependent upon the type of emulsifier.

9.7.2 Protein

The wheat flour proteins, gliadin and glutenin, form a viscous, colloidal complex known as “gluten” when mixed into a dough. Lipids are involved in the formation of the gluten complex. The properties of gluten are dependent upon the lipids and emulsifiers present. Lipophilic portions of surfactants interact with hydrophobic regions of proteins contributing to unfolding or denaturation of the protein. Generally, surfactants contribute to protein denaturation, enhancing interfacial adsorption and emulsion stabilization. The desired result of the protein interaction with emulsifiers is called dough strengthening.

Most commercial dough strengtheners are anionic surfactants. The association of the lipophilic portion of the emulsifier with the hydrophobic area of the protein incorporates the negative charge into the complex with subsequent aggregation in the dough. The overall effect is aggregation of the gluten protein and an increase in dough strength.

The ionic surfactants induce protein insolubilization resulting in increased viscosity and elasticity of the dough. Nonionic surfactants disrupt the hydrophobic portion of the protein leading to reduced dough viscosity and elasticity and increased protein extractability. A blend of emulsifiers generally show the best dispersability and functionality.

9.7.3 Lipids

Wheat flour contains 1.4–2.0% lipids divided into free (0.8–1.0%) and bound (0.6–1.0%) forms. They may be further divided into nonpolar (50.9%) and polar (49.1%) forms. The bound lipids exist as starch inclusion complexes. The nonstarch lipids, about 85% of the total, participate in the chemical, physical and biochemical processes important for the preparation of baked goods. The nonstarch lipids consist of glycolipids, phospholipids and stearoyl esters. Interaction between nonstarch lipids and emulsifiers is limited.

Non-polar-lipid addition to untreated flour results in deterioration of baking properties (Schuster and Adams, 1984). Addition of polar lipids to untreated flour increases loaf volume in breadmaking. The improvement is likely based on the effect of galactolipids and phospholipids. Emulsifiers may interact with the water phase of the dough, forming associated lipid-water structures with free polar flour lipids (Krog, 1981). Emulsifiers may compete with the naturally occurring lipids in

wheat flour for the reactive groups of the wheat flour dough. Their effect on protein components was reduced as well.

9.8 Applications in Baked Goods

9.8.1 Yeast-Raised Products

The function of emulsifiers in yeast-raised products includes dough conditioning, strengthening and crumb-softening. The direct and indirect action of the emulsifier begins with dough preparation and ends with oven baking and storage (Fig. 9.5). The first stage begins with wetting and dispersing activity then follows with interactions with flour components during mixing and in the baking process itself.

9.8.1.1 Dough Conditioning

Dough conditioning refers to the development of less tacky, more extensible doughs. They may be processed through machinery without tearing or sticking. These doughs result in a product of finer crumb structure, improved volume and symmetry. These characteristics include

1. Increased mixing and machining tolerance of the dough.
2. Increased tolerance to variations in ingredients.
3. Diminished knockdown during handling.
4. Assist in maximum dough absorption.

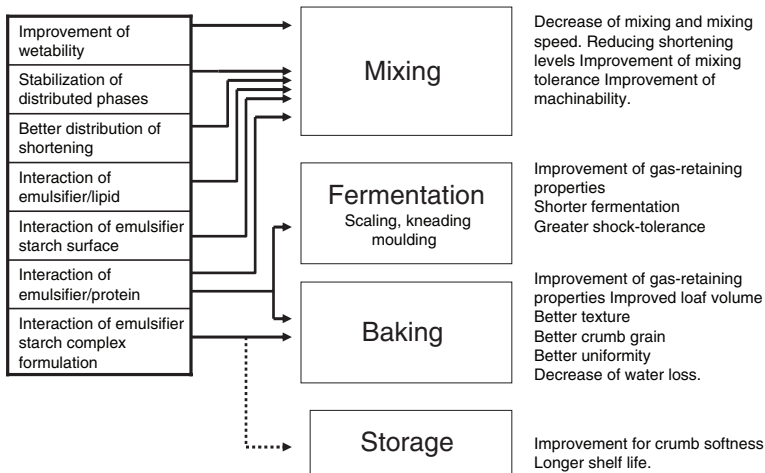

Fig. 9.5 Influence of emulsifiers on production and quality of baked products (From Schuster and Adams, 1984)

5. Reduced shortening requirements.
6. Improved loaf volume, structure, texture, and other quality attributes.
7. Extended keeping quality.
8. Facilitates variety bread production.

In the production of yeast-raised products, the mixing of the dough results in gluten–gluten bonding through disulfide linkages. Development of the linkage is often incomplete resulting in weak dough structure. The gas produced by the yeast escapes through the weak portion of the gluten films. Gas cells having weak gluten cell walls have a tendency to collapse.

Dough strengthening emulsifiers increase the degree of gluten–gluten binding sites and/or bridges that supplement disulfide linkages. This results in stronger gluten films. The benefits from the dough conditioners are

- Improved tolerance to variation in flour quality.
- Drier doughs with greater resistance to abuse.
- Improved gas retention giving lower yeast requirement, shorter proof times, and greater finished product volumes.
- Uniform internal grain, stronger side walls, and reduction of “cripples.”
- Reduced shortening requirements without loss of volume, tenderness, or slicing ease.

The highly functional dough strengtheners are calcium stearoyl lactylate, ethoxylated monoglycerides (EOM), polyoxyethylene sorbitan monostearate (PS60), succinylated monoglycerides (SMG), and sodium stearoyl lactylate (SSL) (Tenney, 1978). Comparative loaf volumes found for the various conditioners are shown in Fig. 9.6 for fully proofed dough shocked to mimic abuse in production.

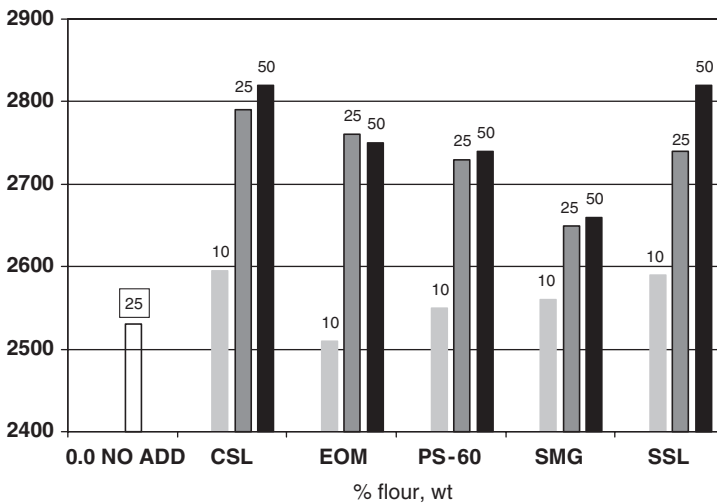

Fig. 9.6 Comparative loaf-volume response produced on abused dough by CSL, EOM, PS-60, SMG, and SSL (From Tenney, 1978)

9.8.1.2 Crumb Softening

Emulsifiers that complex with starch are referred to as “crumb softeners.” The mechanism of activity is the result of an amylose complex being formed. The staling of bread is also believed to result from amylose crystallization. During bread preparation and baking, amylose polymers associate upon cooling forming a rigid gel after 10–12 h. After baking, amylopectin, the branched chain starch fraction, crystallizes more slowly resulting in firming of the bread in 3–6 days. When crumb softeners are added, less free amylose occurs and therefore less is available to form a rigid gel. The emulsifier softens the initial crumb. No change occurs with the amylopectin fraction. It gradually crystallizes to a firmer texture whether or not treated with crumb softeners.

Comparison of crumb softeners as a function of compressibility after 96 h of storage is shown in Fig. 9.7. The most effective softeners are the lactylates and SMG. Plastic mono- and diglycerides and hydrated distilled monoglycerides are also effective. The polysorbate, EOM and lecithin had little starch complexing activity. The lactylates and SMG act as both conditioners and crumb softeners.

The use level of crumb softeners vary. The most commonly use crumb softeners are the water emulsions, or hydrates, of mono-diglycerides. The hydrates contain 22–25% solids and are used from 0.5% to 1% flour weight. The hydrates are

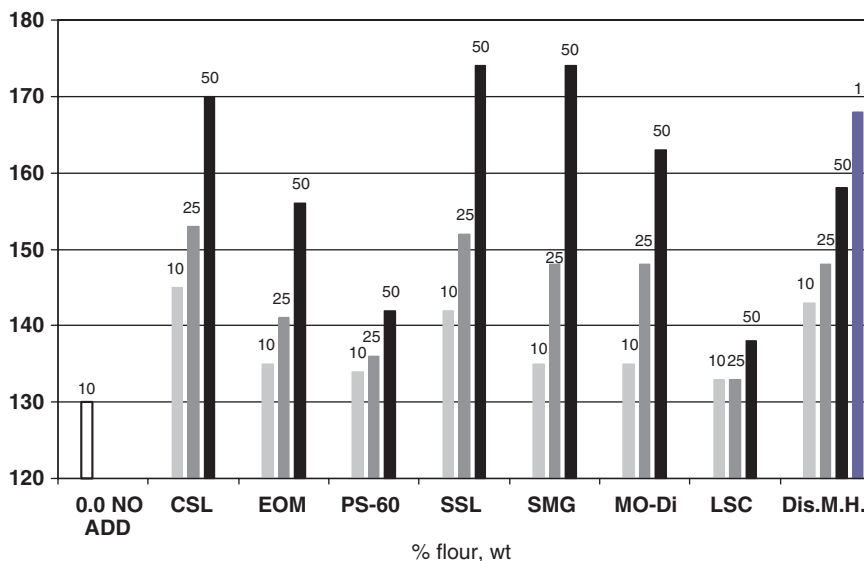

Fig. 9.7 Relative crumb-softening effect in bread by CSL, EOM, PS-60, SSL, SMG, Mo-Di (54% mono- and diglyceride), LEC (lecithin), and Dis. M.H. (22% solids distilled monoglyceride hydrate) (From Tenney, 1978)

significantly more functional than the nonhydrated forms. Water dispersible blends of distilled monoglycerides are also utilized. These blends contain unsaturated monoglycerides to promote rapid hydration in the sponge, brew or dough stage.

9.8.1.3 Emulsifier Blends

Lecithin has been used in breads and baked goods longer than any other emulsifier. Lecithin gives higher ductility through interaction with the gluten. Other activity claimed for lecithin is delayed staling and reduction of shortening. A synergistic effect also occurs between lecithin and monoglycerides. The monoglyceride–lecithin blends produce a better crumb grain, softer bread and higher loaf volumes. Ethoxylated monoglycerides combined with monoglycerides is also an effective dough conditioner. The negative effects of liquid oils in place of “solid” shortenings in bread production are overcome with this combination.

DATM also acts as a dough conditioner, spares shortening and is an antistaling agent in combination with glycerol monostearate. Others include SMG, sucrose esters, polysorbate 60, SSL, and CSL. The SSL and CSL can form complexes with gluten acting as a dough strengthener.

9.8.2 Chemically Leavened Products

9.8.2.1 Cakes

The role of the emulsifier in layer cakes or snack cakes is diverse and includes aeration, emulsification and crumb softening. The aerated structure of batters depend on whipped-in-air and gas (CO_2) from the leavening agent. The emulsifier lowers the surface tension of the aqueous phase improving the amount of air that can be whipped into the batter. Large amounts of finely divided air cells are important for development of uniform grain (Handlemann et al., 1961). The dissolved CO_2 evolves at air cell sites and does not spontaneously form bubbles. If the original batter contains many small air cells, the final cake will have a larger volume and fine (close) grain. The creaming of the sugar and shortening has a major influence on air incorporation. The incorporation of monoglycerides in the plastic shortening (3–5% alpha-monoglycerides) ensures numerous small air cells being created during beating or creaming.

Cake batter is an aerated emulsion. The integrity of the air cells determines cake volume and uniformity. Shortening is antifoam that disrupts foam cells. Emulsifiers, however, coat the exterior of the fat particles protecting the integrity of the air cell (Wooten et al., 1967). Use of appropriate emulsifiers has permitted the use of liquid oils where only solid shortening could previously be used.

Light, tender, moist cakes are preferred by the consumer. Emulsifiers provide the desired aeration, emulsification and crumb softening. Crumb softening

in cakes is a function of moisture retention, shortening activity, and starch complexing. It is the same as for breads. The emulsifier complex with the starch softens the product.

Several types of emulsifiers are used in cakes. Propylene glycol monoester (PGME) is used at 10–15% of the shortening. Monoglycerides and mixtures of lactated monoglycerides with PGME are also used in cake mixes.

In baker's cakes, emulsifier selection depends on formula, production equipment, and labeling requirements. Using soybean oil as the shortening, a hydrated blend of emulsifiers such as PS 60, SSL, sorbitan monostearate, and distilled monoglycerides works well. Fluid shortenings are produced containing lactated monoglycerides. The traditional baker's cake system is a plastic shortening with 5–10% monoglycerides (4% alpha-monoglyceride content). Packaged cake mixes often use emulsified PGME at 10–15% of the oil. The cakes are unusually tender and are not suited to commercial cake production.

Emulsified cake shortenings are also used for cake donuts. The amount of air entrapped during creaming determines the grain in the final donut.

9.8.2.2 Cookies and Crackers

Emulsifier use in cookies and crackers is limited. They do play a role in controlling spread, improve cutting and appearance, and improve texture.

Certain emulsifiers control spread of the cookie dough during baking (Table 9.6). This likely occurs because of modification of the viscosity of the dough. Cookie dough with SSL shows increased spread compared to a nonemulsified control (Rusch, 1981). The SSL may interact with the starch granule delaying hydration of the granule and subsequent gelatinization (Tsen et al., 1973).

Lecithin may be used to produce a drier dough that machines better and releases easier from a rotary die surface. Use is from 0.25% to 0.7% of the flour. Part of the effect may simply be reduction of available water because of lecithin hydration.

Table 9.6 Spread ratios of cookie doughs with different emulsifiers

0.5% additive	Spread ratio
Monoglyceride	8.3
Ethoxylated monoglyceride	8.8
Sodium stearoyl fumarate	10.4
Sodium stearoyl lactylate	10.0
Sucrose monopalmitate	9.8
Sucrose mono- and distearate	9.6
Sucrose distearate	9.7
Sorbitan monostearate	9.2
Polysorbate 60	9.3
Succinylated monoglycerides	9.2

From Tsen et al. (1973)

Lecithin that is highly fluidized with other oils or fatty acids is widely used as a release agent in cookie baking for release from rotary dies. Heat-resistant lecithins such as those modified with acetic anhydride are especially adaptable to this application. Lecithin is used in cookie and cracker formulations at 0.25–1.0% of flour weight. It may be added with the shortening at the creaming stage or simply combined with the shortening when voted.

Antistaling is of less significance in cookies and crackers since they are of lower moisture content. The greasiness of high shortening levels is reduced by the addition of small amounts of lecithin. Lecithin in general produces a “drier” dough with equivalent moisture and shortening levels. The drier dough is more machinable. Other benefits attributed to lecithin are reduced mixing times and dough development with more tender cookies.

SSL is also promoted for cookies and cracker improvement. When incorporated into the dough at 0.25%, flour basis, the SSL produces a finer grained, more uniform pattern of surface cracks. The resistance to shear (firmness) decreases, improving eating quality and permits reduction in shortening (Tenney, 1978). Levels are 0.25% SSL in cookies and 0.1% in crackers based on flour weight.

9.8.3 Extruded Snacks/Cereals

Extrusion cooked snacks, pasta, and cereals often include emulsifiers in their formulas. Gelatinization of the starch occurs during the cooking/extrusion step. Monoglycerides and SSL have been found to reduce the energy required for the extrusion and to produce a desirable texture in the final product. Monoglycerides are added to improve the appearance and smoothness of the extrudate and produce a finer pore structure. Use levels are 0.25–0.5% of the starch weight and is added at the dough make up stage.

9.8.4 Cream Icings

Cream icings are prepared by creaming sugar with fat, then adding flavor, egg white and perhaps a small amount of water. The emulsified shortenings used contain 2–3% alpha-monoglyceride. PS60 at 0.5% is included in some icings to assist in aeration. PGME when incorporated into the shortening produces icings with excellent gloss and gloss retention.

9.8.5 Fat-Free Bakery Products

Fat free and low fat foods are marketed in almost every segment of the food industry. In most instances, there is no single solution for removal of fats from the formulation.

Skillful formulation using fat replacers, emulsifiers, bulking agents, flavors, and other ingredients have been applied to fat replacement.

Low fat and fat free cakes have been produced using additional emulsifiers in conjunction with starch based replace and gums or hydrocolloids for moisture retention and functionality. PGME and DATEM have proved to be particularly useful.

Emulsifiers are not generally regarded as fat substitutes or replacers. Emulsifiers affect the texture and mouthfeel by their surface activity. The caloric value of emulsifiers vary depending on their composition and digestibility. They tend to have fat-like properties through their hydration, water binding, and dispersing effects in processed foods. The general function of emulsifiers in low-fat and no-fat applications are

- Prevent separation of components.
- Reduce size of fat globules and improve dispersion of remaining fat.
- Provide fat sparing action.
- Provide texture perception of higher fat contents.
- Texturize and provide lubricity.
- Complex with starches and proteins.

Mono and diglycerides are the most used emulsifiers. Distilled monoglycerides have lower calories compared to the lower mono content preparations. Other emulsifiers in reduced fat products include the polysorbates, DATEM, polyglycerol esters, and sorbitan esters. Emulsifiers used in products having sucrose esters and mixed esters of short and long chain tri-esters are replacers is very likely similar to that utilizing traditional caloric versions.

9.8.6 Release Agents

A separate application of emulsifiers in bakery products, although not incorporated in the dough, is release agents or pan sprays. Lecithin is the primary emulsifier used. Often the pan sprays are formulated with an oil in combination with mold inhibitors and lecithin. 1–6% lecithin is added. Modified lecithins that possess improved heat stability may be used. The pan spray may simply be brushed on or sprayed to achieve a thin film promoting easy release of baked products from pans or belts.

9.8.7 Trans-Free Shortening

Consumption of trans fatty acids has negative health consequences. As much as 40% of the trans fatty acids in the diet are from shortenings used in bakery product (Orthoefer, 2006b). These originate from the partial hydrogenation process used to produce the shortening. Partial hydrogenation results in oxidatively stable products with the desired properties of shortenings. Alternatives to partially hydrogenated

shortening include simple blending of commodity oils with fully hydrogenated hardfats, interesterified products, use of naturally saturated oils such as palm oil and fractions, and trait modified oils (Cowan and Husum, 2004). For those applications using trans-free shortening, the traditional emulsifiers such as GMS function similarly. Shelf stability of the finished products, particularly with the trait modified oils, seems to not be affected (Orthoefer, 2006a).

9.9 Summary

The market for emulsifiers for bakery products continues to increase. As with many industries, bakeries have undergone consolidation. Fewer producers have placed greater requirements on the final products such as longer distribution, longer time from production to consumption, greater stability and shelf-life. The function of the emulsifier is of ever greater importance. Growth in food service increases the need for bakery products having desirable sensory and performance characteristics to meet the demands of tomorrow's market place.

References

- Brandt, L. (1996). "Emulsifiers in Baked Goods." *Food Product Design* pp 64–76.
- Chawla, P. and L.F. deMan (1990). *J. Am. Oil Chem. Soc.* 67, 329.
- Cowan, D. and T.L. Husum (2004). "Enzymatic Interesterification: Process Advantage and Product Benefits." *INFORM* 15 (3), 150–157.
- Erickson, D.R. and M.D. Erickson (1995). "Hydrogenation and Basestock Formulation Procedures." In *Practical Handbook of Soybean Processing and Utilization*. D.R. Erickson, Ed. pp. 235–237. AOCS Press, Urbana, IL.
- Food Chemicals Codex (2004). *Food Chemicals Codex*, Effective Jan. 1, 2004, National Academic Press, Washington.
- Hahn, D.E. and L.F. Hood (1987). "Factors Affecting Corn Starch Lipid Complexing." *Cereal Chem.* 64, 81–85.
- Handlemann, A.R. et al. (1961). "Bubble Mechanisms in Thick Foams and Their Effects on Cake Quality." *Cereal Chem.* 38, 294.
- Hartnett, D.J. (1977). *J. Am. Oil Chem. Soc.* 54, 557.
- Henry, C. (1995). "Monoglycerides: The Universal Emulsifier." *Cer. Foods World* 40 (10), 734–738.
- Knightly, W.H. (1988). *Cer. Foods World* 33, 405–412.
- Krog, N. (1981). "Theoretical Aspects of Surfactants in Relation to their Use in Breadmaking." *Cereal Chem.* 58, 158–164.
- Legendijk, J. and H.J. Pennings (1970). *Cer. Sci. Today* 15, 354–356, 365.
- Lakshminarayan, S.M. et al. (2006). "Effect of Maltodextrin and Emulsifiers on the Viscosity of Cake Batter and on the quality of Cakes." *J. Sci. Food Agric.* 86 (5), 706–712.
- O'Brien, R.D. (1995a). "Soybean Oil Products Utilization: Shortenings." In *Practical Handbook of Soybean Processing and Utilization*. D.R. Erickson, Ed. pp. 363–379. AOCS Press, Urbana, IL.
- O'Brien, R.D. (1996). "Shortening Types and Formulations." In *Bailey's Industrial Oil and Fat Products*. V.H. Hui, Ed. Vol. 3, pp. 161–193. Wiley, N.Y.

- O'Brien, R.D. (2000). Shortening Technology, in R. D. O'Brien, et al., Introduction to Facts and Oils Technology, 2nd ed., AOCS Press, Champaign, pp. 421–51.
- O'Brien, R.D. (2003). Fats and Oils: "Formulating and Processing for Applications", 2nd Ed. CRC Press, Boca Raton, pp. 325–469.
- Orthoefer, F.T. (2006a). "Trans-Fat Free Shortenings in Baking." Presented at Am. Oil Chemists' Society annual meeting, St. Louis, Missouri. April 30–May 3.
- Orthoefer, F. T. (2006b). "Trans Free Shortenings" Presented at Institute of Food Technologists' annual meeting, Orlando, Florida. June 24–28.
- Rusch, D.T. (1981). "Emulsifiers: Uses in Cereal and Bakery Foods." *Cer. Foods World* 26 (3), 111–115.
- Schmidt, J.C. and F.T. Orthoefer (1985). "Modified Lecithins." In *Lecithins*. B.F. Szuhaj and G.R. List, Eds. Ch. 10, pp. 203–213. AOCS, Champaign, IL.
- Schuster, G. and W.F. Adams (1984). "Emulsifiers as Additives in Bread and Fine Baked Products." In *Advances in Cereal Science and Technology*. Y. Pomeranz, Ed. Ch.4, pp. 139–242. AACC, St. Paul, MN.
- Stauffer, C.E. (1996) "Emulsifiers for the Food Industry, in Bailey's Industrial Oil and Fat Products" 5th Ed., Y. Hui (ed.) Wiley, New York, Vol. 3, pp. 483–516.
- Stauffer, C.E. (1996a). "Properties of Emulsifiers." In *Fats and Oils*. Amer. Assoc of Cereal Chemists. pp. 29–47. St. Paul, Minnesota.
- Stauffer, C.E. (1996b) "Emulsifiers for the Food Industry." In *Baileys' Industrial Oil and Fat Products*. 5th ed. Vol 3, pp. 483–516. Wiley, N.Y.
- Tenney, R.J. (1978). "Dough Conditioners/Bread Softeners." *Bakers' Digest* 52 (4), 24.
- Tsen, C.C. et al. (1973). "High Protein Cookies: Effect of Soy Fortification and Surfactants." *Bakers' Digest* 47 (4): 34–39.
- Weiss, T.J. (1983). *Food Oils and Their Uses*. Avi. Westport, CT.
- Wooten, J.C. et al. (1967). "The Role of Emulsifiers in the Incorporation of Air into Layer Cake Batter Systems." *Cereal Chem.* 44, 333.

Chapter 10

Emulsifiers in Confectionery

Mark Weyland and Richard Hartel

10.1 Introduction

Emulsifiers are used in both chocolate and sugar confectionery products as functional additives that provide significant advantages during both processing and storage. Emulsifiers serve several different functions in confectionery products. In products containing a dispersed fat phase (caramel, toffee, etc.), emulsifiers help to promote breakdown into small fat globules. Emulsifiers also provide lubrication, in part through dispersion of the fat phase, for ease in processing and ease in consumption. In chewing and bubble gum, emulsifiers act as plasticizers of the gum base and also provide a hydration effect during chewing. In fat-continuous confections, namely chocolate and coatings, emulsifiers provide viscosity control, influence fat crystallization, and, as bloom inhibitors, moderate polymorphic transformations of the lipid phase.

As emulsifying agents, emulsifiers in confections enable oil and water phases to be combined in a stable quasi-homogeneous state for an indefinite length of time. These phases have a natural tendency to repel each other, separating into two distinct phases. For example, oiling out of a toffee during cooking is due to uncontrolled coalescence of the fat phase under agitation. As in most food products, this tendency to separate into phases is undesirable and must be controlled by a suitable blend of processing techniques and carefully selected emulsifying agents. Furthermore, even if the food product is satisfactory at the time of production, it must still withstand the rigors of distribution and storage on the shelf, such that at the point of consumption by the consumer, the product has an acceptable taste, appearance and texture. These qualities are often critically dependant on the type and level of emulsifiers used in the product.

An emulsifier acts as a surfactant in some confections. In these cases, the role of the emulsifier is to modify the behavior of the continuous phase of a food product such as to bring about a specific effect or benefit. The most common example of this in confectionery is the use of an emulsifier like lecithin in chocolate to reduce the viscosity of the product and improve the ease of handling and processability.

Many of the classes of emulsifiers described in this book have also found their way into confectionery products. These include lecithin and modified lecithins

such as YN and phosphated monoglycerides, glycerol monostearate, polyglycerol esters including polyglycerol polyricinoleate (PGPR), sorbitan esters, polysorbates, lactic acid and tartaric acid derivatives of monoglycerides, acetylated monoglycerides, sucrose esters and propylene glycol monoesters. All of these compounds have a common feature that makes them suitable as emulsifying agents; namely they are amphiphilic, possessing both lipophilic and hydrophilic properties. The nature of this property is often expressed as Hydrophilic-Lipophilic Balance or HLB. The HLB number is an indication of the properties of an emulsifier, usually given on a scale of 0 to 20. An emulsifier with a low HLB will tend to be more oil-like and will therefore have a greater affinity for the oil phase of a confectionery product. Lecithin, for example, has an HLB of 4 and has an affinity for the oil phase in chocolate. Polysorbate 60, by contrast, has an HLB of 15 and is quite soluble in water; it therefore has an affinity for the syrup phase in toffees and caramels.

It is often the case in food products, and in confectionery too, that a combination of two emulsifiers in a formulation containing two distinct phases results in a longer lasting and more uniform product. In these cases, combinations of low and high HLB emulsifiers often give the best results.

In this chapter, a number of the more common confectionery categories that use emulsifiers are described, along with a review of the available knowledge relating to the most optimal emulsifier types and their benefits.

10.2 Emulsifiers in Chocolate and Compound Coatings

The use of emulsifiers in chocolate and compound coatings is perhaps the best documented in the literature of any of the applications in confectionery. In chocolate, the primary emulsifiers used are lecithin and PGPR, whereas numerous other emulsifiers may be found in compound coatings. For the most part, emulsifiers provide control over flow properties when used in chocolates and coatings, although they may have other effects as well. The addition of low levels (tenths of a percent) of emulsifiers can reduce viscosity equivalent to several percent addition of more fat (e.g., cocoa butter). In this sense, emulsifiers are cost-saving ingredients in chocolate. However, different emulsifiers have different effects on flow properties and it is important to understand the mechanisms of these effects in order to optimize their use.

Chocolate and compound coatings are dispersions of solid particles in a continuous fat phase. The solid particles are composed of sugar granules, milk solids, and cocoa solids. Both chocolate and compound coatings contain 30–35% fat (the rest is mostly particles), with the difference between chocolate and compound coating being in which fat is present. In chocolate, the fat is cocoa butter and comes directly from the crushing of cocoa nibs, whereas in compound coatings, the fat comes from vegetable oils added to the formula. Chocolates and coatings also contain a small

amount of moisture (about 0.5%), introduced indirectly via the sugar or other solid ingredients. It is the presence of these solid particles and moisture that causes chocolate and compound coatings to deviate from true Newtonian viscosity behavior. When the solid particles flow past each other, there is an attraction of the hydrophilic surfaces towards each other. The resultant internal friction causes the apparent viscosity of the material to vary according to the applied shear rate (non-Newtonian behavior).

Viscosity is a very important consideration in how chocolate and compound coatings are used, because they always have to flow to either fill a mould without defects or air bubbles or cover a candy piece with a thin, even coat. The rheological behavior of the coating is dependant on both the nature of the continuous liquid phase (the fat and fat-soluble ingredients) and the nature of the dispersed particulate phase. The dispersed phase volume (mass of particulates), their size and size distribution, and their shape and surface characteristics all impact the rheological behavior of chocolate and coatings.

Molten chocolate and coatings are non-Newtonian fluids, exhibiting shear-thinning behavior. That is, the apparent viscosity of chocolate decreases as the shear rate increases. Chocolate seems thinner when stirred or pumped at higher rates. By convention, the rheological properties of chocolate are characterized by the Casson model (Seguine, 1988).

$$(\sigma)^{1/2} = (\sigma_0)^{1/2} + (\eta_c)^{1/2} (\dot{\gamma})^{1/2} \quad (10.1)$$

Here, σ shear stress,

σ_0 Casson yield value,

η_c Casson plastic viscosity, and

$\dot{\gamma}$ shear rate.

The rheological properties of chocolates are defined by the Casson parameters, plastic viscosity, η_c , and yield value, σ_0 . “Plastic viscosity” is defined as the force required to keep liquid chocolate flowing once it has started moving, whereas “yield value” is the force required to start the mass of liquid chocolate moving. Plastic viscosity and yield value are often combined in a single value called “apparent viscosity.” However, this simplification results in a loss of detail since chocolates with equal apparent viscosities can have different yield values and different plastic viscosities. Furthermore, independent control over yield value and plastic viscosity are often needed to design chocolates and coatings for specific tasks.

Coatings can always be made more fluid for better control by adding more cocoa butter or vegetable fat to the mix, but as these are the more costly ingredients in coatings, this is often an unattractive solution. Better by far is to add a surfactant like lecithin or PGPR to reduce coating viscosity. Both plastic viscosity and yield value can be decreased by the use of specific surfactants and this enables the chocolate manufacturer to have greater control of cocoa butter or levels.

10.2.1 Lecithin

Lecithin is commercially extracted from either soybean or sunflower seeds by solvent extraction and precipitation. It is a light brown fluid that contains approximately 65% acetone insoluble phosphatides and 35% soybean oil. An average chemical composition of soy lecithin is given in Table 10.1. However, Geisler (1991) lists nearly thirty different components of soy lecithin and generally differentiates the components based on their acetone solubility. The acetone soluble portion contains primarily soybean oil, fatty acids, glucosides and sterols. The acetone-insoluble fraction contains the phospholipids as well as any carbohydrates bound to the phospholipids.

The surface-active components of lecithin are amphiphilic molecules that exhibit both lipophilic and hydrophilic properties. The chemical structure of one of the main components of lecithin (phosphatidyl choline) is shown schematically in Fig. 10.1. The phosphatidyl group, the hydrophilic component of the lecithin molecule, prefers to be in the aqueous phase, whereas the two fatty acid chains are lipophilic and orient into a lipid phase of a food. Depending on the source, the fatty acid chains may be either saturated (palmitic or stearic) or unsaturated (oleic or linoleic). In chocolate and coatings, the hydrophilic part of the lecithin molecule orients at the hydrophilic sugar crystal surface, with the fatty acid chains oriented into the continuous fat phase.

Due to its surface-active nature, particularly at the hydrophilic sugar crystal surface, lecithin provides a significant reduction in viscosity of chocolate and coatings.

Table 10.1 Average (%) composition of Soy lecithin

Soybean oil	35
Phosphatidyl choline	18
Phosphatidyl ethanolamine	15
Phosphatidyl inositol	11
Other phosphatides and polar lipids	9
Carbohydrates, e.g., sterols	12

From Minifie (1980)

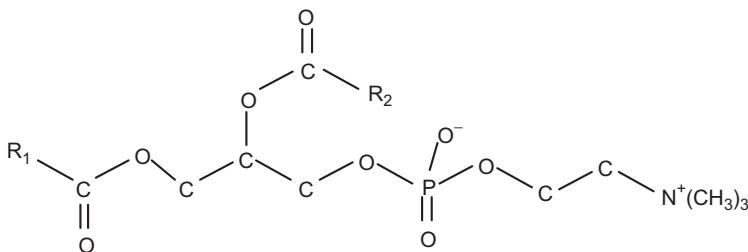

Fig. 10.1 Molecular structure of phosphatidylcholine. R_1 and R_2 are the alkyl chains

For example, addition of 0.5% lecithin to a coating gives the same viscosity reduction effect as addition of 5% cocoa butter or vegetable fat (Minifie, 1980). Lecithin allows coating users to operate efficiently at much lower fat contents than would otherwise be the case (Fig. 10.2).

Lecithin addition up to about 0.6–0.8% results in a decrease in both Casson yield value and plastic viscosity (and thus, the decrease in apparent viscosity). However, higher addition levels actually cause apparent viscosity to increase again. Higher addition levels result in an increase in Casson yield stress with no further reduction in Casson plastic viscosity; thus, the apparent viscosity increases (Chevalley, 1988). According to Chevalley (1988), Casson yield stress begins to increase in chocolate with 33.5% fat content (1.1% water) when lecithin addition level is about 0.5%, whereas in a chocolate with 39.5% fat (and 0.8% water), the increase in Casson yield value began at about 0.4% lecithin addition. Whether this difference is due to fat content or water content is not clear. Lecithin used in excessive amounts may also produce certain negative effects, such as softening of chocolate and increase of crystallization time (Jeffery, 1991). This is because the chemical structure of lecithin is very different from cocoa butter or vegetable fats and it can interfere with the crystallization process in the fat phase.

A potential explanation of the mechanism by which lecithin reduces intra-particle friction was offered by Harris (1968). Moisture present in chocolate and compound coatings adheres to the surface of sugar particles to give them a syrupy, tacky surface that in turn increases friction between the sugar grains. When lecithin is introduced, the hydrophilic functional group in lecithin attaches itself to the sugar surface while the lipophilic group is left to project out into the surrounding oil

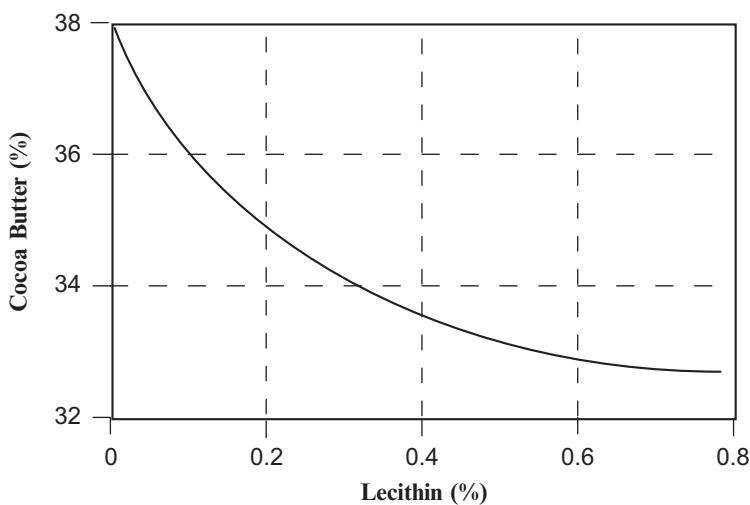

Fig. 10.2 Effect of addition of lecithin on fat content required to maintain constant viscosity in dark enrobing chocolate (after Minifie, 1980)

phase. This enables the particles to slip more easily over each other reducing the viscosity. Rousset et al. (2002) studied the action of lecithin at the sugar crystal interface by inverse gas chromatography. Their results show that adsorption of lecithin at the sugar crystal surface increases the lipophilic character of that surface, which decreases sucrose-sucrose interactions. This effect is demonstrated in Fig. 10.3 where the viscosity reducing effect of lecithin is only seen where sugar is present in the formula. However, the increase in viscosity (yield value) at higher lecithin levels has not been adequately explained. Geisler (1991) suggests that this effect is due to lecithin multilayer formation at the interface.

The viscosity of a dispersion of particles in liquid oil is actually a function of numerous parameters, above and beyond the emulsifier used. The nature of the solid dispersion affects viscosity (Chevalley, 1988), including parameters such as dispersed phase volume, particle size and shape, and surface characteristics. Also, the type of oil used and its level of minor impurities, especially those that are surface-active, can affect flow properties. Babin et al. (2005) studied model systems

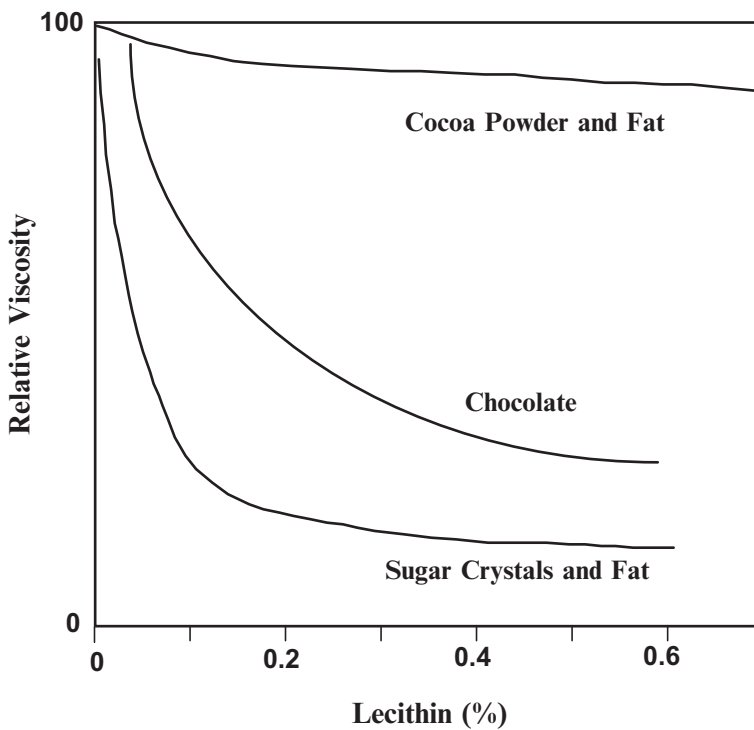

Fig. 10.3 Effects of cocoa particles and sugar crystals on viscosity of suspensions, as compared to the behavior of chocolate (after Minifie, 1980)

of sugar crystals dispersed in different fats. For the same level of dispersed phase solid particles, viscosity was different in different oils (no emulsifier added). Viscosity (and the Casson parameters) in cocoa butter was always the lowest of the fats studied, whereas highest viscosity was found in palm kernel oil. Soybean oil and milk fat had intermediate viscosity. Addition of lecithin always reduced viscosity, but the effects were different in different oils. The greatest effect in decreasing viscosity was found in palm kernel oil. The viscosity results were found to correlate well with differences in sedimentation volumes of sugar particles in each oil. Samples that had highest viscosity also had highest sedimentation volume, indicating that particle attractive forces were strong. Differences in sedimentation volume (and hence viscosity) were also seen when the oils were purified by contact with either activated charcoal or Florisil. In general, lower sediment volume (more compact sediment with fewer aggregated particles) was found after the oils were purified, although some differences were observed among the fats. Sedimentation volumes decreased for both activated charcoal and Florisil treatment of soybean oil, whereas the sedimentation volume for cocoa butter did not change at all after either treatment. For palm kernel oil, sedimentation volume went down after Florisil treatment but did not change after treatment with activated charcoal. Interestingly, the sedimentation volume for milk fat went down after activated charcoal treatment, but increased after treatment with Florisil. Treatment of the oils with either activated charcoal or Florisil will remove certain types of minor impurities, including water and polar lipids. However, no compositional data was provided from which to understand the molecular basis for changes in sedimentation volume (and therefore, of viscosity).

Lecithin is usually added late in the chocolate or compound-making process since it can be absorbed by cocoa particles during grinding and mixing, thereby losing its effectiveness. In some cases, a small amount of lecithin is added to the mixed ingredients prior to roller refining to aid in the grinding process, but the remaining portion is added just before the end of the conching process. This provides the maximum liquification of the chocolate or compound coating at minimum fat content.

Lecithin also has the benefit of protecting coatings against moisture invasion and sugar granulation, which may occur at temperatures above 60 °C when stored in bulk form.

10.2.2 Synthetic Lecithin

Synthetic lecithins are made by reacting mono, di and triglycerides of partially hydrogenated rapeseed oil or other liquid vegetable oil with phosphorous pentoxide to produce phosphatidic acids. Neutralization with ammonia or caustic soda results in an ammonium or sodium salt. These surfactants are often given the name synthetic lecithins or sometimes YN lecithin. They have a neutral flavor, have a slightly greater effect of reducing chocolate viscosity than lecithin extracted from soya, as seen in Fig. 10.4, and can be used at higher dosage levels than natural lecithin without the negative impact on

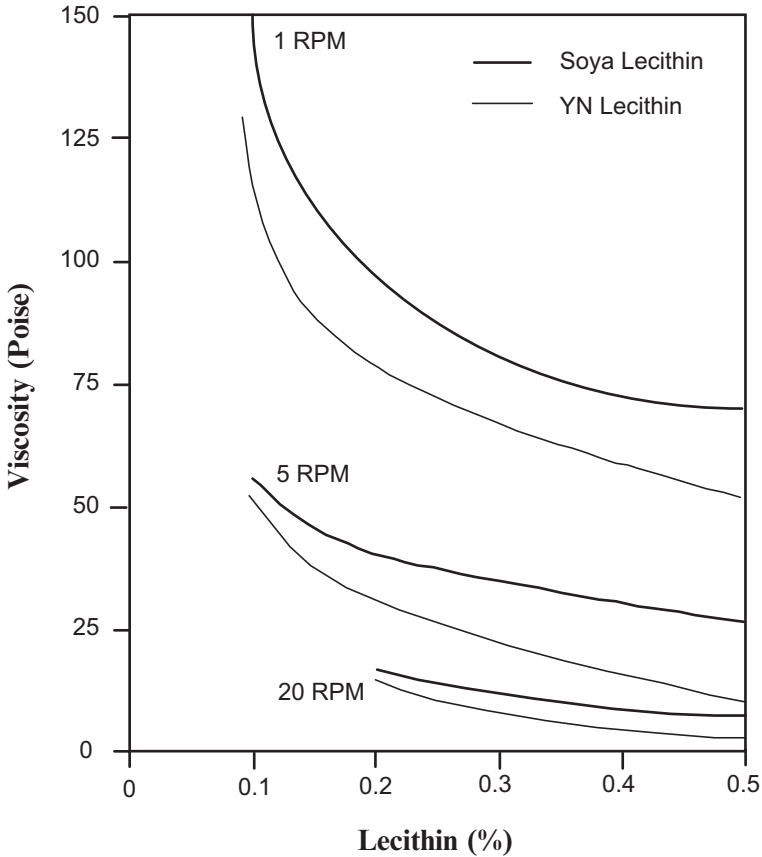

Fig. 10.4 Brookfield viscosity measurements of milk chocolate at three levels of shear (RPM). Comparison of effect of soya lecithin and YN lecithin (after Minifie, 1980)

viscosity (Bonekamp-Nasser, 1992; Kleinert, 1976; Nakanishi, 1971). They are not generally used in the United States because of cost (Geisler, 1991).

YN lecithin is also claimed to reduce the thickening of chocolate and compound coatings due to moisture and overheating (Bradford, 1976). A comparison between lecithin at 0.3%, YN at 0.3%, and cocoa butter added at 5% to chocolate gave similar overall viscosity readings (see Fig. 10.5), but a calculation of the Casson yield values showed that YN produced significantly lower values than with the other systems. The viscosity-reducing effect of YN is reportedly less in milk-free coatings than with milk coatings (Kleinert, 1976; Hogenbirk, 1989). Milk coatings have generally higher viscosities than milk-free coatings due to the effect of milk solids/fat/emulsifier interactions. These interactions result in higher viscosities compared to coatings containing only cocoa solids and sugar for surfactant adsorption. Details of how these interactions occur are absent from the literature.

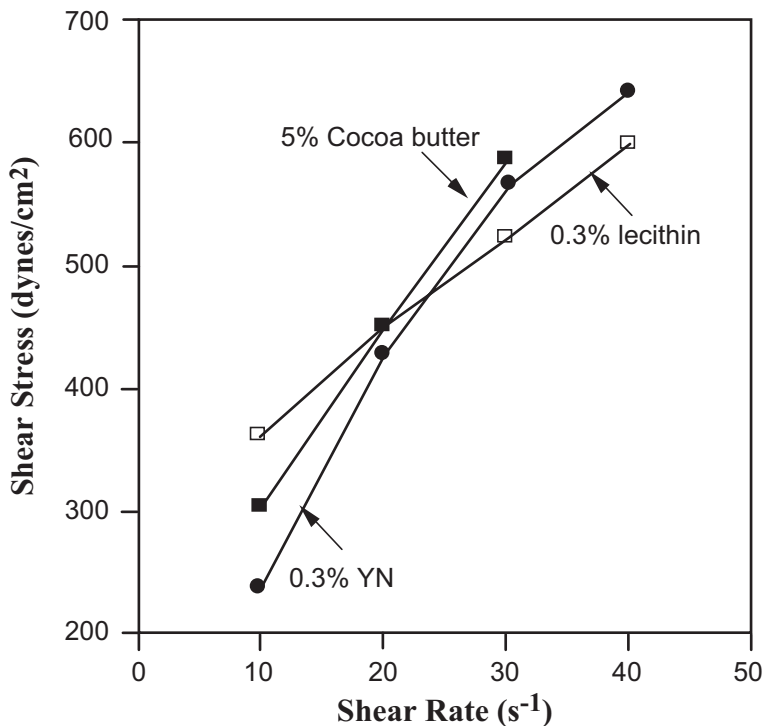

Fig. 10.5 Viscosity plot comparing lecithin, YN and cocoa butter (adapted from Bradford, 1976)

10.2.3 Polyglycerol Polyricinoleate (PGPR)

PGPR is a surfactant used in the chocolate and compound industries in Europe and other parts of the world, and has recently been approved for use in the United States. It has a unique role to play in modifying the viscosity behavior of chocolate coatings. It is made by reacting polyglycerol with castor oil fatty acids under vacuum. The resultant material is a colorless, free-flowing fluid with little or no odor. PGPR is also claimed to be a moisture scavenger in chocolate and compound coatings (Garti and Yano, 2001), preventing thickening of coatings over time (Application Notes Admul WOL, Quest International).

Its chemical structure, in general form, is shown in Fig. 10.6.

A number of studies have been published that compare the effects of PGPR with lecithin and YN. Most conclude that PGPR, when added to chocolate or compound coatings at 0.5% or less, can reduce the coating yield value to almost zero (Application Notes Admul WOL, Quest International; Bradford, 1976). The practical benefit of such a feature is that in a chocolate bar molding operation, PGPR addition would allow the chocolate to flow easily into even complicated mold

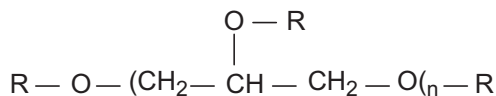

Fig. 10.6 Chemical structure of polyglycerol polyricinoleate (PGPR), where R = H or a fatty acyl group derived from poly condensed ricinoleic acid and n = the degree of polymerization of glycerol

Table 10.2 Casson plastic viscosities and yield values of a milk chocolate when cocoa butter, lecithin and PGPR are added

Addition	Amount	Casson plastic viscosity (poise)	Casson yield value (dynes/cm ²)
Cocoa butter	0.0	45	110
	1.0	29.8	97
	2.0	26.5	62
	4.0	16.3	58
	5.0	15.3	58
Lecithin	0.05	30.0	79
	0.1	26.7	54
	0.2	20.0	40
	0.4	15.6	37
PGPR	0.075	30.0	86
	0.175	29.2	38.5
	0.3	26.8	22
	0.5	30.5	2.5
	0.6	32.0	2.0
Lecithin + PGPR	0.1	14.1	34
	0.2	13.4	32
	0.3	12.7	29

shapes without entrapping air bubbles and also flow around inclusions. Furthermore the opportunity exists to reduce the fat content of the chocolate as well as the cost of chocolate formulations.

A typical comparison of lecithin and PGPR additions to a milk chocolate with 35.5% fat content is shown in Table 10.2, and a similar comparison in dark chocolate is shown in Table 10.3 (Application Notes Admul WOL, Quest International).

In milk chocolate, it is possible to reduce the yield value to almost zero through addition of PGPR. Rector (2000) observed a similar decrease in Casson yield value when using PGPR in chocolates. The combination of lecithin and PGPR also allows the plastic viscosity to be decreased (Table 10.2). In dark or semi-sweet chocolate, the effect of PGPR on plastic viscosity is slight while it can reduce yield values to very low values at 0.5% addition (Table 10.3). Schantz and Rohm (2005) suggest that the most efficient mixtures of lecithin and PGPR for reducing yield stress in both milk and dark chocolates was 30% lecithin and 70% PGPR. Lowest plastic viscosity values were found for 50:50 mixtures of lecithin and PGPR in dark

Table 10.3 Casson plastic viscosities and yield values of a dark chocolate when cocoa butter, lecithin and PGPR are added

Addition	Amount	Casson plastic viscosity (poise)	Casson yield value (dynes/cm ²)
Lecithin	0.3	18.5	155
	0.7	17.1	221
	0.97	14.4	297
	1.3	12.4	285
PGPR	0.0	12.9	199
	0.1	12.5	151
	0.2	14.8	82
	0.5	14.9	13
	1.0	15.9	0

chocolate, whereas the ratio 75:25 lecithin to PGPR gave the lowest plastic viscosity for milk chocolate. They concluded by stating that yield stress and plastic viscosity could be tailored to suit a specific application by proper choice of the lecithin to PGPR ratio.

PGPR is also claimed to be advantageous for use in ice cream coatings since it allows low apparent viscosities in the presence of low levels of moisture (Bamford et al., 1970). Also claimed is PGPR's beneficial effect on fat phase crystallization leading to easier tempering, improved texture and longer shelf life of coatings (Application Notes Admul WOL, Quest International). The viscosity-reducing properties of PGPR lead to significantly reduced viscosity at temper and a level of temper, as measured by a temper meter, which is easier to maintain over long periods in an enrober without significant recirculation of chocolate via melt-out and retempering circuits (personal communication).

PGPR's most recognized benefit remains that of fat reduction, and manufacturers claim that a blend of 0.5% lecithin and 0.2% PGPR allows cocoa butter reductions of approximately 8%.

10.3 Anti-Bloom Agents in Chocolate and Compound Coatings

Fat bloom in chocolate and compound coatings is due to the appearance of fat crystals emanating from the surface (Timms, 2003; Lonchampt and Hartel, 2004). A bloomed chocolate or coating is characterized by an initial loss of surface gloss, followed by appearance of a white or gray haze at the surface. Fat bloom can occur for many reasons, and may be related to improper processing conditions, composition and storage conditions. Numerous references can be found documenting the effects of various emulsifiers on fat bloom in chocolates and compound coatings, although our understanding of the complex phenomena that lead to bloom formation is still incomplete (Lonchampt and Hartel, 2004).

One of the main goals during processing of chocolate is to ensure that the cocoa butter crystallizes in the correct crystal form or polymorph (Timms, 2003). Cocoa butter has several different polymorphic forms that have melting points ranging from 17 to 35 °C. The forms are represented by the Greek letters γ , α , β' and β , listed in increasing order of stability. As the polymorphic form increases in stability, it also increases in melting point. To make chocolate in the familiar glossy, fast-melting form with good snap, it is necessary to crystallize the cocoa butter in a high-melting, reasonably stable polymorph, sometimes called the β V form. This form of cocoa butter is also needed to ensure good contraction in molded products and the long bloom-free shelf life expected for good quality chocolate goods. However, the β V form is not the most stable polymorph for cocoa butter, and it slowly converts to the most stable β VI form.

Fat bloom can be caused by a number of different mechanisms.

1. If chocolate is not preconditioned (tempered) correctly such that insufficient concentration of seeds in the β form is present in the crystallizing chocolate mass, this leads to a higher level of less stable β' forms in the chocolate mass, which later transform to the more stable β form. This transformation causes the chocolate coating or bar to contract and squeeze liquid fat to the surface. Chocolate contains liquid fat even at room temperature, where cocoa butter attains a maximum solid fat content of approximately 85%. This liquid fat at the surface crystallizes in an uncontrolled fashion and is a mixture of β , β' and even possibly some α forms.
2. When chocolate is tempered correctly, but subjected to wide temperature variations in storage and distribution, partial melting and re-solidification of the chocolate occurs, leading to bloom formation. Under these conditions, uncontrolled recrystallization takes place and extensive bloom can occur. This kind of change is often referred to as heat damage and the product is classified as not heat resistant.
3. In molded bars that contain peanuts or other nutmeats as solid inclusions, or in enrobed products that have centers containing quantities of soft vegetable oil or dairy butter oil, this oil can “migrate” from the center to the chocolate shell. The soft oil will cause the chocolate to become soft as the cocoa butter dissolves in the oil. This will cause severe damage to the product due to physical handling prior to consumption or due to discoloration and bloom of the chocolate shell, which will now be far more heat sensitive.
4. Long-term changes in cocoa butter crystal structure via β V to β VI transitions can also be a cause of bloom in some cases.

In all the cases above, the negative impact of uncontrolled crystallization is discoloration and fat bloom. This phenomenon is also seen in compound coatings based on other vegetable fats, although there is some question whether the same mechanisms apply (Lonchampt and Hartel, 2004). Since many compound coating fats (e.g., palm kernel oil) have long-term stability in the β' polymorph, yet still undergo bloom formation during storage, it has been postulated that different mechanisms are responsible for bloom formation in coatings. However, palm kernel oil actually

transforms to a β form over long times (Timms, 2003), and the presence of a β polymorph has been associated with bloom in compound coatings (Talbot et al., 2005).

Emulsifiers also help control the rate of crystallization of cocoa butter and other vegetable hard butters, both at time of production and during subsequent storage and distribution. Since the nature of the lipid crystalline microstructure undoubtedly has an effect on factors such as liquid oil migration, controlling rate of crystallization may be an important mechanism of emulsifier action in inhibiting bloom. Another potential mechanism by which emulsifiers may help inhibit bloom is through retardation of polymorphic transitions (Garti, 1988; Garti and Yano, 2001).

10.3.1 Sorbitan Tristearate (STS)

STS is an emulsifier often associated with bloom prevention; it is claimed that when added to chocolate in the liquid state at 2% it slows down the crystallization rate of cocoa butter, thereby reducing the concentration of the most unstable α form. The more stable β' form is still produced, but this transforms into the β form thus deterring bloom (Anon, 1991a). In this way, STS behaves as a crystal modifier.

However, STS has also been shown to have an effect on the polymorphic transition from β V to β VI. Garti et al. (1986) showed that STS is particularly effective at blocking this V to VI transformation and, hence, preventing bloom even after extensive temperature cycling between 20 and 30°C. Garti et al. (1986) also studied the effects of Sorbitan Monostearate and Polysorbate 60 on cocoa butter polymorphism, but these were only half as effective as STS on preventing bloom. STS is a high melting point emulsifier (~55 °C) whose structure is more closely related to cocoa butter triglycerides than most other emulsifier types. It is speculated that it is due to this similarity that it cocrystallizes with cocoa butter from the melt and due to its rigid structure, binds the lattice in the β V form. Other more liquid or less triglyceride-like emulsifiers tend to depress the melt point of crystallized cocoa butter, increasing liquidity and promoting form IV to V transformations in preference.

Cocrystallization of STS with cocoa butter is presumably why STS is a more effective anti-bloom agent in solid chocolate than in enrobed chocolate items, where soft center oils often migrate into the chocolate, dissolve cocoa butter crystals and allow a β' to β transition. Krog (1977), however, claims that STS locks fats in the less stable β' form and prevents the transformation to β . Berger (1990) also claims that STS performs well as a bloom inhibitor or gloss enhancer in palm kernel oil based compound coatings used to enrobe cakes by stabilizing the β' form of the vegetable fat, a situation also observed by the author in several practical cases using lauric coating fats but with much less reliability when using domestic fats such as soybean or cottonseed based coating fats. Such products tend to have longer bloom-free shelf lives in many cases so that the need for anti-bloom additives is not so imperative.

STS is not allowed in chocolate in the United States, but is often found in compound coatings for the benefits it can bring to appearance and stability. STS is more widely accepted as an additive in EC countries.

10.3.2 *Sorbitan Monostearate (SMS) and Polysorbate 60*

SMS and polysorbate 60 (also known as polyoxyethylene (20) sorbitan monostearate) are also used as anti-bloom agents, especially in compound coatings. They are not as effective as STS but have the advantage of being already accepted by FDA as food grade emulsifiers. They are usually used in combination, where the SMS acts as a crystal modifier and the polysorbate acts as a hydrophilic agent to improve emulsification with saliva and aid flavor release (Dziezak, 1988; Lees, 1975). SMS, with a melt point of 54 °C, can also be used at high levels in coatings to increase heat resistance; unfortunately, the addition of SMS and the high melting point also cause the coating to become waxy.

Up to 1% of SMS and polysorbate 60 can be added to coatings to improve initial gloss and bloom resistance. The optimum ratio of SMS to polysorbate 60 has been given as 60:40 (Woods, 1976). These emulsifiers are claimed to function by forming monomolecular layers of emulsifier on the surface of sugar and cocoa particles, thereby inhibiting the capillary action that causes liquid fat to migrate to the surface and cause bloom. Lecithin is still needed in these systems to control coating viscosity and reduce fat content.

SMS (or Span 60) and polysorbate 60 (or Tween 60) are also generally thought to reduce the rate of fat crystallization; therefore, to develop proper crystal size a suitable tempering system needs to be employed. SMS and polysorbate 60 may be employed in both chocolate and compound coatings with advantage if fast crystallization of the coating would be disadvantageous.

10.4 Other Emulsifiers Used in Coatings

Mono- and diglycerides are also used as additives to chocolate and compound coatings, often as their purified or distilled forms. They can act as seeding agents especially when in high melting point forms such as glycerol monostearate (GMS). They are more commonly used as anti-bloom agents in lauric-type palm kernel oil compound coatings to extend useful shelf life. A typical usage level would be 0.5%. Berger (1990) claims good results in hydrogenated palm kernel oil coatings when using glyceryl lacto palmitate at 1–5% as a gloss improver; the application was as a coating for a baked product. Moran (1969) found that a polyglycerol ester of stearic acid reduced the viscosity of fat-sugar systems more effectively than lecithin as well as retarded crystallization, improved gloss and gave better demolding.

Lactic acid esters of monoglycerides have also been used to control gloss in compound coatings (Hogenbirk, 1989; Dziezak, 1988) and to improve demolding performance (Anon, 1991b). Woods (1976) describes the use of triglycerol monooleate in compound coatings and chocolate to improve initial gloss and gloss retention, and triglycerol monostearate as a whipping agent to aerate coatings giving them a lighter

texture for filling applications. Herzing et al. (1982) describes in detail the types of polyglycerol esters, triglycerol monostearate, octaglycerol monostearate and octaglycerol monooleate, needed to optimize the glossy properties of lauric and nonlauric compound coatings. These emulsifiers are added to the coating fat at up to 6% by weight.

Polyglycerol esters have also been claimed to speed up the setting time of chocolate pan coatings when used at levels of 0.4–0.6% (Player, 1986). Hogenbirk (1989) found some degree of viscosity reduction in compound coatings made with mono- and diglycerides, diacetyl tartaric esters of monoglycerides (DATEM), acetylated monoglycerides, and propylene glycol monoesters. Musser (1980) showed the benefits of adding up to 1.5% DATEM to chocolate and compound coatings to modify viscosity and to improve the rate of fat crystallization. The addition of DATEM to fully lecithinated milk and dark chocolates, and dark sweet coatings, caused a further decrease in viscosity, an effect also observed by Weyland (1994). DATEM also acted as a seeding agent, improved the speed of crystallization and resulted in finer grain and better gloss in molded bars.

10.5 Emulsifiers in Non-Chocolate Confectionery

Unlike in chocolate and compound coatings, the continuous phase of sugar confectionery is not lipid, but sugar syrup (in this case, “sugar” means any nutritive carbohydrate sweetener). For this reason, the role of an emulsifier in sugar confectionery is to enable small quantities of lipophilic material to be finely dispersed within a sugar matrix to achieve a desired effect. This effect may involve the dispersion of fat globules, hydrophobic colors and flavors, or some other fat-soluble ingredient throughout the sugar matrix, or the direct physical interaction of the emulsifier with the sugar phase to achieve the desired textural properties.

A major factor in consumer acceptance of a confection is the “mouthfeel.” Vegetable fats and emulsifiers are used to improve texture and lubricate the product to achieve better chewing characteristics. For example, a small amount (a few percent) of fat in a chewy candy provides lubrication both during processing (with high-speed equipment) and consumption (with teeth). A well-chosen surface-active agent can improve this aspect as well as slow down the release of added flavorings. They will affect the viscosity characteristics of the sweet and may even influence the crystal shape present in grained confections. Furthermore, improvement in fat dispersion throughout the confection slows the rate at which the ingredient becomes rancid as the amount presented or migrating to the surface is lessened.

Emulsifiers are commonly found in confectionery products like chewing and bubble gum, caramel, toffee and fudge, starch-based candies like jellies and licorice, and chewy candies.

10.6 Chewing Gum

Gum is made of gum base, sweeteners, humectants, and colors, flavors and acids. Gum base, the main functional ingredient of gum, contains numerous components chosen to provide the specific attributes (chewing versus bubble gum, acid or non-acid gum, flavor release, hardness, etc.) desired in gum. Although the composition of gum base is controlled by the Code of Federal Regulations, a wide range of ingredients can be added to provide specific functionality. The primary functional ingredient of gum base is the elastomer, either synthetic or natural, which provides the desired chewy characteristic. However, various modifiers, fillers, plasticizers, softeners, emulsifiers and antioxidants can be added to gum base to provide specific effects and are not required to appear on the product label.

In gum, emulsifiers primarily act to soften the gum base through eutectic interactions with lipid components. They also promote water retention and hydration of the gum base during chewing. Emulsifiers can also act as carriers for colors and flavor aiding in the dispersion of these important ingredients within the gum base. Common emulsifiers added to gum base include lecithin, glycerol monostearate, and acetylated monoglycerides. Up to 1% lecithin can be used to soften chewing gum to the desired consistency (Patel et al., 1989) and can be hydrated or mixed with a vegetable oil or suitable fatty emulsifiers, such as mono and diglycerides, to aid in dispersion within the chewing gum. Chewing gums prepared in this way have the desirable soft, chewy properties popular in today's top products.

Other emulsifiers are also used in chewing gum to provide suitable textural and anti-stick properties to the chewing gum base; these include mono- and diglycerides, glyceryl lacto palmitate, sorbitan monostearate, triglycerol monostearate, triglycerol monoshortening and polysorbates 60, 65 and 80.

Lecithin may also be used to provide a protective coating to chewing gum pieces prior to a hard panning process to lay down a candy coating (Dave et al., 1991). Normally only hard chewing gums can be hard panned in this way but by using a hydrated lecithin coating it is possible to candy coat and then allow the lecithin to soften the chewing gum in storage prior to consumption. The emulsifier coating when dried hard forms a suitable base for syrup-based candy coatings.

10.6.1 *Caramel, Fudge, and Toffee*

The unique characteristic of caramel, fudge and toffee comes from the controlled heating of dairy ingredients in the presence of sugar syrup. The resulting Maillard browning products provide both characteristic color and flavor. Concentrated milk products, such as evaporated or sweetened condensed milk, are the primary dairy ingredients used in caramel and fudge manufacture. Butter is the dairy ingredient added in toffee production.

Caramel is an amorphous sugar confection containing finely dispersed fat globules held in place by a combination of aggregated proteins and the high viscosity of the amorphous sugar matrix. Fudge is essentially a grained caramel, with the dispersion of fine sugar crystals providing the “short” texture of fudge. Some commercial caramels actually contain a small amount (perhaps 5–10%) of sugar crystals to moderate the chewy texture. Toffee is essentially a glassy sugar matrix holding the dispersed fat globules.

Fat content of caramel and fudge may be between 6 and 20%, although most commonly fat content is 10–15%. In toffee, fat content is as high as 40%. The fat in caramel provides lubricity, making the candy easier to process by preventing stickiness. The fat also aids in chewing, preventing the caramel from sticking to the teeth. The partially-crystalline fat globules, in conjunction with aggregated proteins that surround each fat globule, provide the stand-up properties of caramel and help prevent cold flow. Fats also contribute to the flavor of these confections. Although milk fat typically gives the highest quality cooked dairy flavor, many commercial products are made with vegetable fats to cut costs.

The addition of emulsifier in the formulation for caramel, fudge and toffee ensures adequate breakdown of the fat into small, well-dispersed fat globules during manufacture. Many commercial caramels are homogenized, breaking down the fat globules under pressure. The presence of emulsifier helps reduce interfacial tension of the fat droplet, allowing them to be broken down into smaller globules. The natural emulsifying properties of milk also contribute to breakdown of the fat globule emulsion. Emulsifiers also help against coalescence of the dispersed fat globules, particularly during processing. It is not an uncommon sight to see a layer of fat forming on a batch of toffee during cooking as some of the emulsion breaks. Sometimes, further shearing can fold this separated fat back into the mass, with addition of a little more lecithin providing enhanced emulsification. Once the candy has solidified, the solid-like characteristics of the continuous sugar matrix are the main stabilization mechanism.

The most common emulsifier, by far, found in caramel, fudge and toffee is lecithin. A common usage level is about 0.25–0.5% of the batch weight. Monoglycerides (e.g., glycerol monostearate) and diglycerides may also be used in these confections, usually at slightly higher levels (1–2%). Mono- and diglycerides are often used in low-fat confections to improve lubricity and mouthfeel.

10.6.2 Starch Candies

Starch is used as a texturing agent in a number of confections, including jelly candies and licorice. The gelation of starch after disruption of the starch granule provides the desired textural properties to starch-based confections, such as jelly bean centers, fruit slices, and gum drops. Numerous starch modification technologies have been used to moderate these textural properties.

Some emulsifiers and surface-active agents, such as GMS and Saturated Ethoxylated Monoglycerides or polyglycerate 60, are absorbed onto starch granules. This property can be used to modify the texture of starch-based sugar confectionery. Gel formation in starch-based jellies and gums is mainly due to amylose, the water-soluble fraction of starch. Interaction between amylose and emulsifiers creates a water-insoluble complex, and creates an irreversible textural effect. This interaction was quantified by Krog (1977) with the amylose-complexing index, or ACI. The ACI is defined as the percentage of amylose precipitated at 60 °C after 1 h and after reacting 5 mg of the emulsifier with 100 mg of amylose. See Table 10.4 for ACI values of some common emulsifiers. Perhaps because of this complexation, emulsifiers like GMS also are known to retard recrystallization of starch after gelatinization.

To be an active amylose-complexing agent, an emulsifier must have a high level of saturated monoglycerides and some degree of water dispersibility. An example of the use of emulsifiers in starch-based confectionery is in the making of Turkish delight, where it is possible to use emulsifiers with high ACI values (like GMS) to avoid pastiness or cheesiness. Usage levels are typically 0.025%.

Recently, Azizi and Rao (2005) studied the pasting characteristics of various starches (wheat, corn, potato) in the presence of emulsifiers. The emulsifiers studied, added at 0.5% on a starch basis, included sodium stearyl-2-lactylate (SSL), glycerol monostearate (GMS), distilled GMS (DGMS) and diacetyl tartaric esters of monoglyceride (DATEM). In all cases, gelation temperature increased in the presence of emulsifiers. For example, addition of SSL caused gelation temperature of wheat starch to increase from 68.65°C to 86.30°C. At the same time, peak viscosity decreased and cold past viscosity increased significantly with addition of emulsifiers. In most cases, hot paste viscosity also decreased with added emulsifier, except for potato starch, where all emulsifiers studied caused an increase in hot paste viscosity. The authors concluded that HLB and charge of the emulsifier both influenced the nature of the starch gels produced, and that a range of textural properties could be produced through choice of emulsifier and starch type.

Licorice is a flour-based starch confection that contains licorice extract. Fruit-flavored licorice-type candies also fall into this category and make up a significantly larger market than true licorice. In these products, the starch granules are

Table 10.4 ACI values of some food emulsifiers

Glycerol monostearate (85%)	87
Glycerol monooleate (45%)	35
Mono and diglycerides (50% monoester)	42
DATEM	49
Sorbitan monostearate	18
Lecithin	16
Polysorbate 60	32
Acetylated monoglycerides	0

only partially pasted, or gelatinized, to yield a chewier texture than found in starch jellies. The protein in the flour also imparts some of the chewiness in the finished product. A small amount of fats may be added to some licorice products to reduce stickiness and enhance chewing properties, although distilled monoglycerides serve the same purpose (Jackson, 1986) and may be used in conjunction with fats. Emulsifiers also delay hardening during shelf life. Based on the Azizi and Rao (2005) study discussed above, emulsifiers can also influence gelatinization temperature and may provide additional control of product texture.

10.6.3 Nougat and Chewy Candies

Nougats, fruit chews, chocolate chews and taffy-type products are lightly aerated candies often designed to have chewy texture. They often have no crystalline grain or may be lightly grained to modulate the chewy characteristics. Many of this class of products have anywhere from 3 to 10% fat added to reduce stickiness, enhance processability and minimize candy sticking to the teeth during consumption. To enhance the effects of fat and to ensure adequate dispersion of the fat in these products, it is common to add 0.1–0.2% emulsifiers like lecithin, mono- and diglycerides and/or GMS.

Aeration of protein systems containing small amounts of fat, such as nougats, can be facilitated by the addition of triglycerol monostearate. However, liquid fat or lipophilic emulsifiers such as GMS or acetylated monoglycerides usually tend to destabilize foams and cause deaeration. If used in aerated products, lipophilic materials must be carefully blended into the aerated candy to minimize deaeration.

10.7 Processing Aids

Emulsifiers are sometimes used in very small amounts in confectionery products either to control aeration or to prevent product sticking to machinery and packaging. They can also be used to displace starch from starch-molded jellies and gums and provide a shiny attractive appearance as well as a barrier to degradation from atmospheric oxygen and moisture.

Emulsifiers are also useful release agents providing barrier properties between product and moulds, tables, metal, conveyor belts, utensils and machinery especially on cooling. Release agents must be food grade materials and have high stability to resist oxidation and hydrolysis.

Acetylated monoglycerides are used as release agents or as oiling and polishing agents because they form stable films on the surface of confectionery items. They have α -crystalline stability, a plastic, nongreasy texture and neutrality of flavor, color and odor. They reduce shrinkage, hardening through moisture loss, and prevent fat degradation and mould growth. They retain moisture and other desirable

properties of the foodstuff and prevent contamination by moisture or dust. They are usually applied directly to the confectionery product by spraying. Melting points used are in the range of 30–46 °C. Typical applications include nuts, dried fruits and certain panned confectionery items. Lower melting point forms (10 °C) can be sprayed directly onto conveyers and molds to release goods with high sugar contents such as fondant creams and jellies.

Another release agent used often on chocolate-enrobing tunnels is a mixture of lecithin and cocoa butter. This is sprayed onto the band before the candy center is deposited to ensure clean separation of the centers from the band prior to chocolate enrobing.

10.8 Summary

Emulsifiers play a significant role in the processability and functionality of both chocolate-based and sugar-based confections. Typically, lecithin, PGPR, and mono- and diglycerides are the main emulsifiers used in confections, but numerous other emulsifiers have been studied and shown effective in certain applications.

Emulsifiers in confections can play many roles, including:

- *emulsification and controlling oil separation*: emulsifiers reduce droplet size and stabilize fat droplets in products such as caramel, fudge, toffee and chewy candies;
- *lubrication and reduced stickiness*: emulsifiers reduce stickiness of various confections (nougats, chews, caramel, etc.) during processing as well as during consumption;
- *plasticizer and hydration agent*: in gum, emulsifiers soften gum base and enhance hydration of the bolus during chewing;
- *viscosity control*: in chocolates and compound coatings, small amounts of emulsifiers like lecithin and PGPR reduce yield stress and plastic viscosity and control flow properties;
- *crystal modifier and bloom inhibitor*: primarily in compound coatings, certain emulsifiers influence fat crystallization during processing and can delay bloom formation; and
- *release agent*: liquid emulsifiers can be sprayed onto handling equipment to prevent sticking and release of candy pieces from molds.

References

- Anon. (1991a). *Confectionery Production*, 57(2): 136–137, 140.
Anon. (1991b). *Confectionery Production*, 57(6): 451–452.
Azizi, M.H. and Rao, G.V. (2005). *Food Hydrocolloids*, 19: 739–743.
Babin, H., Dickinson, E., Chisholm, H. and Beckett, S. (2005). *Food Hydrocolloids*, 19: 513–520.

- Bamford, H.F., Gardner, K.J., Howat, G.R., and Thomson, A.F. (1970). *International Chocolate Review*, 25(6): 226–228.
- Berger, K.G. (1990). World Conference on Oleochemicals into the 21st Century, American Oil Chemists Society, Champaign, IL, pp. 288–291.
- Bonekamp-Nasser, A. (1992). *Confectionery Production*, 58(1): 66, 68.
- Bradford, L. (1976). *International Flavors Food Additives*, 7(4): 177–179.
- Chevalley, J. (1988). Chocolate flow properties. In: *Industrial Chocolate Manufacture and Use* (S.T. Beckett, Ed.), Blackie, Glasgow and London, pp. 142–158.
- Dave, J.C. et al. (1991) US Patent 5, 135, 761, March 28.
- Dziezak, J.D. (1988). *Food Technology*, 42(10): 171–186.
- Garti, N. (1988). Effects of surfactants on crystallization and polymorphic transformation of fats and fatty acids. In: *Crystallization and Polymorphism of Fats and Fatty Acids* (N. Garti and K. Sato, Eds.), Marcel Dekker, New York, pp. 267–304.
- Garti, N. and Yano, J. (2001). The roles of emulsifiers in fat crystallization. In: *Crystallization Processes in Fats and Lipid Systems* (N. Garti and K. Sato, Eds.), Marcel Dekker, New York, pp. 211–250.
- Garti, N., Schlichter, J. and Sarig, S. (1986). *Journal of American Oil Chemists' Society* 63(2): 230–236.
- Geisler, A. (1991). The magic of lecithin. 45th PMCA Production Conference, Pennsylvania Manufacturing Confectioners Association, pp. 116–119.
- Harris, T.L. (1968). Surface Active Lipids in Foods. Monograph No 32, Society of Chemical Industry, England.
- Herzing, A.G. et al. (1982) U.S. Patent 4,464,411, November 5.
- Hogenbirk, G. (1989). *Confectionery Production*, 55(1): 82–83.
- Jackson, E.B. (1986). Influence of raw materials on licorice. 40th PMCA Production Conference, Pennsylvania Manufacturing Confectioners Association, pp. 40–44.
- Jeffery, M.S. (1991). *Manufacturing Confectioner*, 71(6): 76–82.
- Kleinert, J. (1976). *Rheology Texture Food Quality*, pp. 445–473, AVI, Westport, CT.
- Krog, N. (1977). *Journal of the American Oil Chemists' Society*, 54: 124–131.
- Lees, R. (1975). *Confectionery Production*, 41(6): 296, 298, 304.
- Lonchamp, P. and Hartel, R.W. (2004). *European Journal of Lipid Science and Technology*, 106: 241–274.
- Minifie, B.W. (1980). *Manufacturing Confectioner*, 60(40): 47–50.
- Moran, D.P.J. (1969). *Revue Internationale Choc. (RIC)*, 24: 12.
- Musser, J.C. (1980). 34th PMCA Production Conference, Lancaster, PA, pp. 51–60.
- Nakanishi, Y. (1971). *Revue Internationale Choc. (RIC)*, 26: 8.
- Patel, M.M. et al. (1980) US Patent 5, 041, 293, December 28.
- Player, K. (1986). *Manufacturing Confectionery*, 66(10): 61–65.
- Rector, D. (2000). Chocolate—Controlling the flow: Benefits of polyglycerol polyricinoleic acid. *Manufacturing Confectioner*, 80(5): 63–70.
- Rousset, P., Sellapan, P. and Daoud, P. (2002). Effect of emulsifiers on surface properties of sucrose by inverse gas chromatography. *Journal of Chromatography A.*, 969: 97–101.
- Schantz, B. and Rohm, H. (2005). Influence of lecithin-PGPR blends on the rheological properties of chocolate. *Lebensmittel Wissenschaft und Technologie*, 38: 41–45.
- Seguine, E.S. (1988). Casson plastic viscosity and yield value. *Manufacturing Confectionery*, 68(11): 57–63.
- Talbot, G. Smith, K.W. and Cain, F.W. (2005). Fat bloom on lauric coatings: Structure and control. *Manufacturing Confectionery*, 85(1): 69–72.
- Timms, R.W. (2003). *Confectionery Fats Handbook*, The Oily Press, Bridgwater, England.
- Weyland, M. (1994). *Manufacturing Confectionery*, 74(5): 111–117.
- Woods, L.C. (1976). *Gordian*, 76(2): 53–57.)

Chapter 11

Margarines and Spreads

Niall Young and Paul Wassell

11.1 Introduction

The application margarine and spreads refers to a series of products, which are likened to butter, but have different fat contents. The definition of margarine is rigidly fixed with regards to fat content, a minimum of 80% by weight must be present, but the rheological characteristics of margarine can range from liquid to plastic in nature. Any edible oil or fat source may be used in its manufacture.

The definition of spreads is more ambiguous since they may contain a wide variety of fat contents, thus promoting the low fat, and reduced fat spread concept. This typically refers to anything between 25 and 70% fat content, but today modern demands often exist for even lower fat levels.

Margarine was invented in response to a request from the French Government of Napoleon III for a less expensive, longer life replacement for butter. The invention, credited to Hippolyte Mège-Mouriez, took place around 1860s and focussed on the rendering of tallow fat by artificial gastric juices, a crystallisation step at ambient temperature and extraction under pressure to obtain oleomargarine, a semi-fluid fraction and oleostearine, a hard white fat in the ratio of 60:40 respectively. The softer fraction was noted to have a flavour not dissimilar to butter fat, a similar melting point and a typical pale yellow colour, and the material could easily be plasticised. Thus, it represented a firm foundation material for the production of a butter substitute. The material was thought to contain glycerides of margaric acid, but it is now established that the fatty acid content is made up from palmitic and stearic acids—but nonetheless the name margarine has stuck.

Using this fat source as the base, Mège-Mouriez mixed varying amounts of milk and water to the fat, stirred the mixture and formed a thick but stable emulsion, which upon further churning took on the consistency and resemblance of butter. Thus, the butter substitute that is margarine was formed, and essentially the production of margarine today follows the same basic trends.

As the patenting and production of margarine became established throughout the 1870s to 1880s in both Europe and the US, not everyone was pleased by this new, ‘anti-butter’ arrival and opposition groups were formed to combat its use and application. These groups stemmed particularly from the farming and agriculture

communities and ended up with anti-margarine legislation being adopted, which continued well into the twentieth century!

11.2 The Rise of Margarine

The restrictions placed on the sale and manufacture of margarine, especially in the early part of the twentieth century, had an impact on the general consumption rate, but the overall trend was that of an increase in margarine consumption over butter. Butter held out until the end of the Second World War, with parity being reached around the mid 1950s, and then margarine moved to take a clear lead over butter. As is highlighted in Table 11.1, the margarine consumption rates peaked over a three-decade period from the 1970s to the 1990s, and thereafter the consumption rate in the USA has tailed off, but is still higher than for butter.

Similar trends can be seen within Europe, as indicated by Fig. 11.1, based on production figures as opposed to consumption. The reason attributed to the decline of butter and the rise of margarine, or at least spreads is related to the trend to reduce fat content from one's diet. This is linked to the issues that surround saturated fats, and not least the current hot topic of requiring foods to be *trans* free, i.e. fatty acids should not contain *trans* double bonds (see Sect. 11.4) within their molecules.

Table 11.1 Average butter versus margarine consumption in the United States from 1930 to 2003, expressed in lbs per capita

Year	Butter	Margarine
1930	17.6	2.6
1935	17.5	3.0
1940	17.0	2.4
1945	11.7	3.9
1950	10.9	6.1
1955	9.3	8.0
1960	7.7	9.3
1965	6.6	9.8
1970	5.4	10.8
1975	4.7	11.0
1980	4.5	11.3
1985	4.9	10.8
1990	4.4	10.9
1995	4.5	9.1
2000	4.5	7.5
2001	4.5	7.0
2002	4.5	6.5
2003	4.2	6.2

Source USDA Economic Research Service (2004)

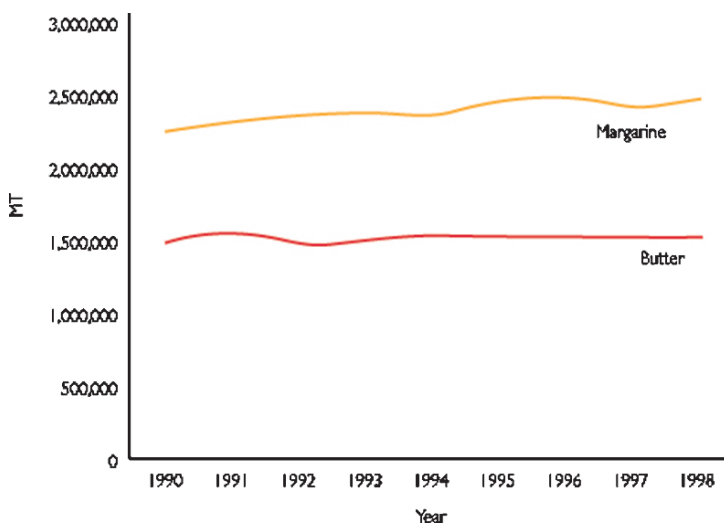

Fig. 11.1 Comparison between production of butter and margarine within the EU-15 nations. Courtesy of International margarine association of the countries of Europe, IMACE

11.3 Terms and Terminology

As with any branch of science the operating terms can be confusing to the layperson, and therefore the regulation of them is aimed to unify and standardise the field. The public tend to refer to spreads as margarine even when they are not, often in the ignorance that they are incorrect. The current description for the whole category is termed spreadable fats, and this includes butter. These spreadable fats are further described as a solid, but malleable emulsion, where the fat content must be at least 10% but less than 90%. This excludes the very low fat content of some of the water continuous spreads. Further physical specifications are placed on the spreadable fats in that they must be both solid and spreadable at a temperature of 20 °C, and more often they must be spreadable at refrigeration temperatures, i.e. <5 °C.

The definition of margarine has been established for over a century now, and is regarded as being similar to butter, i.e. it has a fat content of at least 80%. Anything under this fat content, by definition, is not margarine, but must be referred to as a spread, low fat or otherwise. Here, the modern legislation is complex and terms such as three-quarter fat, half-fat and fat content X% are routinely seen. Without entering into individual national semantics, it is fair to say that three-quarter fat refers to a fat percentage of 60–62%, half-fat to 39–41% specifically. Reduced fat falls within the range 41–62%, and low fat or light products under 39%. Overall, there is a general consensus that a fat spread product, be it butter, margarine or other must have a fat content between 10 and 90%. These options are summarised in tabular form in Table 11.2. It is worth stating that within the reduced to low fat

Table 11.2 Product type versus their fat content in percent

Product Type	Fat content (%)
Butter	80 ^a
Margarine	80 ^a
Three-quarter fat	60–62 ^a
Half-fat	39–41 ^a
Reduced fat	>41 to <62 ^a
Low fat/Light	<39 ^a
Very Low Fat	20–30 ^b
Water Continuous	10–15 ^b

^a Article 5 of the Council Regulation (EC) No. 2991/94, laying down standards for spreadable fats

^b Other industry classifications

region a range of ‘functional’ spreads are being routinely created to address cholesterol issues by adding sterol or stanol esters. Other trends see the incorporation of probiotic cultures for improving gut flora and general well being, and there is the continued trend of increasing the content of specific functional fatty acids such as omega-3’s derived from marine sourced Long Chain Poly Unsaturated Fatty Acids (LCPUFA), and conjugated types.

11.4 Building Blocks and Structure

Margarine is classified as a water-in-oil (W/O) emulsion. A W/O emulsion is characterised as having the water phase, the dispersed phase, being distributed within the fat or oil phase, the continuous phase, as droplets. We have established that the fat content of the margarine is equivalent to butter, 80%, but the moisture content is held to a maximum of 16% and the remaining 4% is a complex mix of proteins, emulsifiers, salts, flavours, colours and vitamins. Understanding the chemistry and mechanics of the fat phase is therefore important for producing a stable margarine/spread product.

The oil blends within margarines are not static, as this is governed by the market situations, price, availability and other factors. Hence, it is important to be able to utilise different oils as circumstances dictate, and therefore it is necessary to understand the physical properties of the oils and fats being used, i.e. their crystallisation rates, melting properties as well as solid/liquid fat ratio.

11.4.1 *The Oils and Fats*

Both oils and fats are triglycerides, and are liquid and solid at ambient temperatures, respectively. The building blocks, i.e. monoacyl glycerides are shown

oils and fats manufacturer a greater flexibility and the chance to dramatically alter the melting point of the fat. The fatty acid composition of some natural fats along with other important information is summarised in Table 11.3. Given current trends, the down side to hydrogenation is that during the addition of hydrogen, *trans* fatty acids, which are schematically shown in Fig. 11.4, are formed. Selective hydrogenation involves the saturation of the most polyunsaturated fats first, such that the *trans* fatty acid concentration increases up to a point until they themselves are hydrogenated. If the reaction runs to completion, then the *trans* isomer is absent. The *trans* fatty acids can have substantially higher melting points than the corresponding *cis* fatty acid, where the difference can be in excess of 30 °C! *Trans* free fat blend alternatives have been reviewed by Wassell and Young (2007).

Over and above the physical aspects of *trans* fatty acids, new ruling in the United States, valid from 1st January 2006 requires all food stuffs to have the *trans* fatty acid content labelled. This requirement is in response to studies that show human intake of *trans* fatty acids, similar to that of saturated fatty acids increases the concentration of low density lipoprotein cholesterol (LDL-C) in the blood. This is colloquially referred to as the 'bad cholesterol'. The regulation states that the content of the *trans* fatty acids must be recorded to the nearest gram if the serving contains 5 g or more of the fatty acid. If the content is below 5 g then the *trans* content must be declared to the nearest 0.5 g and if the content is below 0.5 g then it can be declared 0 g, and "not a significant source of *trans* fat" may be used. Herein, there is still scope for margarine technology to play a part in delivering less fat per serving and actually allows the use of higher *trans* content oils (Klemann, 2004)!

Table 11.3 gives the melting points of the individual oils that are used to make up the fat blends, but it is also important to know and recognise the melting points of the fatty acids themselves. These are outlined together with the number of double bonds they contain in Table 11.4.

11.4.2 Fat Crystallisation

This is a hugely important area, which basically governs the texture of the margarine or spread. Topics discussed in this section will cover aspects of crystal form, crystal size and crystal binding. Understanding the crystallisation procedure will ease the processing of the individual oil or fat since there can be differences and variations in crystallisation rates from batch to batch and there are differences from oil to oil.

Fat crystals are polymorphic, having the following forms, α , β' , and β , where the melting point increases in the respective order written. The difference in melting points between the different fatty acids can be large, such that for $C_{18:3}$ (Linolenic acid) to C_{22} (Behenic acid) the difference in melting point of the β form is more than 100 °C. The conformation of the fat crystals can be viewed as being like a chair, (van Soest et al., 1990) and they are packed in units of two. These are schematically shown in Fig. 11.5, where Fig. 11.5a shows the structure of fats normally used in the margarine industry whereas Fig. 11.5b shows that for cocoa butter. Also present in Fig. 11.5

Table 11.3 Composition of fatty acids in vegetable oils and fats, together with other important information

Fatty acid	Castor oil	Coconut Oil	Palm kernel oil	Palm Oil	Ground-nut oil	Cotton-seed oil	Soya bean oil	Sunflower oil	Linseed Oil	Rape-seed oil
Caproic C ₆	0.5 ^a (0.2–0.8) ^b	0.5 (T–1.6)								
Caprylic C ₈	8 (6–9)	4 (3–10)								
Capric C ₁₀	7 (6–10)	5 (3–14)								
Lauric C ₁₂	48 (44–51)	50 (37–52)								
Myristic C ₁₄	17 (13–18)	15 (7–17)	2 (0.5–5)	1 (0.5–2)	T	T	0.5 (0–1.5)			
Palmitic C ₁₆	2 (1–2)	9 (8–10)	7 (2–9)	42 (32–47)	10 (7–12)	21 (20–27)	8 (7–10)	6 (4–8)	5 (4–7)	2 (1–4)
Stearic C ₁₈	1 (1–2)	2 (1–3)	2 (1–3)	5 (2–8)	3 (2–6)	2 (1–3)	4 (3–6)	4 (2–5)	4 (2–5)	1 (0.5–2)
Arachidic C ₂₀		T (T–0.6)	3 (2–4)	0.5 (0.2–1)	0.5 (0–2)	0.5 (0–1)	T	0.5 (0–1)		
Behenic C ₂₂		2 (T–3)	2 (T–3)			0.5 (0–1)		1 (0.5–1.5)		
Lignoceric C ₂₄		T	2 (1–3)					T	1 (1–2)	
Palmitoleic C _{16:1}		0.2 (T–0.4)	0.5 (T–0.6)		T	0.5 (0–2)	0.5 (T–1)	T		T
Oleic C _{18:1}	7 (T–8.5)	7 (5.5–7.5)	15 (11–23)	41 (40–52)	50 (35–70)	29 (22–35)	28 (20–35)	28 (20–40)	22 (12–34)	15 (11–24)
Gadoleic C _{20:1}										7 (5–12)
Euric C _{22:1}										50 (40–55)
Ricinoleic C _{18:1}	87 (86–92)									
Linoleic C _{18:2}	3 (3–6)	1.3 (T–2.5)	1 (1–3)	10 (5–11)	30 (20–25)	45 (42–54)	53 (40–57)	61 (45–68)	17 (14–20)	15 (11–29)
Linolenic C _{18:3}						1 (T–2)	6 (5–14)	T	52 (35–65)	7 (6–13)
Pure Glycerine	8.8–9.8	13.2–13.5	12.2–12.8	5.5–10.0	8.7–9.9	10.6	10.2	10–12	0.4–10.5	9–9.7
I ₂ value (Wijs)	81–91	7.5–10.5	14–23	44–54	84–100	99–113	120–141	126–136	55–205	97–108
Saponification value	177–187	250–264	245–255	195–205	188–195	189–198	189–195	186–194	188–196	170–180
Melting point °C	–10 b, –12	23–26	24–26	27–50	–2	–2b, + 2	–20 b, –23	–10	–20	–9
Titer °C		20–24	20–24	40–47	26–32	30–37	20–21	16–20	19–21	11–15

T = trace (Madsen, 2003)

^arefers to the typical value—valid throughout the entire table^brefers to the range due to natural variability—valid throughout the entire table

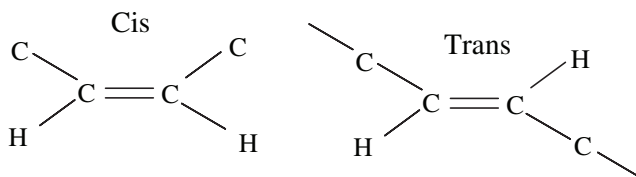

Fig. 11.4 Schematic diagram of *cis* and *trans* configurations

Table 11.4 Common fatty acids showing their melting points and the number of double bonds they naturally contain

Fatty acid	No. of double bonds	Melting point °C
Lauric C ₁₂	–	44.2
Myristic C ₁₄	–	54.3
Myristoleic C _{14:1}	1	Liquid
Palmitic C ₁₆	–	62.9
Palmitoleic C _{16:1}	1	Liquid
Stearic C ₁₈	–	69.6
Oleic C _{18:1}	1	16.2
Linoleic C _{18:2}	2	Liquid
Linolenic C _{18:3}	3	Liquid
Arachidic C ₂₀	–	74.4

is an indication of the long spacing, (LS), which is the length of the triglyceride unit in the triglyceride row of a crystal. The angle of tilt, t , will depend on the LS value such that larger LS values result in smaller angles of tilt and vice versa.

The short spacings, shown schematically in Fig. 11.6, represent distance between the fatty acid chains, and these can accurately be measured by X-ray crystallography. The typical values of the short spacings of the three crystal types are: α - 4.15Å, β' - 3.8Å and 4.2Å, and β - 4.6Å. α , β' , and β crystals (Hoerr, 1960) can be formed directly from the melt, or α to β' to β , but this is not reversible. By measuring the short spacings between the fatty acids, one can ascertain and quantify the type and ratio of the fat crystal forms one has in a given blend. Through similar techniques it has been established that margarines and spreads are preferred with crystal polymorph that exists in the β' form. The influence of processing however can have dramatic impact on crystallisation kinetics. For example, if the fat blend contains beef tallow, then the crystals are β' in margarine made with a tube chiller, but β in margarine made with a chilling drum. Palm oil is probably the most widely used of vegetable oils, and it is naturally β' tending largely because of its diverse fatty acid profile, and particularly high content of palmitic acid (Berger and Idris, 2005). However, if processed incorrectly, these benefits are lost, and because palm oil also contains unusually high content of diglycerides ~6–7%, the diglycerides have anti-crystallisation properties that can negatively influence crystal kinetics (Siew, 2002). Therefore the correct processing approach is necessary when using palm oil.

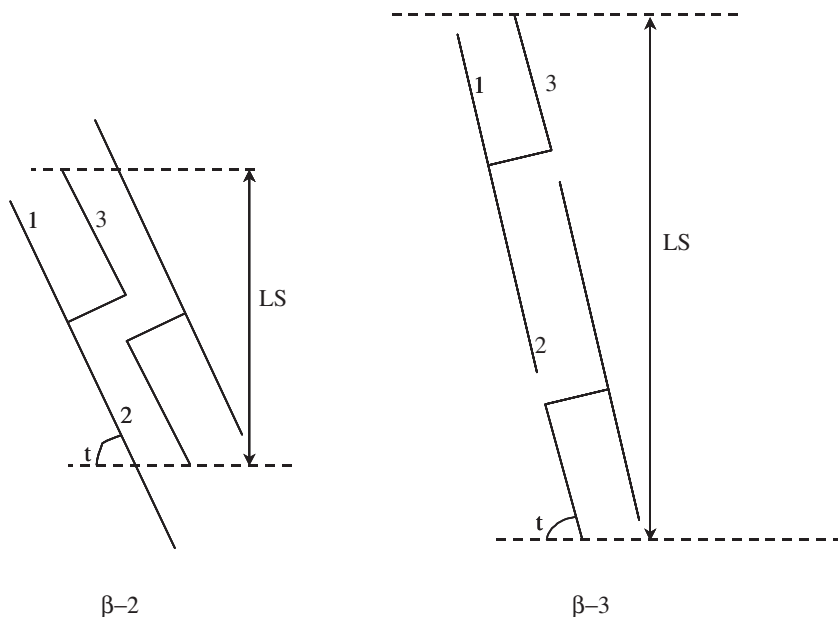

Fig. 11.5 Arrangement of triglycerol molecules in the $\beta-2$, and $\beta-3$ modifications, where LS is the long spacing, t is the angle of tilt, and 1, 2, and 3 represent the triglyceride configuration

The different crystal types, α , β' , and β each have their own configurations (see Fig. 11.7) (Hernqvist, 1988), and it is well known that fat crystals with similar chain lengths, e.g. hydrogenated sunflower oils transform more quickly from the β' to β form. This is similarly true for hydrogenated low euric acid rape-seed oil (Yap et al., 1989). This property is attributed to the uniform end layers between the triglyceride rows in the crystal. It is similarly well known that sorbitan tristearate (STS) esters co-crystallise with the triglyceride, and because of their irregular molecular form compared with triglyceride, prevent the 90° rotation of the triglyceride, thus helping to delay transformation from the β' to β form (Madsen and Als 1968).

As the crystal form changes, the texture likewise changes. This typically takes place under storage and the usual transition is from β' to β . During this transition crystal size increases dramatically, from $\sim 3-5\mu$ to $\sim 100\mu$ respectively, as does melting point. The result is that the margarine now has a sandy/gritty type mouthfeel.

The crystals in margarine, spreads and shortenings are bound together by a network of crystal-to-crystal contact bindings. The functionality of the semi-solid margarine, termed plastic fat, is influenced by the ratio of liquids to solids in the lipid phase, and the crystal packing arrangement developed during processing (Timms, 1991). Control of crystal form, size, and shape must be balanced with careful blend selection, and are critical for final application in bakery products. Often these inter-crystal associations are classified as primary (irreversible) and secondary (reversible) bindings, which can be reliably measured using creep-recovery techniques (Marangoni, 2005).

A high content of secondary bindings is desirable in puff pastry type margarine because they allow the margarine to maintain a high degree of plasticity under rolling of the puff pastry dough. A degree of both primary and secondary bindings is

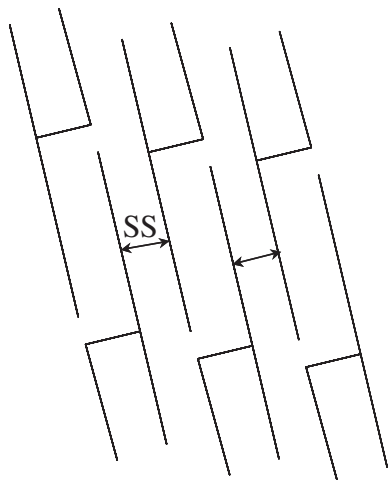

Fig. 11.6 Fatty acid units showing the short spacing between the individual fat units

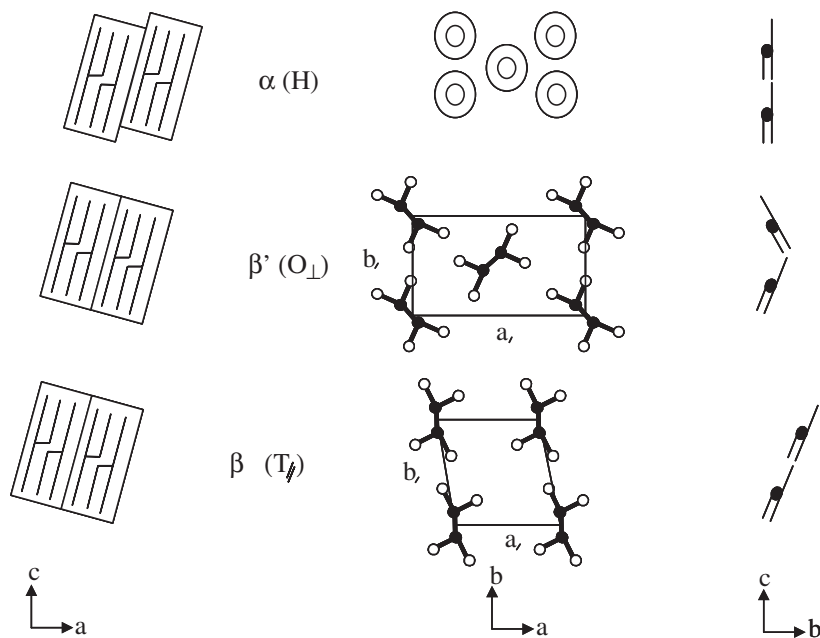

Fig. 11.7 The three projections of α , β' , and β crystal forms. (With Permission from Leatherhead Food International, UK.)

beneficial in cake margarine so that the margarine becomes soft, thus facilitating air incorporation during whipping with sugar.

11.5 Emulsifiers

Emulsifiers are used in all types of margarine and spreads to stabilise the liquid emulsion by reducing the interfacial tension between the fat and the water phases. The emulsifiers secure a fine and stable water phase dispersion, thus ensuring a homogeneous margarine/spread product with good functional, and overall microbiological keeping properties (Bot et al., 2003). Different types of margarine require different emulsifiers depending on which criteria are to be met. In frying margarine, water droplet size and distribution are controlled to thereby minimise spattering, which tends to plague this application (Chrysam, 1996). In reduced fat spreads, the water content is higher than in retail table margarines and therefore the emulsifier is used primarily to bind the water and secure a stable reduced fat spread. For all-purpose, full-fat table margarine, and industrial cake margarine, a requirement of the application is that the emulsifier should impart good whipping properties. Therefore, it is essential for the emulsifier to ensure a good volume and uniform structure within the cake dough mix (Tamstorf et al., 1986). The cake recipe and flour type, and method of manufacture may similarly influence the type of emulsifier chosen for the margarine. Common to all though, is the dispersion of the water phase as droplets within the continuous oil phase.

The stability of the W/O emulsions is kinetic as opposed to thermodynamic, i.e. the system is thermodynamically unstable. If the system was to be thermodynamically stable, the emulsion should spontaneously reform after mechanical separation by means of centrifugation. However, experience shows that systems separated by centrifugation tend to remain that way unless mixed by external forces. In truth when the emulsion is separated into its two distinct phases, this is its naturally most stable state, and indeed the state towards which it will tend, over time. Hence, a stable emulsion is almost a contradiction of terms and basically refers to a system where the inevitable phase separation has been severely retarded such that it is imperceptible over the shelf life of the product, even if this is a period of years!

A range of emulsifiers are available for use in margarine and spread systems, and as the fat content is reduced and enters the low fat spread area, stabilisers for the water phase will also be required. Taking the emulsifiers first, one can choose from distilled mono-, di-, and triglycerides, polyglycerol esters, lactic acid esters, citric acid esters, polyglycerol-polyricinolineate, propylene glycol monostearate, and sorbitan tristearate, among others.

The distilled monoglycerides are sourced from refined and commercially available edible oils, such as sunflower oil, palm oil, rape-seed oil, vegetable oil, soy oil and animal sources, and work generally as an all-purpose emulsifier. They stabilise the liquid emulsion in water-containing systems by reducing the interfacial tension between the fat and the water. Simultaneously, they prevent syneresis in aerated and hydrated systems as well as facilitating the incorporation of other ingredients into the fat fraction. Coalescence can also be minimised, as in the case of frying margarines.

Depending on the selected emulsifier, it can also improve textural properties, resulting in a less waxy mouthfeel.

The lactic acid esters of mono-diglycerides are produced by reacting a full or partially hydrogenated vegetable oil with lactic acid to one or several hydroxyl groups. Its function is more in the final application than necessarily in the margarine fraction itself. Incorporation of the lactic acid esters reduces the whipping time required for creams, and cake batters, and it increases the degree of overrun obtained and improved overall foam stiffness. Lactic acid esters will also improve crumb firmness in the baked cake over time.

The citric acid esters of mono-diglycerides are produced from edible refined vegetable fats or sunflower oil, and are primarily used as replacers for lecithin. Through the citric acid esters the fat fraction and solids fraction becomes efficiently integrated resulting in a smooth, homogeneous and easy to handle system. Within margarine products themselves the citric acid esters are excellent anti-spatter agents.

By treating individual applications special focus can be placed on the type of fat blend used, the conditions that are required from the margarine or spread and therefore the emulsifiers that are chosen to meet these requirements. Independently, there are wide ranging processes and dynamic conditions that also require discussion, this has already been adequately dealt with by Flack (1997).

11.6 Industrial Cake and Cream Margarine

This margarine is used in pound cakes, fillings, and short crust pastry etc. and by nature of the products need to have air incorporated into them. This requires the margarine to work at the temperatures of usage and also allow the incorporated air to be retained within the structure of the cake batter. Similarly, the margarine should prevent the formation of long chains of gluten networks, thus ensuring the final product is crumbly to the bite.

Here the fat blend must provide stability over a wide temperature range, but must ensure the margarine is soft and easy to work with, and easily disperses into the cake batter, whilst imparting optimum stability to the cake batter. The stabilising effect takes over during baking, whereby the unit structure of the final cake becomes fixed because of gelatinised starch being cemented together with the protein matrix. The stabilising effect of the fat during batter preparation now serves as a lubricant mechanism, coating the individual flour particles, thus preventing them from forming extended gluten network formations.

Firmer cake margarines are available for cookies and biscuits, where the aeration capability may or may not be important. Ease of the margarine's incorporation into the batter is still of primary importance.

Lauric oils, i.e. those from coconut oil and palm kernel oil, are well known to have good whipping properties because they are by definition, high in short chain C_{12} fatty acids. However, lauric oils are also known to be prone to hydrolytic rancidity, (Britannia Food Ingredients Ltd., 2000), which imparts an unpleasant flavour to the

margarine but also the final product. Modern refining techniques are able to overcome this problem.

The overall fat content of cake margarines has tended to decrease in recent years, with the advent of low fat products, down to 60% fat products. However, reducing the fat content increases the water content and thereby reduces the whipping ability and baking properties of the final cake. Hence, addition of other ingredients to bind the water and essentially act as fat substitutes are required. The ingredients of choice are hydrocolloids, which stabilise the water phase, and allow for cakes to be made with similar volume and crumb structure to the standard 80% fat versions.

In order to achieve the above, usually it is necessary to use more than one emulsifier and typically a combination is used to achieve the optimum performance from the margarine. These combinations are readily altered as the conditions of the margarine performance changes. Typical combinations are given in Table 11.5.

When cake margarine is whipped together with powdered/granulated sugar the recommended emulsifier blend is a combination of distilled monoglycerides, fully hardened, with either polyglycerol esters or lactic acid esters of mono-diglycerides. This combination ensures excellent cream volume within the cake mix. However, when the margarine is whipped together with syrup sugar or sugar with water to form creams, then unsaturated monoglycerides are recommended to maintain the desired structure of the cream. Typically, a relatively high IV (90–100) provides better performance because it affects both fluidity and emulsion/dispersion stability (O'Brien, 1998). Creams produced with low IV mono- and diglycerides produce tight emulsions, and restrict aeration (Wassell, 2005). Low IV mono- and diglycerides are more suited for cake formulas, and are normally assisted by a co-surfactant to aid other positive effects on final cake quality, as stated previously.

Table 11.5 Shows the type of emulsifier combinations for cake margarine types under different conditions together with approximate dosage guides

Application	Emulsifier combination	Dosage
Cake margarine	Polyglycerol ester + Fully saturated distilled monoglyceride	0.5–1.0% + 0.2–0.5%
	Lactic acid ester + Fully saturated distilled monoglyceride	0.5–1.0% + 0.2–0.5%
	Propylene glycol ester + Fully saturated distilled monoglyceride	0.5–1.0% + 0.2–0.5%
Cream margarine whipped with granulated sugar	Fully saturated distilled monoglyceride + Polyglycerol ester	0.1–0.2% + 0.5–1.0%
	Fully saturated distilled monoglyceride + Lactic acid esters	0.1–0.2% + 0.5–1.0%
	Polyglycerol ester or Lactic acid ester of mono-diglycerides	1.0%
Cake margarine with syrup sugar	Unsaturated distilled monoglyceride	0.5–1.0%

11.7 Puff Pastry Margarine

The requirements for puff pastry margarine are quite different from the cake margarines above. Production of puff pastry involves the basic dough being rolled out and partly covered by a single, thin, flat piece of margarine. The uncovered dough is then folded over the margarine and the whole piece rolled out thinly. This folding and rolling procedure is repeated a number of times until the desired number of laminar layers of alternate dough/margarine is achieved. The whole process is known as lamination. By means of the Scotch method, the margarine is broken or cut into lumps and mixed together in the basic dough. The French method uses a whole piece/block of puff margarine, and this is enveloped into the dough piece unit, then laminated. The English method is where slices of puff margarine are placed over two-thirds of the rolled out rectangular dough piece, and then folded in a fashion which keeps dough/fat layers separate, and then laminated as previously described. Here the main function of the margarine is to separate the layers of dough and produce a pastry with a uniform flaky texture and a high volume. As each layer of margarine must be homogeneous and unbroken, it is extremely important that the margarine can withstand vigorous stretching and rolling, i.e. the margarine structure must be highly plastic. The fat blend used for the margarine must impart the necessary plasticity and typically involves the use of palm oil, tallow, and rearranged lard, where the solid and liquid fat content are balanced to give the plasticity desired over a wide temperature range.

The emulsifiers that are used to stabilise the puff pastry margarine act in stabilising the liquid emulsion by reducing the interfacial tension between the water and the fat phases. However, the emulsifiers also play a role in the crystallisation of the fat during cooling, kneading, and storage processes. All this is optimised towards giving the margarine the required level of plasticity. Enormous processing pressures are typical for puff pastry manufacture, sometimes up to 100 bar pressure. Through optimal processing, emulsifiers help to ensure plasticity by helping to secure and maintain water droplets, and they improve the heat stability of the emulsion during the baking process. The emulsifiers recommended for puff pastry margarine are given in Table 11.6.

As well as the emulsifiers recommended in Table 11.6 addition of lecithin at a dosage of 0.5–0.8% will help to extend plasticity.

Table 11.6 Recommended emulsifier blends and dosages for puff pastry margarine

Emulsifier Blend	Dosage
Monodiglyceride/Polyglycerol ester blend	~1.0%
Fully saturated distilled monoglyceride	~1.0%

11.8 Industrial Fillings

Fillings, in this context, refer to fat-based fillings such as those found sandwiched between biscuits, cakes, snack bars or the classic Swiss roll. The fillings are either added to an already baked product by injection, or are simply spread on the surface. A good filling must be easy to handle, stable—often at room temperature, and possess the fine plastic texture under storage but also melt quickly in the mouth. The fat blend must therefore reflect these demands, with a careful balance between the solid and liquid fat fractions. It must crystallise shortly after depositing, allowing another biscuit say, to be placed on top without the filling squeezing out the side. These fat-based fillings fall into three main categories, standard fat fillings 20–40% fat; aerated filling stable at ambient temperature, 20–40% fat; and milk-based aerated filling, 20–35% fat. Each category has specific emulsifier demands.

The standard fat fillings of 20–40% fat content are the simplest and consist basically of fat and sugar. Their texture can be improved by addition of an emulsifier. Here the use of an unsaturated distilled mono-glyceride is recommended, as previously explained in the cake and cream margarine section. A smoother, more homogeneous filling is achieved that in turn incorporates and retains air.

For the fully aerated filling, which should be stable at ambient temperature with a fat content of 20–40%, other emulsifiers are required. Here, a combination of lactic acid esters of mono- and diglycerides together with citric acid esters of mono- and diglycerides is recommended. The lactic acid esters ease the incorporation and retention of air into the low-fat filling, simultaneously improving stability and stiffness. Reduction in whipping time required is also observed. The citric acid esters enable the integration of the fat phase with the solid/sugar fraction, and serve to give a smooth, easy to handle, homogeneous filling.

Milk-based aerated fillings of 20–35% fat content similarly have air incorporated into them, and can be characterised by their light, fluffy mouthfeel. Due to their higher water content, they are usually stored at refrigerated temperatures and the emulsifier used to obtain a stable emulsion and prevent water separation is an unsaturated distilled mono- and diglyceride together with a lactic acid ester based emulsifier, although this is not enough on its own. The water phase is further stabilised by hydrocolloids, which increase the viscosity and/or bulk to the water phase in addition to imparting stability and firmness to the final filling.

11.9 Reduced- Low-Fat Spreads

As indicated above, reduced-fat and low-fat spreads typically have fat contents of 60 and 40%, respectively. The reduced-fat systems have to some extent been covered in the previous application areas, but the low-fat spread systems are used almost primarily for spreading on bread.

As the fat content is much less than in the systems already discussed, the demands on the emulsifier are greater, such that they must play an increasing role in the stabilisation of the water phase. The pre-conditions for a stable low-fat spread are small water droplets and a stable emulsion. Other components in the system, such as milk proteins, act to give a more open emulsion resulting in improved flavour release; but they also make controlling the water dispersion more difficult, with the consequence of shorter shelf life. The recommendation for which emulsifier to use therefore depends not only on the fat content of the spread product, but also the protein content. Indeed the firmness of the chosen fat blend must also be considered, as must also local water hardness where certain hydrocolloids are selected.

For a 60% fat spread, distilled saturated monoglyceride from a base of either rapeseed or soya at a dosage level of 0.4% will give the necessary stability and droplet size required. For 40% fat spread without protein, 0.5% of distilled unsaturated monoglyceride from vegetable base is recommended, whereas if protein is present, then either 0.5% of rapeseed or soya-based distilled saturated monoglyceride, or a combination of 0.5% of palm based distilled saturated monoglyceride or 0.5% soya based distilled saturated monoglycerides and 0.1–0.2% PGPR is recommended. For 20% fat spreads without protein either 1.0% distilled unsaturated monoglycerides, or a combination of 0.5% distilled unsaturated monoglycerides with 0.4% PGPR is recommended. Finally, for 20% fat spreads with protein, the recommended combination is 0.6% distilled unsaturated monoglycerides with 0.4% PGPR. These combinations are fairly typical, and will of course be optimised according to best practice.

In low-fat spread applications, which have a high water and protein content, polyglycerol polyricinoleate (PGPR) can be used to great effect. It possesses exceptional water binding properties through which it secures the necessary emulsion stability and water dispersion. Under European rules, according to EC directive 95/2/EC, PGPR (E476) is allowed for use in low-fat spread applications with 41% fat or less in a maximum dosage of 0.4%.

For the reduced fat systems that are used for frying, a range of different emulsifiers is suggested such that the emulsion itself can be made to stability levels as those above. Here the water droplet size is vigorously controlled to hinder the spatter that typically plagues this application. The fat content of these systems is more readily termed reduced as it is about 60–70%, but even here good frying results are gained. Going to lower fat contents for frying is not really feasible. The emulsifiers therefore for the 60% fat frying systems are generally combinations. It is difficult for one single emulsifier to cover all the demands alone. Hence, combinations of citric acid esters with saturated distilled monoglycerides, or other vegetable based emulsifiers together with lecithin are generally recommended.

When referring to the reduced and low fat systems generally, it is important to account for texture and control the crystallisation of the fat phase. As has been mentioned above, the stable fat crystal form for desirable mouthfeel texture is the β' form as opposed to the β form, towards which the fat crystals will tend. As said earlier, this tendency can be hindered or indeed prevented, within the products shelf

life by addition of sorbitan tristearate (STS). Due to its irregular shape, the STS prevents the 90° rotation of the fat molecules towards the β form. Typically, STS is added at around 0.5%.

Another problem facing the low-fat systems is the prospect of oiling out, a phenomenon, which is prevented or at least reduced by stabilising the crystal lattice at higher than ambient temperatures. This is achieved by use of a high-melting stabiliser, where the dosage is basically governed by the degree of oil separation to be prevented. Higher oiling out tendency therefore requires a higher dosage of the high-melting stabiliser. Here, a vegetable fat/emulsifier blend is recommended with a dosage level ranging from 1% to 2%.

The water phase of the low-fat systems requires special attention, as the use of emulsifiers themselves is insufficient to achieve the stability required. This is true not just because of the amount of water present, but also the incorporation of proteins, be they skimmed milk proteins (casein) or whey based. The action of the proteins is to form a looser, more open emulsion that improves flavour release. A down side effect is observed, whereby there is reduction of emulsion stability. Hence the need for other stabilisers: hydrocolloids. Much has been made of gelatine in this application due to its very specific melting properties. However, the modern trend has been to find gelatine alternatives and the ones of prime choice are pectin and alginate, used either alone, or in combination.

When controlling the water phase with the hydrocolloids, the aim, indeed the optimum, is to make sure the water phase and the fat phase have a similar viscosity when the low fat spread product is processed. If this is achieved, then a stable, homogeneous low-fat spread product is achieved without water separation (syneresis). Achieving similar viscosity of both water and fat phase is possible by varying the hydrocolloid type and dosage as well as the protein type and dosage together with using a softer fat blend. However, solutions based on the softer fat blend can be problematic in regions where there is inadequate temperature control at higher ambient conditions. This is because the low fat spread must be sufficiently firm to be acceptable and spreadable, and have a good mouthfeel.

11.10 Product Spoilage

Although not directly related to the emulsifiers themselves, shelf life issues regarding spoilage of the margarine or spread product are important to consider. Two types of spoilage occur, that due to microbiological contamination and that due to chemical rancidity, i.e. fat oxidation.

Yeasts, bacteria or moulds are responsible for the microbiological contamination of margarines or low fat products. These species are generally unable to grow in fat and oil systems. Therefore contamination in the margarine type products occurs through growth of these species in the water droplets within and on the product's surface. Microbiological spoilage is influenced by water droplet size, protein content, salt content, and pH.

The smaller the water droplet size, the less attractive the environment for the micro-organisms since less nutrients are available to them. Similarly, the smaller the water droplet size the greater is the proportional chance of more sterile water droplets than actual micro-organisms. Hence, small water droplet size increases the shelf life of the product, and this is a side function of what the emulsifiers are able to do on grounds mainly of texture and stability. By small, it is meant that the average droplet size in margarine is 4–5 μ with a range from 1 to 20 μ . When the droplet size is less than 10 μ , it is doubtful that these restrictive environments will allow micro-organism growth (Delamarre and Batt, 1999). In reality good manufacturing practice (GMP) must come into play, because the margarine and spreads (water-in-oil) industry is generally regarded as low risk, sometimes larger size droplets are found because of the acceptable trade-off with required flavour release.

Protein will act as nutrients for the micro-organisms unless salt and pH levels are addressed. For the same margarine with 16% water, addition of 1% salt overall will inhibit the growth of many micro-organisms whereas addition of 2% salt will prohibit almost all. It should be noted that addition of low levels of salt, around 0.1–0.2% overall may actually enhance the growth of the micro-organisms. It is worth noting that it is the salt content in the water phase that is important, and thus as a rough guide, a margarine with 16% water and 1% salt overall results in a 6% salt content in the water phase alone.

pH is similarly an issue, and generally low pH values inhibit more micro-organisms than higher pH values, i.e. around pH 4.0–4.5 micro-organism growth is retarded. Higher pH values of 5.5–6.0 enhance growth. Adherence to GMP will avoid pathogenic contamination.

Chemical rancidity or oxidation occurs in the fat phase and is caused by a reaction between the fat and oxygen. The reaction takes place at the double bonds of the fatty acids, forming peroxides, aldehydes and ketones etc. The composition of the water phase is important since the oxidation process begins at the interface between the water and fat phases. Once started, oxidation proceeds quickly. Factors influencing the oxidation rate include the composition of the fat blend, oxygen availability, metal ions, salt, pH, water droplet size, and light.

The more double bonds present in a fatty acid the quicker it will oxidise. Stearic acid is 10 times more stable towards oxidation than oleic acid; 100 times more stable than linoleic acid, and 1000 times more stable than linolenic acid when kept at the same temperature. Also the greater the concentration of liquid oil in the fat blend the more prone it will be to oxidation during its shelf life. Generally the following liquid oils oxidise most easily in the following order of diminution: Safflower oil, soya bean oil, rape-seed oil, sunflower oil, corn oil, cotton seed oil, and ground nut oil.

Atmospheric oxygen should be limited in its contact with the oils, often practically achieved by blanketing the processing tanks with nitrogen. Metal ions can also increase the tendency for oxidation, copper ions in particular and therefore any piping and tubing in margarine plants should not be made of copper or copper alloys. The use of sequestrants in the water phase, and water softening capability will also help to minimise effects of oxidation. Salt will help to catalyse the oxidation process, such that more salt is equivalent with faster oxidation. Similarly low

pH values will aid the oxidation steps (4.0–4.5), and higher values (5.5–6.0) will reduce the tendency. Hence, large quantities of salt should not be used at low pH. Small water droplets lead to a large interfacial surface area between the water phase and the fat phase increasing the rate of oxidation onset.

As can be seen from the three latter examples of salt, pH and water droplet size, they are in direct contrast to the conditions demanded to stop micro-organism attacks!

Light, especially UV will strongly catalyse the oxidation process, and of course the product should be stored under cool, refrigerated conditions.

Given that the contamination by micro-organisms and the texture and mouthfeel qualities demanded of the margarine and spread products are at odds with the conditions required to minimise oxidation, the oxidative problems are solved by adding in a range of dedicated antioxidant materials. These may be the well known phenolic antioxidants of BHA, and BHT etc. but these are gradually being replaced by vitamin based products such as ascorbyl palmitate or even natural extracts such as rosemary extract.

11.11 Summary

The traditional margarine of 80% fat content is a very stable product and does not require a great deal of emulsifiers to hold the structure demanded; be they mono- or diglycerides, lecithin or citric or lactic acid esters of the monoglycerides over and above any proteins that might also be present. Performance of industrial margarines can depend very much on the emulsifier system. As the fat content is reduced to 60% and below, the presence of emulsifiers is a pre-requisite to hold the emulsion stable, homogenous and still give the product the functionality the application demands. At fat contents of 40% other ingredients (hydrocolloids) are required to further stabilise the water phase and these work in cooperation with the emulsifiers. When dealing with these low fat content products it is important to understand the nature of the application of the product such that the correct emulsifiers can be chosen for the job in hand.

To maintain a decent shelf life of the product antioxidants are usually added to hinder the rancidity that will naturally occur. Micro-organism contamination is usually dealt with by making the structure of the margarine and spreads unattractive for them. These conditions happen to coincide with the desired conditions for optimal functionality, mouthfeel, and textural properties of the product.

References

- Berger, K.G., and Idris, N.A. (2005). Formulation of zero-*trans* acid shortenings and margarines and other food fats with products of the oil palm, *J. Am. Oil Chem. Soc.* 82: 775–782.
- Bot, A., Flöter, E., Lammers, J.G., and Pelan, E. (2003). Controlling the texture of spreads. in *Texture in Foods* Vol.1. Ed. McKenna, B.M. pp 350–372.
- Britannia Food Ingredients Ltd. (2000). <http://www.britanniafood.com>

- Chrysam, M.M. (1996) Margarines and spreads. in *Bailey's Industrial Oil and Fat Products, 5th Edition. Vol. 3 Edible Oil and Fat Products and Application Technology*. Ed. Hui, Y.H. pp 65–114.
- Delamarre, S., and Batt C.A. (1999). *Food Microbiol.* 16, 327–333.
- Flack, E. (1997). Margarines and spreads. in *Food Emulsifiers and Their Applications*. Eds. Hasenhuettl, G.L., and Hartel, R.W. pp 270–274.
- Hernqvist, L. (1988). *Fat Science Technology*, pp 451–454.
- Hoerr, C.W. (1960). Morphology of fats, oils shortening, *J. Am. Oil Chem. Soc.* 37: 539–546.
- Klemann L., (2004). Kraft Foods Inc., INFORM, April, 231
- Madsen, J. (2003). Fat Crystallography—A Review. Technical Paper TP 1504–2e, Dansico A/S.
- Madsen, J., and Als, G. (1968). Sandiness in table margarine and the influence of various blends of tri-glycerides and emulsifiers thereof. ISF. Rotterdam, pp 11–17.
- Marangoni, A.G. (2005). *Fat Crystal Networks*. Marcel Dekker, New York.
- O'Brien, R D. (1998). *Fats & Oils: Formulating and Processing for Applications*, Technomic, Lancaster, P.A. p 361.
- Siew, W L., (2002). Understanding the interactions of diacylglycerols with oils for better product performance, *Palm Oil Dev.* (MPOB) 36: 6–12.
- Tamstorf, S., Jønsson, T., and Krog, N (1986). The role of fats and emulsifiers. in *Baked Products: Chemistry and physics of Baking Materials, Processes and Products*, ed. J.M.V. Blanshard. London: RSC, 75–88.
- Timms, R. (1991). Crystallisation of Fats, *Chemistry & Industry (SCI)*, May 20th, 342–344.
- van Soest, T.C., de Jong, S., and Roijers, E.C. (1990). *J. Am. Oil Chem. Soc.* vol 67, pp 415.
- Wassell, P. (2005). Low trans shortenings 96th AOCS Annual Meeting + EXPO, 1–4th May 2005, Salt Lake City, Utah, USA.
- Wassell, P., and Young, N.W.G. (2007). Food Applications of *trans* fatty acid substitutes. *International Journal of Food Science and Technology* 42 (5): 503–517.
- Yap, P.H., deMan, J. M., and deMan, L. (1989). Polymorphic stability of hydrogenated canola oil as affected by addition of palm oil, *J. Am. Oil Chem. Soc.* 66 (12): 1784–1791.

Chapter 12

Application of Emulsifiers to Reduce Fat and Enhance Nutritional Quality

Matt Golding and Eddie Pelan

12.1 Introduction

At a time when both malnutrition and obesity are increasingly becoming global issues, it is perhaps unsurprising that health, nutrition and weight management are the current main consumer trends within the food industry. As a consequence of these trends, innovation within this sector is being driven by the need to reduce perceived 'bad' ingredients: (saturated/trans) fat, salt and sugar, whilst attempting at the same time to fortify foods with nutritional actives, such as minerals, vitamins and antioxidants, all in support of a healthier lifestyle. The market for reduced fat/reduced calorie products is highly lucrative. In the UK alone, this market segment was worth GBP 1,875 million in 2004, up from GBP 1,372 million in 2000. In 2005, sales are expected to reach GBP 1,975 million. However it should be stated that in moving towards healthier, more nutritious products, the demanding consumer still expects that the quality of the particular food in question is not compromised in terms of overall sensory performance (appearance, texture, flavour).

The use of emulsifiers as a structuring tool for fat reduction and/or nutritional enhancement is exemplified in many food product systems. Some examples of emulsifier applications for fat reduction, such as fat structuring in homogenised creams and ice creams, are not necessarily new innovations. However, there are also more recent developments, such as the use of emulsifier mesophase technology which have found application in products such as zero fat ice creams and spreads.

This chapter reviews some of these diverse applications, both old and new, aiming to show the versatility of emulsifiers when in food formulations for the purpose of fat reduction and nutritional enhancement. The term emulsifier in this instance refers specifically to (non-protein) molecules derived from fatty acids, such as lecithins, monoglycerides and their derivatives. It aims to examine the contribution of emulsifiers in improving product structural design as a means of reducing or eliminating (saturated) fat from food systems, whilst attempting to maintain the quality of the food product. It also aims to explore the use of emulsifiers as delivery mechanisms for nutritional enhancement of foods.

12.2 Homogenised Dairy and Non-Dairy Whipping Creams

Homogenised whipping creams have been produced commercially for over four decades. They are specifically designed to imitate the organoleptic properties of non-homogenised dairy creams for the main application properties of cooking, baking, pouring and whipping. In the particular case of whipping cream formulations, some of the main advantages presented by homogenised dairy and non-dairy creams compared to non-homogenised dairy analogues are improved shelf-life (through UHT treatment), more robust whipping properties (less chance of buttering), and especially reduced fat level (reduced from typically 30–40% in dairy systems to <20% in non-dairy systems). Whilst the natural composition of dairy cream lends itself to providing good whipping properties above a certain fat level, the challenge with homogenised dairy and non-dairy whipping creams is to design an emulsion systems with comparable whipping and sensory performance at these greatly reduced fat concentrations.

Dairy whipping cream is seen as an indulgent product, understandable considering the relatively high fat content. Homogenised non-dairy and dairy creams aim to target this high fat content offering lower calorie alternatives. A comparison between the caloric content of some dairy and non-dairy whipping creams is given in Fig. 12.1.

Whipping creams are aerated emulsions with overruns typically ranging from 100–300%. Whipped creams should also possess good stand-up properties (i.e. the foam structure should be self-supporting and not flow). Although foam lifetime of whipped creams is not intended to be more than a few days, there should not be any

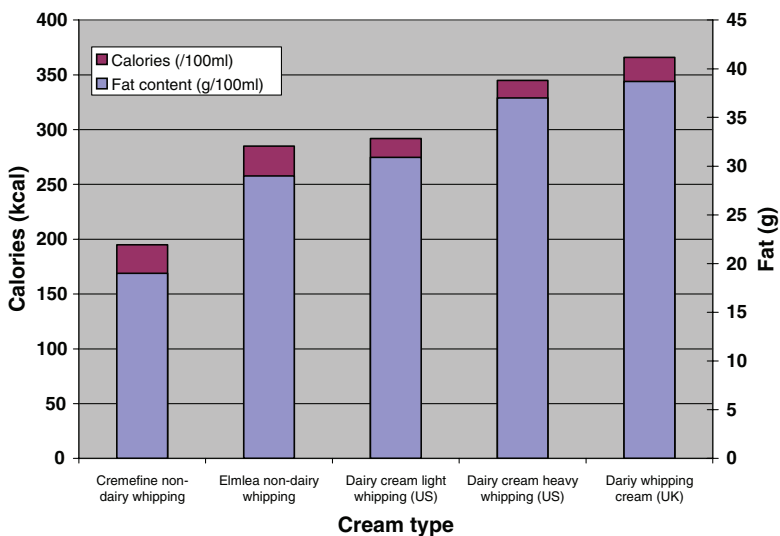

Fig. 12.1 Examples of caloric and fat contents of some non-dairy and dairy cream samples

visible ripening of the foam structure during the lifetime of the product. The mechanism by which a stable foam structure can be generated by whipping of dairy cream has been of considerable academic and commercial interest for a number of years (Flack, 1985; Bruhn and Bruhn, 1988; Goff, 1997; Leser and Michel, 1999; van Aken, 2001), and is discussed at greater length in chapter 7 of this book.

In order to demonstrate how the use of emulsifiers can contribute to the development of a low fat whipping cream, we need to review the mechanism by which whipped structures can be prepared. An elegant model for the development of the whipped cream structure is provided by Besner and Kessler (1998) who described the mechanism as occurring in three stages during the whipping process (Fig. 12.2):

- a) Protein adsorption at the air water interface to provide initial foam stability. Milk proteins are generally present in both dairy and non-dairy cream formulations. In the specific case of dairy cream, most of the casein and whey protein is present in the continuous phase of the emulsion is not adsorbed at the oil-water interface (Needs and Huitson, 1991), forming a foam. At this stage, overrun is still low and the cream possesses no stand-up properties.
- b) Adsorption of fat globules to the air-water interface. During the whipping process, the weak milk fat globule membrane allows fat droplets to adsorb to the surface of protein stabilised air-bubbles. This is possibly due to the rupture of the MFGM during the shearing process, which allows wetting and partial spreading of fat droplets on contact with the bubble surfaces. The formation of the globule-coated interface is more effective at preventing bubble coalescence than a milk-protein stabilised interface.
- c) Fat globule adsorption to the bubble surfaces facilitates globule aggregation in the continuous phase. Droplet aggregation and subsequent formation of a fat globule network is required to prevent drainage of the stabilised foams and provide body/stand-up to the whipped cream. The shearing process leads to partial coalescence of fat droplets, an irreversible aggregation process in which fat wetting between two or more droplets can take place (Boode and Walstra, 1993;

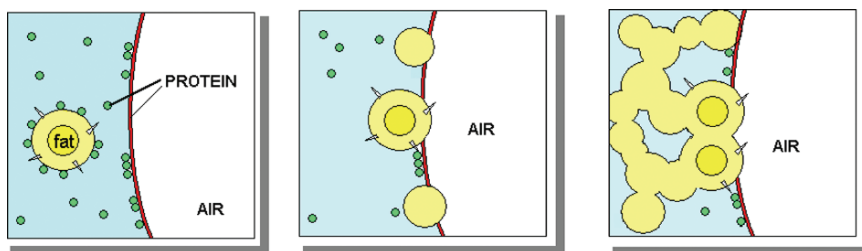

Fig. 12.2 Highly schematic representation of structure development in dairy whipping creams. **a** Initial stabilisation of air phase by adsorbed proteins. **b** Secondary stabilisation of air phase by adsorption of fat globules. **c** Development of partially coalesced fat network in the continuous phase

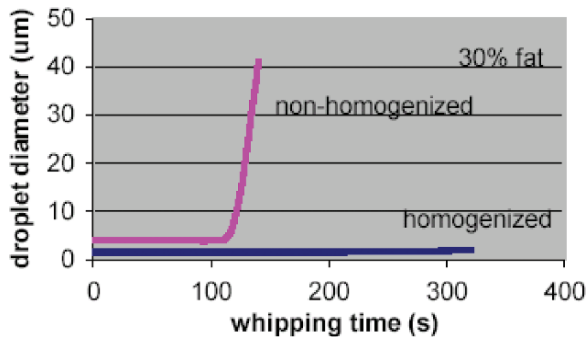

Fig. 12.3 Change in emulsion droplet diameter as a function of whipping time for 30% homogenised and non-homogenised whipping creams (Adapted from Besner H, Kessler HG, *Milchwissenschaft* 53 (12): 682–686 1998)

Table 12.1 Typical non-dairy whipped cream composition

Composition	Amount
Fat	20–30%
MSNF	3–6%
Added sugars	5%
Stabilisers	0.05–0.2%
Emulsifiers	0.05–0.6%

Vanapalli and Coupland, 2001). The presence of solid fat within the emulsion prevents full coalescence from taking place, so droplets partially maintain their integrity, hence the name (Boode et al., 1993) (Fig. 12.3)

A good whipped cream structure requires both fat globule adsorption to the surface of the bubbles in the foam, and the generation of an aggregated fat network in the bulk. This structure has been visualised by a number of authors (Buchheim, 1991; Brooker, 1993) and is described in more detail in chapter 7.

Non-dairy whipping creams and homogenised low-fat dairy whipping creams are formulated and processed to provide structuring according to this particular mechanism of whipping. A typical non-dairy whipping cream composition is given in Table 12.1.

For non-dairy creams butterfat is replaced by vegetable fat(s). These are commonly high lauric fats such as coconut or palm kernel oil, which provide the required solid fat content at whipping temperatures, but which melt at in-mouth temperatures (thus providing the desired oral response). As stated previously, non-dairy whipping creams can provide whipped structures with acceptable organoleptic properties at almost half the fat content of a conventional dairy whipping cream.

The milk solids non fat component (MSNF) is usually either skimmed or butter milk powder, which is added, in part, to provide a dairy flavour to the cream.

However, the MSNF also contains the milk proteins: casein and whey. Unlike dairy creams, non-dairy creams require a homogenisation step to form a stable emulsion. Milk proteins are important to the formulation, as they provide the initial stability to the emulsion on homogenisation. Droplet size for homogenised dairy and non-dairy creams is typically 1 μm or less, which is at least a quarter of that usually encountered for non-homogenised dairy creams. The reduction in droplet size also corresponds to a significant increase in specific fat surface area, which may account for the fact that less fat is required to provide a stable foam structure in the case of homogenised cream.

Protein is essential to provide a stable emulsion during preparation of the cream. However, the adsorbed protein layer prevents adsorption of globules to the air-water interface, and provides effective stability against partial coalescence during the whipping process. In order to achieve the functionality required to generate appropriate whipped structures, emulsifiers are included in the formulation. These have little or no effect on the stabilisation of the emulsion during homogenisation during processing, since at the temperatures applied during homogenisation (typically 80°C) there is less of a difference in interfacial tension between the emulsifier and the protein. However on cooling, an interfacial tension gradient opens between the protein and the emulsifier, with the result that the emulsifier displaces the protein from the interface. Displacement of adsorbed protein and replacement by emulsifier interfacial layers has a significant impact on the stability and functional properties of emulsion systems. Consequently, the displacement of protein by emulsifiers from interfaces has been the subject of considerable academic attention in recent years (Segall and Goff, 1999; Stanley et al., 1996; Tual et al., 2005, 2006).

In the particular case of non-dairy whipping creams, addition of emulsifiers has been shown to facilitate adsorption of fat globules to the air-water interface during whipping. This appears to be a common effect to most emulsifier systems, and therefore most emulsifier types will contribute to the interfacial stabilisation of the foam. There is some speculation as to why the presence of an emulsifier layer on the droplet interface should promote adsorption to the bubble surface. However, it may be related to the fact that regions on the fat globule surface where displacement has taken place are more interfacially-active than the protein layers adsorbed to the bubble surface during the beginning of the whipping process.

Consequently, during collisions with the bubble surfaces during shearing, fat globules become preferentially adsorbed to the air-water interface. Increasing emulsifier concentration will result in higher surface coverage of the emulsifier at the droplet interface and will therefore increasing the potential for a droplet to adsorb to a bubble surface during whipping. This particular aspect of the whipping process is used to great effect in the stabilisation of aerosol creams. Here, emulsifiers are used specifically to promote the adsorption of fat globules to the air-water interface where they provide excellent stability to the foam. Fat structuring in the bulk phase is not necessary since foam structure is derived from the high overrun produced by the aerosol.

For homogenised whipping creams addition of emulsifiers also promotes fat structuring during the whipping process, which is essential for providing rigidity to

the cream. Type and concentration of emulsifier can have a significant impact on emulsion structuring properties. In short, it can be stated that displacement of protein from the oil-water interface by particular emulsifiers can create active sites on the droplet surface which can result in droplet aggregation under shear. The nature of the droplet aggregation is understood to be dependent on the type and concentration of the emulsifier systems used (Krog and Larsson, 1992).

Whilst it is certainly true that partial coalescence does take place for particular formulations of homogenised whipping creams, it is not necessarily the only type of aggregation observed during the whipping process. Under certain formulation conditions it is possible to design emulsions that form network structures through interfacial aggregation, as opposed to partial coalescence. In these circumstances, there is no rupturing of the interfacial layer. Both partial coalescence and interfacial aggregation result in the build-up of a fat network (similar to the processes taking place for dairy whipping cream), which increases the stand-up properties of the cream.

Whilst most food grade emulsifiers have the ability to displace protein from the interface of emulsion droplets, it is important to note that the composition and nature of the interface can vary significantly according to the specific emulsifier or emulsifiers used. Even emulsifiers with similar structures and HLB values can provide very different interfacial (and thus whipping) properties. As such, there are no definitive guidelines for which emulsifiers can provide acceptable whipping properties, although it is understood that particular emulsifiers are more effective at promoting fat adsorption to the air interface, whilst others are more effective at structuring the emulsion under shear. Often a combination of emulsifiers provides the most effective whipping properties in terms of aeration and fat structuring.

The composition of the oil-water interface is the main determining factor for how the emulsion behaves on whipping. Choosing the most appropriate emulsifier system for a non-dairy cream formulation and optimising its concentration and processing conditions will determine the functionality of the cream. Optimising emulsion droplet functionality is critical in determining whether a cream will be stable under storage conditions yet has acceptable whipping properties when aerated.

The current challenges facing the non-dairy creams industry are the ability to produce cream with acceptable structuring properties whilst continuing to lower the fat content of the cream. Whipping creams with less than 20% fat are now commercially available. Whilst there are a number of other structuring routes which can be used to provide whipped structures at even lower fat levels, the further reduction in fat will eventually lead to an unacceptable loss of sensory performance.

Additionally, removal of saturated triglycerides from formulations and replacing them with unsaturated triglycerides, whilst maintaining the textural and flavour properties associated with whipped cream is desired. Solid fat is a particular requirement for providing acceptable stand-up properties of whipped creams, both dairy and non-dairy. Manufacturing whipping creams with high levels of unsaturated oils which can be aerated and possess good structure is not a trivial exercise.

12.3 Reduced and Low Fat Ice Cream

Depending on which historical perspective is correct, ice cream has been consumed as an indulgent treat for between 300 and 700 years. At its most basic, ice cream can be described as an aerated frozen foam containing milk, cream, sugar with flavouring added (still most commonly vanilla). However, due to the consistent popularity of ice cream as a foodstuff (14.4 billion litres were sold globally in 2001), there are now many choices in today's ice cream market in order to suit a wide variety of consumer tastes. In order to provide some explanation as to the numerous ice cream formats available for purchase, the US FDA has set up standards of identity to characterise ice creams according to formulation. Whilst these are not necessarily applied globally, they can provide useful information regarding consumer trends in the consumption of ice cream. A summary of the FDA classification of ice cream is as follows:

- **Ice cream**, an aerated, frozen food made from a mixture of dairy products, containing at least 10% (milk) fat.

Superpremium ice cream tends to have very low overrun and high fat content, and the manufacturer uses the best quality ingredients.

Premium ice cream tends to have low overrun and higher fat content than regular ice cream, and the manufacturer uses higher quality ingredients.

Regular ice cream meets the overrun required for the federal ice cream standard.

Economy ice cream meets required overrun and generally sells for a lower price than regular ice cream.

- **Reduced fat** ice cream contains at least 25% less total fat than the referenced product (either an average of leading brands, or the company's own brand.)
- **Light** ice cream contains at least 50% less total fat or 33% fewer calories than the referenced product (the average of leading regional or national brands.)
- **Low-fat** ice cream contains a maximum of 3 g of total fat per serving (125 ml).
- **Non-fat** ice cream contains less than 0.5 g of total fat per serving.

The current consumer trends within ice cream present something of a paradox. Whilst consumers are generally becoming more health conscious about what they eat, the highest market segments in ice cream at the moment are the premium and super-premium brands of ice cream, which can contain anything between 10 and 20% fat (Fig. 12.4). At these high fat levels (usually in the absence of added emulsifiers), there is a dominant contribution of the fat phase to the sensory properties of the ice cream (creamy texture and flavour) as well as to the meltdown stability. Unfortunately, there is also a significant contribution to the caloric content as well!

To a degree this is accepted: ice cream has always been perceived as an indulgent product – with fat level as an indicator as to the quality of the product. Consequently, lowering of the fat content within the formulation is often accompanied by a perceived reduction in sensory quality of the ice cream. The relationship between calorific

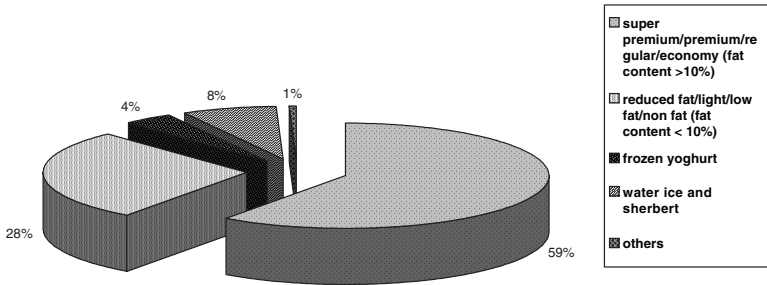

Fig. 12.4 Market segments for 2004 US Ice Cream market showing, amongst others, market share for high (>10%) and low (<10%) fat ice cream products. US Ice Cream market was estimated at 1.6 billion US gallons in 2004

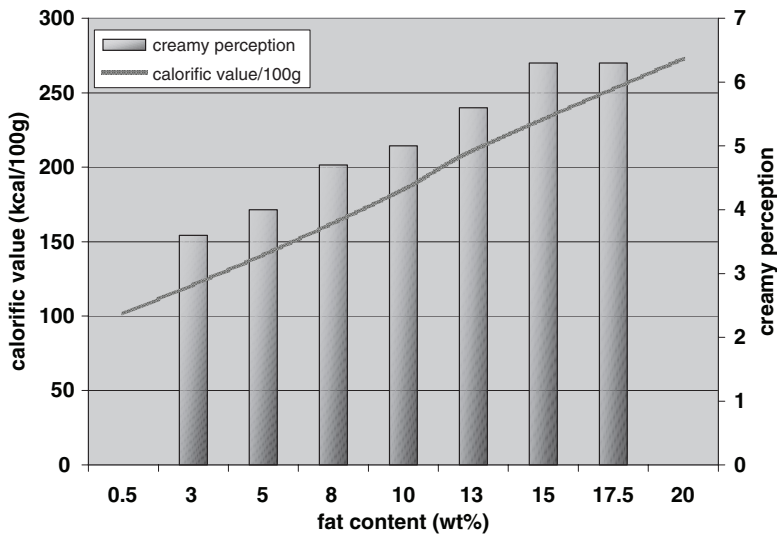

Fig. 12.5 Graph showing the relationship between fat content in ice cream, calorific content and perceived creamy texture. Ice creams were consistent in formulation and did not contain emulsifiers

content, as supplied by fat, and the perceived creaminess of the ice cream (in the absence of emulsifiers) is given in Fig. 12.5. However, it is possible to formulate ice creams with a lower fat content in which the sensory properties of the ice cream are not compromised by the reduction in fat.

One route by which the quality of lower fat ice creams can be improved is through the inclusion of low concentrations (0.1–0.5%) of emulsifiers to the ice cream mix. The use of emulsifiers in ice cream formulations is not particularly new, and its earliest application dates back to the 1940s. As with whipping creams, emulsifiers are added to improve the functionality of the fat, such that the fat becomes an

active component in the development of the ice cream structure. This can lead to improved product attributes, such as dryness upon extrusion, improved air phase stability, improved meltdown resistance and improved sensory performance of the ice cream, especially for lower fat formulations.

A typical ice cream mix is given in Table 12.2 below.

Processing of ice cream requires the mix to be pasteurised, homogenised and aged prior to freezing. Prior to homogenisation, water soluble ingredients such as stabilisers, sugars and proteins are dispersed in the aqueous phase. Any oil soluble components are dispersed in the oil phase before the two phases are mixed. Emulsifiers used in the ice cream industry are limited by legislation and are predominantly monoglycerides, and to a lesser extent polysorbates. Monoglycerides, being of low HLB are generally dispersed in the oil phase, whilst the polysorbates being of higher HLB are placed in the aqueous phase.

After homogenisation and ageing the mix is transferred to the ice cream freezer. An ice cream freezer is essentially a scraped surface heat exchanger, operating at $-20\text{ }^{\circ}\text{C}$ into which air is channelled at a pressure of 2 bar. The low temperatures on the surface of the heat exchanger barrel form ice crystals, which are scraped into the ice cream mix. In addition, the high shear forces applied within the freezer assists in aeration of the ice cream. This combination of high shear and low temperature creates the frozen foam ice cream microstructure. The ice cream is then extruded from the freezer before being hardened to at least $-30\text{ }^{\circ}\text{C}$. Storage of ice cream is generally maintained at $-18\text{ }^{\circ}\text{C}$, although some formulations are designed to be stored at temperatures as warm as $-10\text{ }^{\circ}\text{C}$. Volume fractions of the various phases are given in Table 12.3 for different ice cream formats, whilst the distribution

Table 12.2 Ingredient breakdown of a typical regular ice-cream

Ingredient	Amount (wt%)
Fat	5–15
Milk protein	4–5
Lactose	5–7
Other sugars	12–16
Stabilisers	0–0.5
Emulsifiers	0–0.5
Total solids	28–40
Water	60–72

Table 12.3 Typical phase volumes of ice cream components

Phase	Low fat ice cream (%)	Regular ice cream (%)	Premium ice cream (%)
Fat	1	5	10
Air	48	50	35
Ice	31	30	25
Matrix	20	15	30

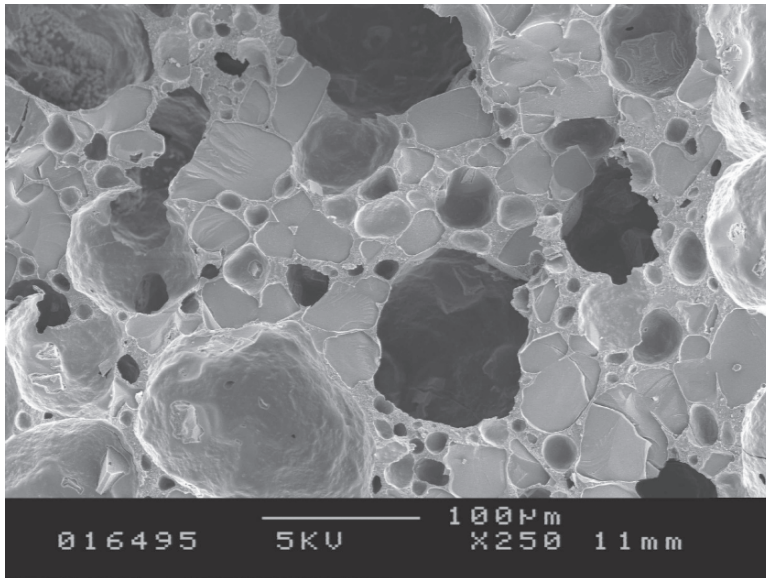

Fig. 12.6 Scanning electron micrograph of ice cream microstructure showing air bubbles, ice crystals and surrounding matrix

of these phases in a typical ice cream microstructure is shown by scanning electron microscopy in Fig. 12.6.

The mechanism by which addition of emulsifiers can influence the microstructural properties is in some respects similar to the effects observed for homogenised whipping creams. As with whipping creams, emulsifiers are added in order to displace protein from the interface of the fat droplets. This takes place during the ageing process after homogenisation. The presence of the emulsifier on the surface of the emulsion droplets facilitates the adsorption of the droplets to the air-water interface during freezing (again the analogy with whipping cream systems can be drawn, since droplets stabilised purely by protein do not undergo adsorption to the surface of bubbles).

Several studies have been carried out to better understand the mechanism by which fat globules containing emulsifiers can adhere to the air-water interface. Whilst the exact mechanism is still the subject of some speculation, it has been recently shown by Zhang and Goff (2005) that the process is sensitive to both the type and concentration of both emulsifier and protein present during the freezing process. In the case of the emulsifier, this is in part influenced by the efficacy by which specific emulsifiers can displace protein from the interface – the more droplet surface coverage by the emulsifier, the greater the potential for adsorption to the surface of a bubble.

Pelan et al. (1997) showed that displacement from the interface varied according to the emulsifier used (Fig. 12.7), and that for the commonly used ice cream emulsifiers, displacement increased in the order:

Saturated monoglycerides < unsaturated monoglycerides < polysorbates

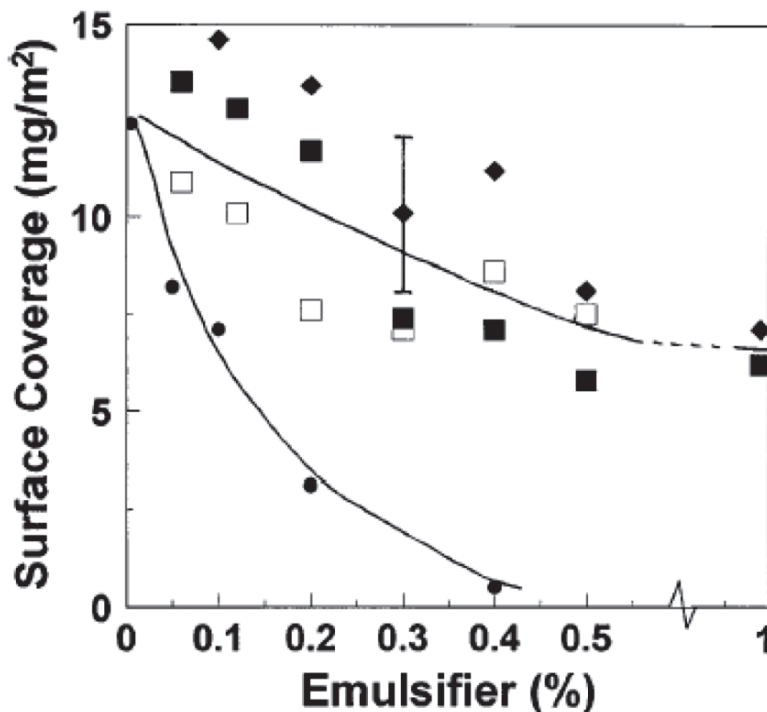

Fig. 12.7 Change in protein loading for ice cream mixes (12% fat, 13% SMP, 15% sucrose) as a function of emulsifier type and concentration. • Tween 60; □ Unsaturated monoglyceride; ■ Saturated monoglycerides; ♦ Glycerol monopalmitate

Differences in displacement between the two types of monoglyceride have in the past been attributed to the structural arrangement of the two emulsifiers at the oil-water interface. However, it may also be due to the fact that saturated monoglycerides are able to nucleate fat crystals on cooling and may therefore become trapped within the bulk of the oil droplet, rather than adsorbing to the interface. Unsaturated monoglycerides have a lower melting temperature than saturated monoglycerides and do not tend to act as nucleators. The fact that emulsion droplets containing unsaturated emulsifiers crystallise at a slower rate than those containing saturated emulsifiers may allow the unsaturated emulsifiers longer to adsorb to the oil-water interface, thereby displacing more protein at equivalent concentrations. Polysorbates are even more effective, since they are water-soluble and adsorb to the oil-water interface independently of the internal state of the oil droplets.

The ability for oil droplets containing emulsifiers to adsorb to the air-water interface has been shown to reduce bubble size during processing and improve bubble stability on storage (e.g. Fig. 12.8 for zero fat ice cream). As with whipped cream systems this is attributed to a Pickering type stabilisation mechanism, which

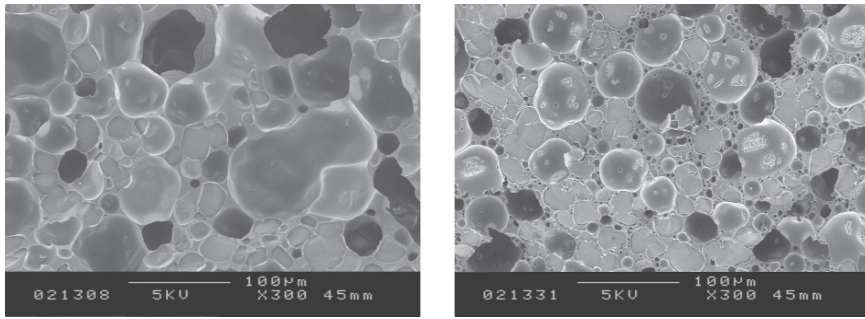

Fig. 12.8 Scanning electron micrographs of zero fat ice creams. In the left hand image the air phase is stabilised purely by milk proteins present in the formulation. In the right hand image, 0.5% saturated monoglyceride has been added to the formulation prior to freezing

prevents coalescence from taking place. Improvement to the fineness of structure and the stability of the air phase are partly responsible for the improved textural attributes of ice cream containing emulsifiers compared to those without. Certainly addition of emulsifiers and the adsorption of fat to the air interface helps inhibit loss of quality through air phase coarsening as a result of temperature cycling.

Inclusion of emulsifiers in the formulation also helps to promote structuring of the fat through partial coalescence, which takes place during the freezing process. Again, the displacement of protein from the oil-water interface weakens the fat droplets. Consequently, droplet collisions driven by the high shear forces in the ice cream freezer allow penetration of droplet interfaces by fat crystals leading to partial coalescence. Again, there are differences between emulsifier types in terms of the amount of aggregated fat generated in the freezer such that, for equivalent concentrations:

polysorbate 60 > unsaturated monoglyceride > saturated monoglyceride

Again, this is in part due to the relative amount of protein displaced by each type of emulsifier at the oil-water interface. However, in the specific case of saturated monoglycerides there is an optimum emulsifier concentration at which maximum fat aggregation can be achieved. If the saturated emulsifier level increases too much, droplets become more stable to aggregation. This is possibly due to the formation of a crystalline emulsifier layer on the surface of the droplets which is thick enough to prevent fat penetration and wetting from taking place.

Whilst fat aggregation is unlikely to lead to the formation of extended fat networks in the same way as whipping cream (due to the lower fat content and presence of ice which disrupts the formation of network structures), localised fat structure formation does improve the meltdown resistance of ice cream. In this case, it is likely that small aggregates of fat inhibit drainage of liquid from the foam structure as the ice melts, holding the foam together for longer.

Partial coalescence has been an accepted model for emulsifier-facilitated fat structuring in ice cream for many years now. However, it has been recently been demonstrated that addition of emulsifiers can lead to other forms of fat droplet

functionality which can provide additional benefits in terms of quality improvements for reduced and low fat ice cream.

Continued understanding of how emulsifiers add functionality to ice cream systems is necessary if the ice cream industry is to follow in the current trend of health and vitality. There is a constant need to improve the quality of low fat systems, and new challenges such as the replacement of saturated fat in formulations will require development of new approaches for how emulsifiers can continue to contribute to the improved structuring of ice creams.

12.4 Zero Fat Ice Cream

The use of saturated monoglyceride emulsifiers has also been shown to provide a specific role in improving the sensorial attributes of ice cream systems in the absence of fat. Zero fat ice cream is something of a niche market. Whilst it might be considered desirable that the overall calorific content of the ice cream is greatly reduced relative to ice cream containing fat, there is unfortunately a corresponding significant drop in product quality which is generally not acceptable for most consumers.

There are two potential routes for improving the sensory properties of zero fat ice cream. The first route uses direct replacement of fat with a non-fat substitute. Fat mimetics, such as microparticulated proteins, can provide limited sensory improvements, but these are expensive and quality enhancement is not particularly noticeable.

An alternative route is provide sensory benefits through optimisation of the microstructure of the ice cream. It is known that ice cream quality is as much dependent on optimising microstructure, as it is about using high quality ingredients. It has been shown that even with the removal of fat from the composition, there are alternative, indirect formulation routes for improving the microstructure, and thus the organoleptic properties of the ice cream.

One particular formulation route that has been patented by Unilever and is currently used in zero fat formulations is the inclusion of a small amount of saturated monoglyceride into the ice cream mix. Although monoglyceride is classified as a fat/lipid on ingredients lists, the amounts used (typically 0.1–0.5%) are within legislation requirements for the ice cream to be labelled as zero fat.

The addition of monoglyceride in a fat-free ice cream mix has been shown to result in the formation of a considerably finer air phase structure compared with protein alone. Figure 12.8 compares micrographs of zero fat ice creams containing no added monoglyceride or 0.5% added saturated monoglyceride. The protein stabilised air phase shows bubbles typically 100 μm or larger, with some signs of coalescence also having taken place. In comparison, the ice cream containing the added emulsifier shows a bimodal distribution of stable air bubbles with a larger phase of typically 50 μm or less, and a high number of very small bubbles of <10 μm .

The observed bimodal distribution is suggestive that partial disproportion has taken place. The fact that bubbles of <10 μm can still be observed implies that this smaller

fraction is resistant to complete disproportionation. These small, stable air bubbles are understood to provide a positive contribution to the organoleptic properties of the ice cream. They are stable melting at ambient temperatures, and may retain stability in the mouth, giving the perception of enhanced creaminess and reduced iciness.

Figure 12.8 indicates that the inclusion of a low concentration of monoglyceride can greatly improve the stability of the aerated structure within ice cream. Saturated monoglycerides display particular mesophase behaviour in aqueous media. At temperatures below the Krafft point, and for low concentrations they form β -crystals in water which do not have foaming capacity. However, in ice cream mixes the monoglyceride forms surface-active particulates. This is understood to be due to the formation of milk protein-monoglyceride liposome structures as a result of the homogenisation process. These are able to adsorb to the air-water interface during the freezing process. These particulates are able to provide considerably greater surface elasticity to the bubbles than protein alone (Fig. 12.9), providing effective resistance to coalescence and preventing complete disproportionation from taking place.

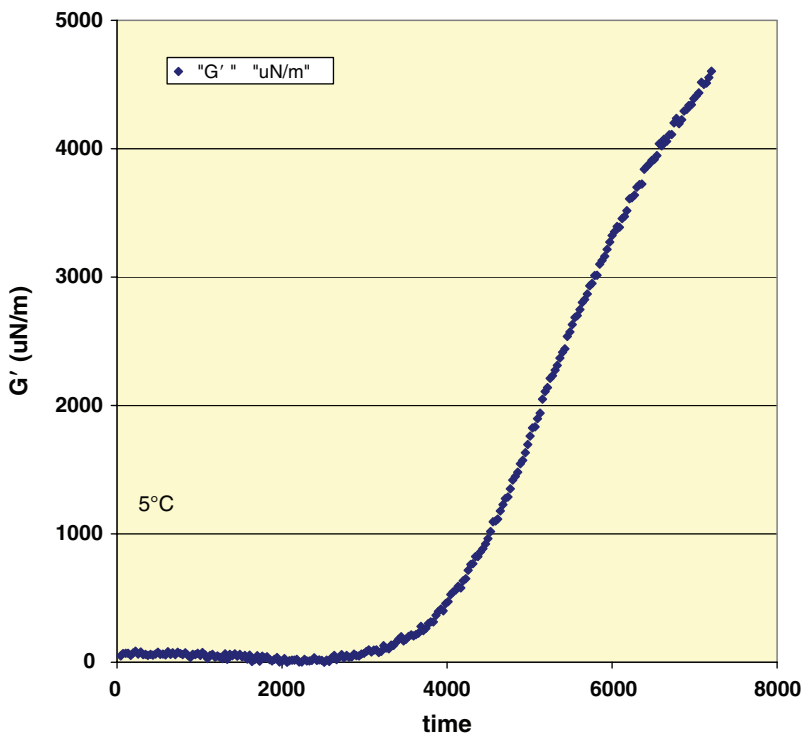

Fig. 12.9 Surface shear rheology (Camtel CIR-100 rheometer) of homogenised mixture of 2.5% sodium caseinate and 0.1% saturated monoglyceride at 5 °C (torque = 10,000 μ rad, frequency = 3 Hz)

Saturated monoglycerides appear to be the most effective emulsifier for improving the stability of the air phase in zero fat ice cream. Unsaturated monoglycerides, for example, can also form particulates in the presence of milk proteins. These are known as cubosomes. However, it has been shown that whilst these are also surface active and can readily adsorb to the air-water interface, the surface elasticity of an interface stabilised by cubosomes is considerably lower than that of saturated liposomes. This may, in part, explain why unsaturated emulsifiers are less effective at providing foam stability in the absence of fat. Specific choice of emulsifier is ultimately limited by legislation. Whilst some alternative emulsifiers, such as polyglycerol esters of monoglycerides also show excellent foams stabilising properties in the absence of fat in a manner similar to that of saturated monoglycerides, these do not currently have clearance with the US and EU markets for application within ice cream formulations.

The use of monoglycerides to improve the sensory properties of zero-fat ice cream provides an effective example of how the relationship between ingredients processing and product microstructure can be manipulated to give improvements in the quality of low and zero fat foods.

12.5 Margarine

12.5.1 *Historical perspective*

Margarine was invented and patented by Mège Mouriès in 1869 as the result of a national competition from Emperor Napoleon during the economic crisis leading up to the Franco-Prussian war. Napoleon III needed a cheap butter substitute, which would feed his armies and remain edible after long journeys. Thus the original advantage of margarine was that it offered a *high* calorific energy source that would be microbiologically stable for several months. Since then consumer demand and a changing world over the last 120 or so years have spurred margarine (spread) development to become one of the healthier (low fat) food types available today.

Mouriès theory was that butter fat was formed in the udder of the cow from its own fat and milk, so he mixed oleo (beef tallow) and skimmed milk and added a strip of udder to mimic the way in which milk is curdled. He found that if he chilled, stirred and worked the mixture, it formed a white buttery mass with a pearly sheen, which he named after *margos*: Greek for pearl (Davidson, 1999). This biological reasoning was completely wrong, but Mouriès had succeeded in producing a butter-like substance that has now become an indispensable staple on bread or as a cooking aid in large areas of the world.

The real microstructure and a schematic diagram of a typical margarine are shown together in Fig. 12.10. What is clear from the Cryo-TEM inset photo is that the margarine is inhomogeneous at a microscopic level, consisting of a finely divided water phase in a continuous phase comprising fat crystals and liquid oil.

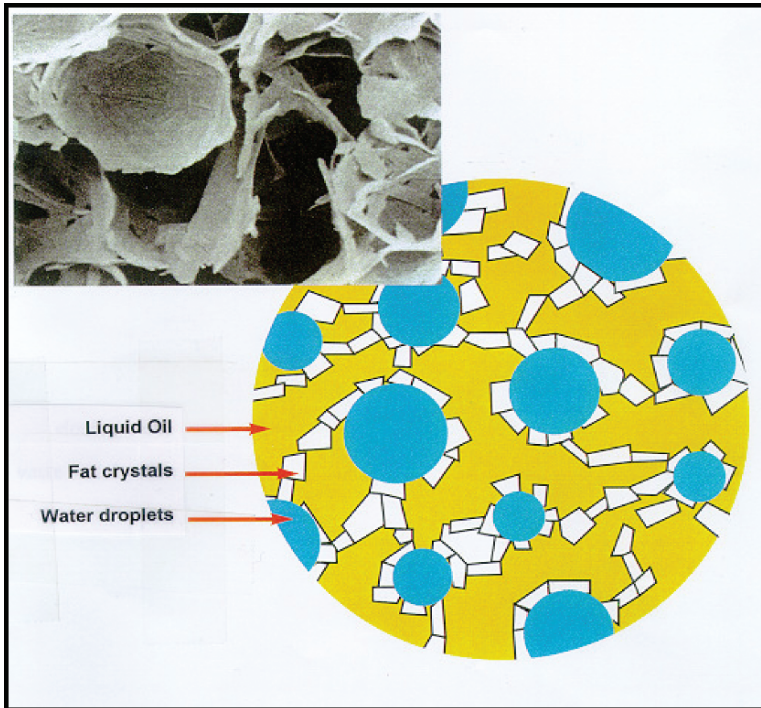

Fig. 12.10 Upper left corner: Cryo-SEM image of a fat crystal network in a 60% fat-continuous spread; oil and water have been removed from the sample for clarification

Conceptually we can think of margarine as a particle-filled gel in a plastic network as shown schematically beside the physical microstructure.

Margarine is technically an oil-in-water emulsion. Depending on legislation, full fat margarine has between 80 and 82% fat as this was the original benchmark definition of full fat butter which it had to mimic.

As is well known, oil and water don't readily mix or stay mixed, but for full fat margarine it is almost impossible *not* to make a stable emulsion. This is due to the solid fat crystals present in the overwhelming continuous phase rapidly adsorb to the oil-water interface during the manufacture of the pre-emulsion and crystallise out upon cooling during processing: classical Pickering stabilisation.

The product has to be microbiologically safe, both in transit to the shops and afterwards during repeated use (open shelf-life). Additionally, it has to function as a heat transfer medium in the kitchen during cooking or baking, it functions as an ideal carrier of fat soluble flavours, and it improves the 'mouthfeel' of bread by acting as a lubricant. It should also spread directly from the fridge without tearing the bread. It should be healthy by providing essential fatty acids, fat-soluble vitamins and aid in the uptake of other fat-soluble ingredients. Recent developments now offer cholesterol reduction with regular intake and margarine is an excellent

vehicle to provide a delivery platform for functional ingredients in many parts of the world (e.g. Nestel et al., 2001)

Margarine quality has come a long way since the first crude products from 130 years ago. The first technological improvements were in the refinement of the triglyceride processing (hardening and fractionation) in the early twentieth century. This led to better tasting fat (less rancidity as metals were removed to reduce oxidation) and also allowed the 'design tools' to manipulate melting curves for *blends* of fats to tailor margarine to different applications e.g. frying, baking or spreading on bread. (e.g. Bockisch, 1993).

12.5.2 Low and Very Low Fat Spreads

Around the mid 1970s, as consumers became more health conscious, the drive to lower fat levels in the edible fats sector began. Fat levels were reduced from the traditional 80% levels to 60% (reduced fat spread) and then through further development to 40% fat (low fat spread) in the 1980s. Processing of these so-called reduced fat spreads was still the same as full fat, namely a fat-continuous process, but when the dispersed water phase volume reached 60% in the low fat spreads, novel water phase control through process and emulsifiers was needed. Using the traditional process route at 40% fat resulted in water continuous systems so a new 'inversion' process was developed. The choice of emulsifier was now crucial in controlling the balance between break-up and coalescence in the product to effectively force the equilibrium towards coalescence to drive phase inversion from a water continuous pre-mix to a fat continuous product. This is a non-trivial challenge for the emulsion scientist. The product begins as a thin water continuous liquid pre-mix which is cooled under controlled shear until it phase inverts to become the thick spreadable plastic structure we know as margarine. However if there is a problem during manufacture the cooled product has to be re-heated and re-worked back to a water continuous state where it is re-processed in the pre-mix tank. When the margarine is consumed it should also re-invert quickly in the mouth to provide salt release. Thus there is a delicate interplay between small molecular weight monoglycerides and lecithins (fat continuous) and milk proteins (water continuous) to get the required emulsion stability during pre-mix, inversion, storage and in-use.

The trend in fat reduction has continued into the 1990s where the technical limit based on conventional processing is around 20% fat. Holding 80% water in 20% fat is a challenge in colloidal packing and can only be accomplished by using powerful water-in-oil promoting emulsifiers such as Admul wol (Polyglycerol polyricinolate). Effectively the emulsion is beyond the close-packed limit for random spheres and as such exists as a polyhedral mass, where the internal pressure to re-coalesce and phase separate is high.

Fortunately, as little as 0.5% Admul Wol will emulsify and stabilise 80% water in 20% oil. Additional product stability can be gained by thickening the aqueous phase by biopolymers. However the problem now shifts to making the spread de-stabilise

in the mouth during mastication to allow salt release and to reduce unnecessarily thick mouthfeel. This is a difficult compromise to make; stable during processing, storage and spreading, becoming physically unstable during the transit time (mastication) in the mouth. A replacement for Admul Wol having the same physical stability but better mouthfeel is a Holy Grail in low or very low fat spreads.

Another low fat challenge is to obtain the same product functionality (cake baking, shallow frying, and on bread). For kitchen applications, fat is *the* perfect medium to transfer heat during the cooking process as it has a much higher boiling point than water. In particular for baking, the fat phase is crucial during the early steps of air incorporation and stabilising when whipping the cake batter. If the batter doesn't have enough entrained air, or the bubble size distribution is not optimal, then the final cake texture and crumb structure is not good. Solid (saturated) fat (SAFA) plays an important role here traditionally, so when one goes from 80% fat to say 40% fat the baking functionality is quickly lost. To restore this to the high fat standard required a change in emulsifier type and level. The supplementary use of alpha-tending emulsifiers (monoglyceride derivatives) or anionics (SSL, CSL) were found to compensate for the loss of SAFA upon reduction of fat level. In addition, the use of mono-glycerides has a beneficial effect on the anti-staling of the starch allowing a longer shelf-life of the baked product. (Wootton et al., 1967; Mizukoshi, 1997)

At 60% fat emulsifiers alone can compensate for reduced kitchen functionality, but when the fat level is reduced to 40%, processing necessitates that the water phase is thickened, typically by biopolymers such as starch or alginate. Then the kitchen performance is severely hampered as the biopolymers tend to burn or discolour during heating. In addition spattering (explosive loss) of the water phase during frying becomes a bigger issue as the fat level is reduced. To combat spattering, lecithin is added to promote the flotation of water droplets to the air/oil interface during frying where they can harmlessly evaporate. Salt also has a positive effect on reducing spattering by functioning as anti-bump crystals during frying. In practice the limit for general kitchen functionality is thus 60% fat where a viscous water phase is not needed for processing.

Duplex emulsions (O/W/O) have also been considered as a theoretically attractive route to lowering fat level as the internal water phase under some circumstances can 'hide' some of the external fat phase. In practice there are two main problems: processing is not perfect as the first emulsion W/O has to be carefully emulsified into the bulk fat/oil to make the O/W/O. Since emulsification requires shear it is inevitable that the duplex emulsion is broken and thus yields are low. The second problem is coalescence of internal phase during storage, which again leads to loss of overall emulsion stability. Recent successes have been made with duplex emulsion manufacture using microfluidic devices (e.g. Nisisako et al., 2005). However these currently manufacture at single drop rates so are many orders of magnitude too slow to be commercialised. Membrane emulsification has also shown promise in duplex manufacture, but with systems containing protein as one emulsifier, fouling and blocking of pores is a difficult problem here (Hitchon et al., 1999).

12.5.3 Zero-Fat Spreads (Lipogel Technology)

It is the ambition of many product developers to successfully replace all the fat in a product whilst maintaining acceptable sensory properties of the food product. In the case of spreads, which are generally a high fat food, this presents an incredibly challenging technical problem. A number of approaches have been tried including gelling bio-polymers, shear-gelled systems and the use of microparticulated proteins. One particular approach to this problem is to use the mesophase properties of monoglycerides and other emulsifiers in solution to design structures with acceptable material and sensory properties.

Figure 12.11 shows a typical phase diagram of a monoglyceride system. Given the relative simplicity of the chemistry of this system it is surprising how rich the microstructural possibilities are as witnesses by the different mesophase possibilities. A summary of this approach is that emulsifiers, due to their amphiphilic nature, display particular phase behaviour in solution in the absence of fat. For example, through control of formulation and process, monoglyceride lamellar structures can be crystallised into water-swollen α -gel crystal structures which can provide spread-like textures, even for relatively low concentrations of emulsifier. Typical levels of emulsifier are 4–10% which when processed properly can hold 96–90% water in a plastic, spread like rheology. These liquid crystal lamellar phases are sometimes called lipogels. Small amounts (5%) of fat can also be included but processing becomes critical.

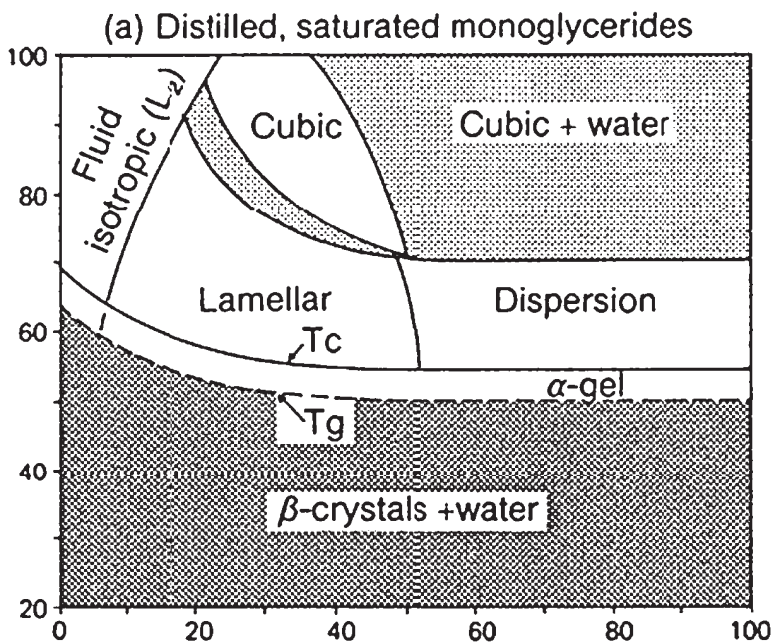

Fig. 12.11 Phase diagram showing possibilities of (edible) structured mesophases (Krog, 1997, with permission)

Nutritionally 1 g fat (SAFA) is comparable to around 20 g of lipogel which offers a spreadable product at low nutritional load. This structuring/nutritional ratio would not be possible with conventional fat –continuous technology.

The main challenge of lipogel technology is to manipulate the phase behaviour of the emulsifier systems to provide the most appropriate crystalline structure for the particular application, thus optimising the rheological properties of the lipogel. Often co-emulsifiers are needed (depending on pH); however, salt is known to interfere with mesophase formation. However, through appropriate use of emulsifier blending and processing it is possible to create lipogel structures for a wide range of applications, not just for use in zero-fat spread systems. In addition because monoglycerides are lipid based, they can incorporate the same fat soluble flavours and colorants normally used in high fat margarine which is a distinct advantage above water-continuous products as zero fat alternatives. Since lipogel contains high levels of surfactant it performs surprisingly well as a baking margarine because the monoglycerides aid the aeration step during batter preparation.

Other applications of the lipogel technology have now been extended to include zero fat dressings, mayonnaise, ice cream, whipping cream, and frozen desserts but the sensory properties of this class of products often differs from the high fat version.

12.5.4 Nutritional Enhancements

The food industry has come a long way in the last few decades. Particularly now that most developed countries have the luxury of eating (often more than) enough calories per day the emphasis has shifted away from absolute level of fat or oil to *quality* of fat or oil. Thus for example most spreads now sold typically contain 40% fat and less high fat margarine or zero fat spreads are sold today. In addition the consumer is constantly looking for more functionality in the products. This can take many physical or nutritional forms such as easier spreadability or spoonability from the packaging, fortification (vitamins and minerals) and more recently to complex functional claims such as reduced cholesterol, blood pressure, improved satiety at reduced calories, or even improved mental performance (e.g. Upritchard et al., 2005).

For each of these functional claims there will typically be a preferred product format depending on functional active and even a preferred targeted part of the body to deliver the functional ingredient to. Manufacturers will have to use clever emulsion design rules to take account of break-down under physiological conditions to be able to make verifiable functional claims. For example fast breakdown in the mouth boosts flavour release and salt perception; however it may be necessary to get an intact emulsion into the stomach or even small intestine to claim proper (improved) bioavailability of a fortified product.

Such challenges between emulsion science, processing and nutritional demands will take functional food claims (and thus emulsion science) to a new level in the next decades in response to ever increasing consumer demand for healthy, nutritious and good tasting food.

References

- Besner H. and Kessler H.G. (1998). Interfacial interaction during the foaming of nonhomogenized cream. *Milchwissenschaft* **53** (12): 682–686.
- Bockisch M. (1993). Nahrungsfette und Öle. *Handbuch der Lebensmitteltechnologie*, Ulmer Verlag, Stuttgart, Germany.
- Boode K. and Walstra P. (1993). Partial coalescence in oil-in-water emulsions.1. Nature of the aggregation. *Colloid Surface A* **81**: 121–137.
- Boode K., Walstra P. and DeGroot-Mostert A.E.A. (1993). Partial coalescence in oil-in-water emulsions.2. Influence of the properties of the fat. *Colloid Surface A* **81**: 139–151.
- Brooker B.E. (1993). The Stabilization of air in foods containing fat—a review. *Food Structures* **12** (1): 115–122.
- Bruhn C.M. and Bruhn J.C. (1988). Observations on the whipping characteristics of cream. *Journal of Dairy Science* **71** (3): 857–862.
- Buchheim W. (1991). Microstructure of whippable emulsions. *Kieler Milchw Forsch* **43** (4): 247–272.
- Davidson A. (1999). *The Oxford Companion to Food*, p. 479, OUP.
- Flack E. (1985). Foam Stabilization of dairy whipping cream. *Dairy Industries International* **50** (6): 35–37.
- Goff H.D. (1997). Instability and partial coalescence in whippable dairy emulsions. *Journal of Dairy Science* **80** (10): 2620–2630.
- Hitchon B., Gunter W.D., Gentzis T., Bailey R.T., Joscelyne S.M. and Tragardh G. (1999). Food emulsions using membrane emulsification: conditions for producing small droplets. *Journal of Food Engineering* **39**(1) 59–64(6).
- Krog N. and Larsson K. (1992). Crystallisation at interfaces in food emulsions—A general phenomenon. *Fett Wissenschaft Technologie-Fat Science Technology* **94** (2): 55–57.
- Krog N. (1997). Food emulsifiers and their chemical and physical properties in food emulsions, 3rd Ed. (SE Friberg and K Larsson), Marcel Dekker, NY, pp 141–188.
- Leser M.E. and Michel M. (1999). Aerated milk protein emulsions—New microstructural aspects. *Current Opinion in Colloid & Interface Science* **4** (3): 239–244.
- Mizukoshi M. (1997). Baking mechanism in cake production. *Journal of Food Engineering* **41**: 97–100.
- Needs E.C. and Huitson A. (1991). The contribution of milk serum-proteins to the development of whipped cream structure. *Food Structures* **10** (4): 353–360.
- Nestel P., Cehun M., Pomeroy S., Abbey M. and Weldon G. (2001). Cholesterol-lowering effects of plant sterol esters and non-esterified stanols in margarine, butter and low-fat foods. *European Journal of Clinical Medicine* **55**: P1084–P1090.
- Nisisako T., Okushima S. and Torii T. (2005). Controlled formulation of monodisperse double emulsions in a multiple-phase microfluidic system. *Soft Matter* **1**: 23–27.
- Pelan B.M.C., Watts K.M., Campbell I.J. and Lips A. (1997). The Stability of Aerated Milk Protein Emulsions in the Presence of Small Molecule Surfactants. *Journal of Dairy Science* **80**: 1010, 2631–2638.
- Segall K.I. and Goff H.D. (1999). Influence of adsorbed milk protein type and surface concentration on the quiescent and shear stability of butteroil emulsions. *International Dairy Journal* **9** (10): 683–691.
- Stanley D.W., Goff H.D. and Smith A.K. (1996). Texture-structure relationships in foamed dairy emulsions. *Food Research International* **29** (1): 1–13.
- Tual A., Bourles E., Barey P., Houdoux A., Desprairies M. and Courthaudon J.L. (2005). Effect of surfactant sucrose ester on physico-chemical properties of dairy whipped emulsions. *Sciences Des Aliments* **25** (5–6): 455–466.
- Tual A., Bourles E., Barey P., Houdoux A., Desprairies M. and Courthaudon J.L. (2006). Effect of surfactant sucrose ester on physical properties of dairy whipped emulsions in relation to those of O/W interfacial layers. *Journal of Colloid Interface Sciences* **295** (2): 495–503.

- Upritchard J.E., Zeelenberg M.J., Huizinga H., Verschuren P.M. and Trautwein E.A. (2005). Modern fat technology: what is the potential for heart health? *Proceedings of the Nutrition Society* **64** (3): 379–386.
- van Aken G.A. (2001). Aeration of emulsions by whipping. *Colloids and Surfaces A-physicochemical and Engineering Aspects* **190** (3): 333–354.
- Vanapalli S.A. and Coupland J.N. (2001). Emulsions under shear—The formation and properties of partially coalesced lipid structures. *Food Hydrocolloids* **15** (4–6): 507–512.
- Weitzlab. (<http://www.deas.harvard.edu/projects/weitzlab/research/Microfluidics/Microfluidic.html>)
- Wootton J.C., Howard N.B., Martin J.B., McOsker D.E. and Holmes J. (1967). The role of emulsifiers in the incorporation of air into layer cake batter systems. *Journal Cereal Chemistry* **44**: 333–345.
- Zhang Z. and Goff H.D. (2005). On fat destabilization and composition of the air interface in ice cream containing saturated and unsaturated monoglyceride. *International Dairy Journal* **15**: 495–500.

Chapter 13

Guidelines for Processing Emulsion-Based Foods

Ganesan Narsimhan and Zebin Wang

13.1 Introduction

Emulsions are dispersions of one liquid into the second immiscible liquid in the form of fine droplets. Emulsions can be classified as either oil-in-water or water-in-oil emulsions depending on whether oil or water is the dispersed phase. Milk, cream and sauces are some examples of oil-in-water emulsions whereas butter and margarine are examples of water-in-oil emulsions. Ice cream and fabricated meat products are complex oil-in-water emulsions in which either additional solid particles are present or the continuous phase is semi-solid or a gel. Some examples of emulsions is shown in Table 13.1. Formation of emulsion results in a large interfacial area between two immiscible phases and therefore is usually associated with an increase in free energy. Consequently, emulsions are thermodynamically unstable, i.e., they will phase separate eventually. However, emulsifiers and proteins are usually employed in the formulation. They adsorb at the liquid-liquid interface thus lowering the interfacial tension. Smaller interfacial tension helps in the dispersion of one phase in the form of fine droplets by lowering the required interfacial energy. In addition, the emulsifiers and proteins also modify the interdroplet forces thereby either preventing or retarding the rate of coalescence of colliding droplets during emulsion formation. Formulation therefore influences the size of emulsion drops formed using different types of emulsification equipment. Modification of interdroplet forces also helps in prolonging shelf life (kinetic stability) by slowing the rate of coarsening of emulsion drop size due to coalescence during storage. Proteins and emulsifiers also help in the extension of shelf life by providing rheological properties to the liquid-liquid interface. The main focus of this chapter is formation of emulsion. The chapter attempts to highlight the salient features of formation of emulsions and a brief description of different factors that control the drop size. Different types of emulsification equipment, the nature of flow field, breakup and coalescence of droplets and prediction of drop size during emulsion formation are discussed. No attempt has been made to discuss the mechanisms of destabilization of emulsion products during storage. Comprehensive treatments of this subject can be found elsewhere (Narsimhan, 1992; Robins and Hibberd, 1998; McClements, 1999; Becher, 2001).

Table 13.1 Typical food colloids

Food	Type of emulsion	Method of preparation	Mechanism of stabilization
(1) Milk	O/W	Natural product	Protein membrane
(2) Cream	A + O/W	Centrifugation	As (1) + particle stabilization of air
(3) Ice cream	A + O/W	Homogenization	As (2) + ice cream network
(4) Butter and margarine	W/O	Churning and in votator	In crystal network
(5) Sauces	O/W	High-speed mixing and homogenization	By protein and polysaccharide
(6) Fabricated meat products	O/W	Low-speed mixing and chopping	Gelled protein matrix
(7) Bakery products	A + O/W	Mixing	Starch and protein Network

Source Darling and Birkett (1986)

O oil, A air, W aqueous phase

13.2 Emulsification Equipment

Many laboratory to large scale emulsion forming equipments are commercially available. Each type of equipment has its advantage and disadvantage. Selection of emulsification equipment depends on many factors, such as the scale of production, the properties of starting material, the desired drop size distribution, physicochemical properties of final emulsion, and capital and operating costs. Main types of emulsification equipment are discussed below.

13.2.1 Colloid Mill

Colloid mill is a type of continuous emulsification equipment. Although there are many commercial designs available to obtain different performance, the principle of operation is quite similar. Figure 13.1 shows the schematic of a colloid mill. A gap is formed by the rotor and the stator, which is adjustable by the adjusting ring. Coarse emulsion is fed into the gap. High speed rotation of the rotor exerts high shear stress on the droplets and breaks them into smaller ones. The shear stress can be adjusted by changing the gap (usually from 50 μm to 1000 μm) and the rotation speed (usually from 1000 rpm to 20000 rpm) (McClements, 1999). In addition to increasing shear stress, increasing residence time also decreases droplet size, either by decreasing the flow rate or recycling the products.

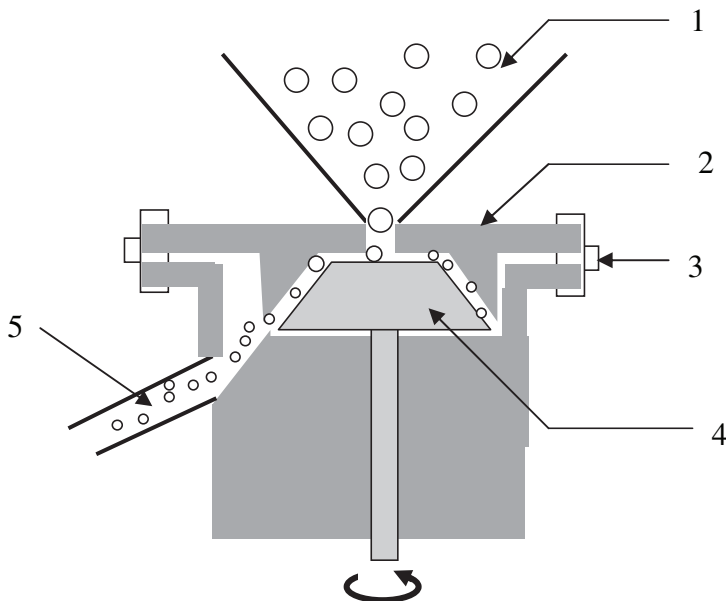

Fig. 13.1 Schematic of colloid mill. 1 Feed (coarse emulsion), 2 stator, 3 adjusting ring, 4 rotator, 5 outlet (fine emulsion)

Many factors affect the operation of a colloid mill. High rotation speed, smaller gap thickness, low flow rate will make finer droplets albeit at higher energy consumption. Geometry and material of rotator/stator also affect the energy consumption and emulsion quality. Due to energy dissipation, the temperature of product will increase if no cooling system is associated with the mill. High temperature is unfavorable for the emulsion stability.

Colloid mill is suitable for processing intermediate to high viscosity fluids. Typical drop size from colloid mill is between $15\ \mu\text{m}$ (McClements, 1999). Usually the feed is pre-emulsion, because the efficiency of drop breakup is much higher for pre-emulsions than for pure water and oil feeds.

13.2.2 High Speed Blender

High speed blender is a batch emulsification method most commonly used to disperse oil into liquid phase (Brennen et al. 1990). The liquid (oil and liquid phase) is placed into a vessel and agitated by a high speed stirrer. The product scale may be small (several cm^3) to large (several m^3). The stirrer rotates at rather high speed (usually hundreds of rpm to thousands of rpm) thus resulting in a velocity field with longitudinal, rotational and radial velocity gradients. In addition, drop breakup is

also facilitated by turbulence. Such gradients exert shear stress upon the fluid, disrupt the interface between the oil and the liquid phase, and finally form droplets. Because the velocity field highly depends on stirrer geometry, the efficiency of emulsion formation is strongly affected by the design of stirrer. There are a number of different types of stirrer available for different situations. Among them, the most commonly employed impeller is disk turbine. Turbine impellers create a predominantly radial flow field in the tank.

High speed blender is very useful for emulsions with low viscosity fluid. High rotational speed and longer stirring time result in a smaller droplet size. Typically, the droplet size obtained using a high speed blender is about 2–10 μm (McClements, 1999).

During the stirring, energy dissipation also increases the temperature of emulsions. If long time stirring is needed, a cooling system is also necessary to control the temperature.

13.2.3 High Pressure Homogenizer

The term homogenization means reduction of the droplet size of dispersed phase by forcing the coarse emulsion through a narrow channel at high velocity. High pressure homogenizer is a continuous equipment to produce fine emulsions. Like a colloid mill, it works at a much higher efficiency for pre-emulsions than for pure oil and liquid phases. Compared to colloid mill, it is more suitable for low and intermediate viscosity fluids.

The schematic of high pressure homogenizer is shown in Fig. 13.2 (Brennen et al., 1990). A valve and a valve seat form a narrow gap. Typical thickness of the gap is between 15 and 300 μm , which is adjustable in many commercial homogenizers. The pre-emulsion is pumped through the channel at high pressure. The pressure is adjusted by the adjusting handle in a pressure range, which depends on different designs. In some homogenizer, the pressure may as high as 10000 psi. Once the coarse emulsions pass through the narrow gap, the pressure energy is converted to kinetic energy and the intense turbulent and shear stresses exerted on the droplet break them into small ones (Phipps, 1985). Cavitation may also be responsible for the breakup of emulsion droplets (Phipps, 1985).

Smaller gap thickness and/or higher homogenizer pressure will result in smaller droplet size. However, this will require more energy. Because the residence time in the homogenizer is usually very small, it is possible that the emulsifying agent is poorly distributed over the newly created liquid-liquid interface, especially when the emulsifying agent is protein. In such cases, the fine droplets that leave the homogenizer tend to cluster and clump. To overcome this, a “two-stage” homogenization process is applied in some commercial homogenizers (Brennen et al., 1990). The coarse emulsions pass through a high pressure stage to break up the droplets, and then enter a low pressure valve to disrupt any clumps that may have been formed.

High pressure homogenizer is very efficient to reduce the droplet size of an emulsion. Typical droplet size is about 0.1 μm , and in some homogenizers it may

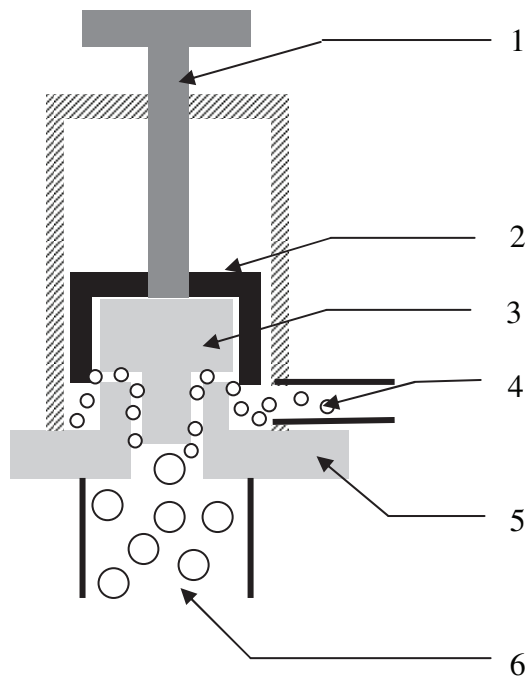

Fig. 13.2 Mechanism Schematic of pressure homogenizer. **1** pressure adjusting handle, **2** breaker ring, **3** valve, **4** outlet (fine emulsion), **5** valve seat, **6** inlet (coarse emulsion)

be as low as $0.02\ \mu\text{m}$ (Brennen et al., 1990). Another advantage is that the temperature increase is small unless the emulsions are recycled several times in multiple passes or the homogenizer pressure is extremely high.

13.2.4 Other Equipment

Besides the three types of emulsion forming equipment discussed above, there are several other types of equipment available to produce emulsions. Because they are not used as extensively, they are discussed briefly below.

Ultrasonic homogenizers utilize high-intensity ultrasonic waves to generate intense shear stress and pressure gradient (McCarthy, 1964; Gopal, 1968). Such stress and gradient are responsible for disruption of the droplets. Two types of methods are used to generate ultrasonic waves: piezoelectric transducers and liquid jet generators (Gopal, 1968). Piezoelectric transducers are ideal for preparing small volume of emulsions. It is a batch operation suitable for a laboratory use. The minimum droplet size may be as low as $0.1\ \mu\text{m}$. Liquid jet generator can be operated

continuously. Compared to high pressure homogenizer, the to energy efficiency is better, while the minimum droplet size is about $1\ \mu\text{m}$ (Brennen et al., 1990).

Microfluidization is used to form emulsions with extremely small droplet size (may be smaller than $0.1\ \mu\text{m}$) (Dickinson and Stainsby, 1988). In microfluidization, the two phases are separately accelerated to a high velocity and then simultaneously hit on a surface. As a result, the dispersed phase is broken into small droplets. By recycling the emulsion, the droplet size may be reduced.

Membrane homogenizers use glass membranes with uniform pore size to create droplets (Kandori, 1995). The dispersed phase is forced into the continuous phase. Because the droplet size strongly depends on the pore size of membrane in addition to interfacial tension between the dispersed and continuous phases, droplet size distribution of the product is very narrow. Also, the droplet size can be controlled by the membrane pore size. Another advantage is that the energy efficiency is high because of less energy dissipation compared to other emulsification equipment. The droplet size can be controlled to vary in the range of $0.3\ \mu\text{m}$ and $10\ \mu\text{m}$.

13.3 Droplet Phenomena

As a colloidal system, emulsion consists of large amount of small droplets. Droplet size and droplet size distribution has significant effects on the stability and texture of final product (Dickinson, 1992). The goal of emulsification is to form fine droplets, which depends on the breakup (or, technically, *disrupture*) of large droplets into smaller droplets. Due to the thermodynamic instability of colloidal system, small droplets tend to merge into larger ones, which is called *coalescence*. Drop breakup and coalescence are two contrary processes that exist in emulsification, as shown in Fig. 13.3. Shear stress and turbulent velocity fluctuations distort and breakup large droplets into small ones. The droplet size distribution of an emulsion produced in an emulsification equipment depends on the balance between the drop breakup and coalescence. The mechanism of breakup and coalescence will be discussed below.

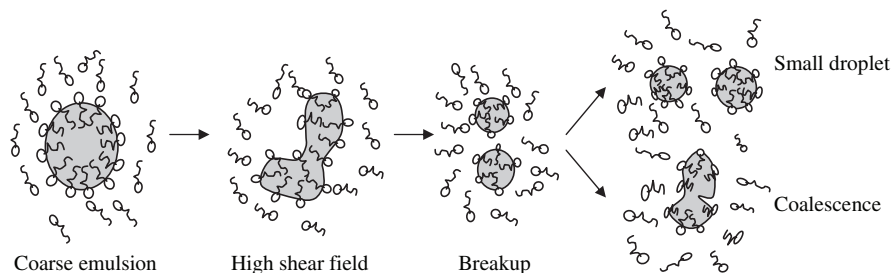

Fig. 13.3 Droplet breakup and coalescence in a high shear field

13.3.1 Drop Breakup

In order form an emulsion, one phase is to be broken up into the form of fine droplets and dispersed in the second continuous phase. The interfacial energy of the emulsion is proportional to the interfacial area of the emulsion droplets and the interfacial tension. Breakup of one phase in the form of fine droplets would result in an increase in the interfacial area and therefore would require an increase in the interfacial energy. Consequently, external energy input is necessary to increase the interfacial area. In order to minimize the interfacial energy, an emulsion droplet will assume spherical shape so as to minimize the surface area per unit volume. The surface energy of the droplet E is given by,

$$E = 4\pi\gamma R^2 \quad (13.1)$$

where γ is the interfacial tension and R is the droplet radius. Because of the radius of curvature of the droplet there is an interfacial stress or Laplace pressure p_l acting on the droplet which is given by,

$$p_l = \gamma \left(\frac{1}{R_1} + \frac{1}{R_2} \right) \quad (13.2)$$

R_1 and R_2 being the principal radii of curvature of the interface. For a spherical droplet, the above equation reduces to,

$$p_l = \frac{2\gamma}{R} \quad (13.3)$$

Any deformation of the droplet for its breakup will result in a decrease in its principal radii of curvature and therefore will require an increase in the interfacial stress acting on the drop surface. This increase in the interfacial stress is provided by an external flow that is induced in the continuous phase through energy input. It can easily be visualized that this external interfacial stress that is necessary for drop breakup is higher for smaller droplet. Since the droplet size is in the range of 0.1 to a few micrometers in food emulsion¹, extremely high energy input is usually necessary to break up coarse emulsion into such small sizes. Typical energy input for emulsion formation can range from 10^7 to 10^{12} Wm^{-3} . It should also be noted that only a small fraction of energy goes into the increase in the interfacial energy due to an increase in surface area. Most of the energy input is dissipated in the form of heat. Of course, this interfacial stress (and therefore the interfacial energy) can be decreased by decreasing the interfacial tension by the addition of food emulsifiers.

¹ The droplet size needs to be as small as possible in order to reduce the rate of creaming as well as Brownian collisions so as to minimize coarsening due to coalescence.

In a Colloid mill, the two phase mixture is subjected to extremely high shear when the mixture is passed through a narrow gap between a stator and a rotor. When the mixture is passed through a sudden contraction, such as a small orifice or pores of a membrane, the two phase mixture is subjected to hyperbolic/extensional flow. There may be other instances where a combination of these two types of flows may be encountered. These types of flow fields are laminar, i.e., the droplet Reynolds number (which is a measure of inertial and viscous forces) is very small. Consequently, the external stress that is applied to counteract the interfacial stress is predominantly viscous. Extensive investigations of drop breakup due to laminar flow have been carried out. A brief overview of these results will be given here.

13.3.1.1 Laminar Flow

Experimental observations of drop deformation in hyperbolic (Rumscheidt and Mason, 1961b) and simple shear (Taylor, 1932; Taylor, 1934; Karam and Bellinger, 1968; Torza et al., 1972) flows indicated that the drops deformed in the form of prolate ellipsoid for low deformations. The hyperbolic flow was generated by a four-roller apparatus (Rumscheidt and Mason, 1961a) whereas the shear flow was generated by a couette device (Bartok and Mason, 1957). These experiments were conducted for a range of viscosity ratios varying from 1.3×10^{-4} to 29. Taylor (Taylor, 1932) observed that the mode of burst of the droplets depended on the type of flow and viscosity ratio. The flow fields for these flows are given by,

$$\text{Hyperbolic flow: } u' = \frac{Gx'}{2} \quad v' = \frac{Gy'}{2} \quad w' = 0 \quad (13.4)$$

$$\text{Shear flow: } u = Gy \quad v = 0 \quad w = 0 \quad (13.5)$$

where u, v, w are the velocity components along axes X, Y, Z respectively and u', v', w' are velocity components along axes X', Y', Z' respectively as shown in Fig. 13.4. G is the shear rate. Hyperbolic flow is irrotational whereas shear flow is rotational with a rotation of $G/2$. A drop suspended in the middle of four-roller apparatus was distorted into a prolate ellipsoid oriented along X' , the deformation increasing with shear rate G . This continues until a critical shear rate G_B above which the drop bursts. For low viscosity ratio (drops of viscosity much smaller than the continuous phase), the deformed ellipsoidal drop developed pointed ends beyond the critical shear rate G_B eventually breaking off at the ends to form small satellite drops. For higher viscosity ratios, however, instead of developing pointed ends, the drop deformed into a thread which broke to form several daughter droplets.

For shear flow, at low G , the principal axis of prolate spheroid was $\pi/4$. The deformation and the angle of rotation both increased with G . Detailed analysis of four different types of deformations for different viscosity ratios is described (Rumscheidt and Mason, 1961b)) and shown in Fig. 13.5. At low viscosity ratio, the drop assumed a sigmoidal shape with the angle greater than $\pi/4$, pointed ends

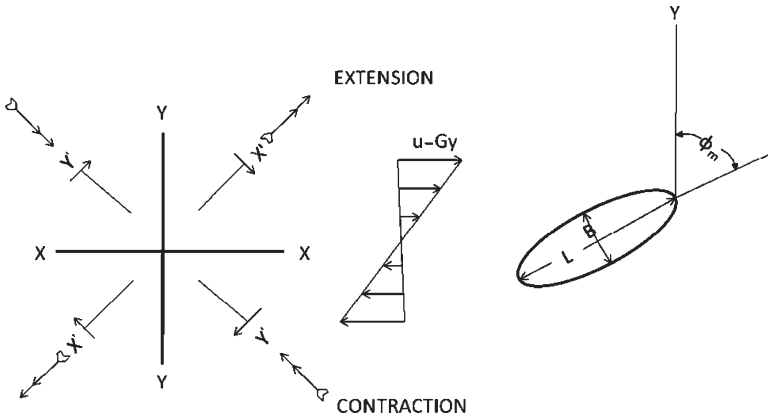

Fig. 13.4 Coordinate systems for hyperbolic and shear flow. The two fields are equivalent when $X'Y'$ axes are 45° behind XY axes and rotated clockwise at a rate $G/2$ as indicated on the left. The principal deformation axes are indicated by the double arrows. The parameters of a deformed fluid drop are shown on the right

were formed from which fragments were released. At intermediate viscosity ratios, when the shear rate reached the critical value G_B , the central portion of the drop suddenly extended into a cylinder which formed a neck eventually breaking into two identical daughter droplets and three satellite fragments. At even higher viscosity ratio, the drop extended into a thread which increased in length until it broke into a large number of daughter droplets. At very high viscosity ratio, the drop deformed into an ellipsoid with the angle of rotation reaching $\pi/2$. No drop breakup was observed.

General analysis of drop deformation in an external flow involves solution of the velocity field outside in the vicinity of the drop as well as inside the droplet. For creeping flow (low Reynolds numbers) the equations of continuity and motion in the vicinity of the drop is given by (Cox, 1969; Torza et al., 1972; Barthes-Biesel and Acrivos, 1973),

$$\nabla \cdot U = 0 \tag{13.6}$$

$$\nabla^2 U - \nabla P = 0 \tag{13.7}$$

where U and P are the dimensionless velocity and pressure respectively, all the quantities being nondimensionalized with respect to characteristic velocity, continuous phase viscosity and drop size. Similar equations can be written for fluid flow inside the drop. The solution of the above equations for velocity and pressure can be written in terms of spherical harmonics. The flow field U and the flow field U^*

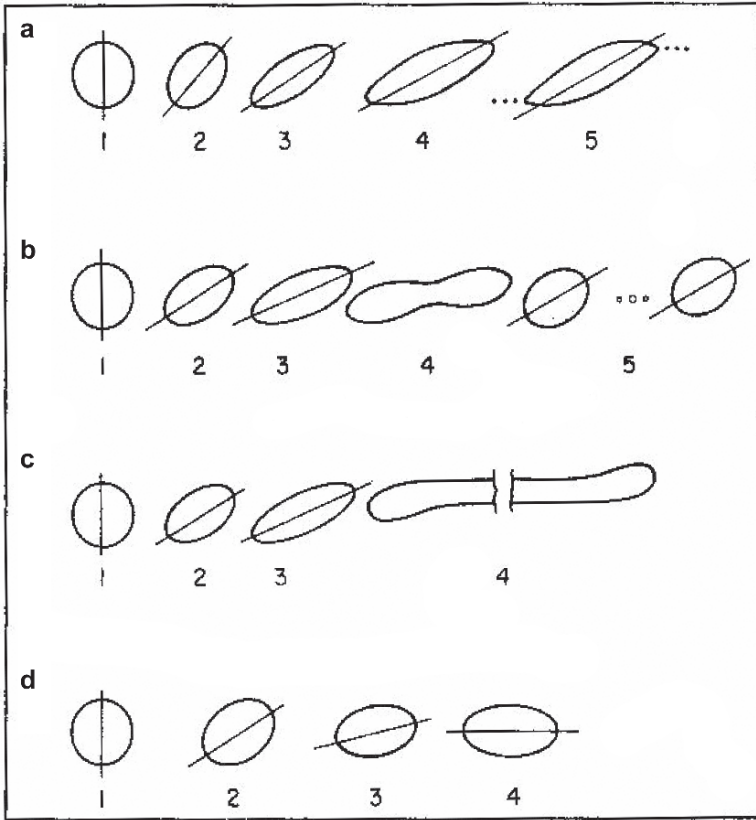

Fig. 13.5 Tracings from photographs of drops in shear flow showing the change in D, ϕ_m with increasing G up to breakup. (a) $\lambda < 0.2$ (b) and (c) $0.03 \leq \lambda \leq 2.2$ (d) $\lambda > 3.8$. (Torza et al., 1972)

inside the drop can be as expansion in terms of a small perturbation parameter ϵ as (Barthes-Biesel and Acrivos, 1973)

$$U = U_0 + \epsilon U_1 + \epsilon^2 U_2 \tag{13.8}$$

$$U^* = U_0^* + \epsilon U_1^* + \epsilon^2 U_2^* \tag{13.9}$$

In the above equation, U_0 and U_0^* are the continuous phase and drop phase velocity fields for undeformed spherical drop shape respectively, U_1, U_2, U_1^* and U_2^* are the first and second order deviations. Since the creeping flow equations are linear, the velocity fields for undeformed drop shape as well as deviations satisfy the creeping flow equations. The shape of the deformed drop surface can be written as (Barthes-Biesel and Acrivos, 1973)

$$r = 1 + \epsilon f_1(r_1/r, r_2/r, r_3/r) + \epsilon^2 f_2(r_1/r, r_2/r, r_3/r) \tag{13.10}$$

where f_1 and f_2 are shape functions. These equations have to be solved to obtain the shape functions recursively with the boundary conditions (1) normal components of velocity at the interface are continuous (2) the tangential components of velocity at the interface are continuous (3) the tangential components of the stress at the interface are continuous and (4) the difference in the normal components of the stress at the interface is counterbalanced by the interfacial tension forces due to curvature of the interface. The curvatures of the interface are expressed in terms of shape functions.

The deformation of the drop depends on two dimensionless parameters, namely, $\lambda = \mu^* / \mu$ and $k = \gamma / \mu G b$. Taylor's (Taylor, 1932) theoretical analysis of drop deformation in a shear flow considered the case for which the interfacial tension effects are dominant over viscous effects, i.e., $\lambda = O(1)$; $k \gg 1$ and obtained drop deformation to order k^{-1} . The drop was shown to deform into a spheroid with its major axis at an angle of $\pi/4$. He also considered the case for which the interfacial tension effects were negligible, i.e., $k = O(1)$; $\lambda \gg 1$ in which the drop deformation was obtained of order λ^{-1} . In this case, the drop deformed into a spheroid with its major axis in the direction of flow. This was then extended to the general case of drop deformation expressed in terms of a small deformation parameter upto a first order (Cox, 1969) and second order (Barthes-Biesel and Acrivos, 1973). The drop deformation was expressed in terms of a deformation parameter defined as,

$$D = \frac{(L - B)}{(L + B)} \quad (13.11)$$

L and B being the lengths of major and minor axes respectively of the deformed drop. For steady shear flow, the drop deformation and orientation are given by (Torza et al., 1972),

$$D = \frac{1}{k} \left(\frac{19\lambda + 16}{16\lambda + 16} \right) \quad (13.12)$$

$$\alpha = \frac{\pi}{4} + \frac{1}{k} \frac{(19\lambda + 16)(2\lambda + 3)}{80(1 + \lambda)} \quad (13.13)$$

When the droplet is exposed to a sudden shear flow, the transients of deformation of the droplet has been solved upto first order by Torza et. al. (Torza et al., 1972)

$$D' = D \left[1 - 2e^{-20Gkt/19\lambda} \cos(Gt) + e^{-40Gkt/19\lambda} \right]^{1/2} \quad (13.14)$$

Where the steady state deformation D is given by,

$$D = \frac{5(19\lambda + 16)}{4(1 + \lambda) \sqrt{(19\lambda)^2 + (20k)^2}} \quad (13.15)$$

The drop of radius b undergoes a transient damped wobble with a relaxation time $\tau = b \mu^* / \gamma$. Experimental observation of steady and transient deformations agree well with theoretical predictions for shear and hyperbolic flows.

The effect of external force on drop deformation can be described by a dimensionless number We , Weber number defined as,

$$We = \frac{\mu G b}{2\gamma} \quad (13.16)$$

which is the ratio of applied shear stress and laplace pressure. The drop deformation increases with Weber number eventually resulting in drop breakup at a critical Weber number We_{cr} . The maximum stable drop diameter d_{max} is given by,

$$d_{max} = \frac{2\gamma We_{crit}}{\mu G} \quad (13.17)$$

Theoretical prediction of drop breakup at a given imposed shear rate (Weber number) was accomplished from the minimum deformation parameter at which no solution exists for drop shape (Barthes-Biesel and Acrivos, 1973). Experimental observation of critical Weber number for different types of flows for different viscosity ratios is shown in Fig. 13.6. The figure also shows the slope $d \log We_{cr} / d \log \lambda$ as a function of viscosity ratio λ . This can be used to predict the effect of change in viscosity ratio on drop breakup. For low viscosity ratios, We_{cr} decreased with λ for simple shear and plane hyperbolic flows and reached a minimum. For simple shear flows, We_{cr} increased dramatically at higher viscosity ratios and reached infinity at a critical λ of around 4 indicating thereby that highly viscous drops do not rupture when exposed to simple shear. Such a behavior was not encountered for other flows. Also, We_{cr} was found to be much smaller for plane hyperbolic and extensional flows implying thereby that it is easier to break a drop in these flow fields.

Experimental measurements of drop size of an emulsion produced in a colloid mill for excess surfactant concentration at different dispersed phase viscosities were employed to infer We_{crit} (Walstra and Smulders, 1998). The results are shown in Fig. 13.7. The results seem to agree reasonably well with the values for single drops in simple shear flows for viscosity ratios upto about 2. Interestingly, drop breakup was observed for viscosity ratio as high as 10 rather than 4 as predicted for single drops which the authors attribute to possible contribution of elongation to the flow field.

13.3.1.2 Turbulent Flow

In a high pressure homogenizer, the two phase oil-water mixture is forced through a small gap between two plates at a high pressure. The pressure energy is converted to kinetic energy when the fluid flows through the small opening. In addition, the fluid is also subjected to high shear. Because of the large velocity of the fluid through the opening, the flow is highly turbulent, i.e., the Reynolds number is very large. The mechanism of drop breakage under these conditions is different from that in a laminar flow field. Because of turbulence, the droplet surface is subjected to random velocity and pressure fluctuations thus resulting in a bulgy deformation of the drop surface. In order for the droplet to rupture, the turbulent stresses acting

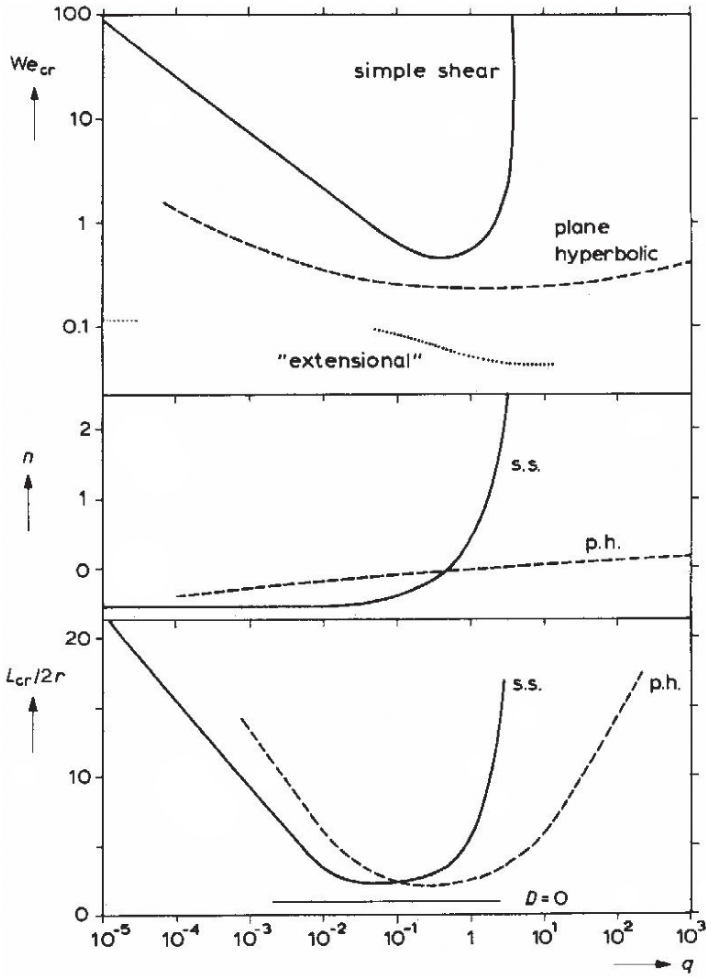

Fig. 13.6 Critical Weber number for breakup We_{cr} (i.e., the drop will break in the region above the curve); viscosity exponent $n = d \log We_{cr} / d \log \lambda$; and the largest drop dimension at burst L_{cr} relative to original drop diameter; for various types of steady flow as a function of viscosity ratio q (Walstra, 1983). S.S and P.h. refer to simple shear and plane hyperbolic flows respectively; D is the equilibrium deformation of the drop

on the drop surface should overcome the restoring force due to interfacial tension. The turbulent stress τ_{tur} is given by (Hinze, 1955),

$$\tau_{tur} = \overline{\rho u^2(d)} \tag{13.18}$$

where ρ is the density of the continuous phase and $\overline{u^2}$ is the mean square of the relative velocity fluctuations between two diametrically opposite points on the drop surface. Similar to the laminar case, one can define the dimensionless Weber number

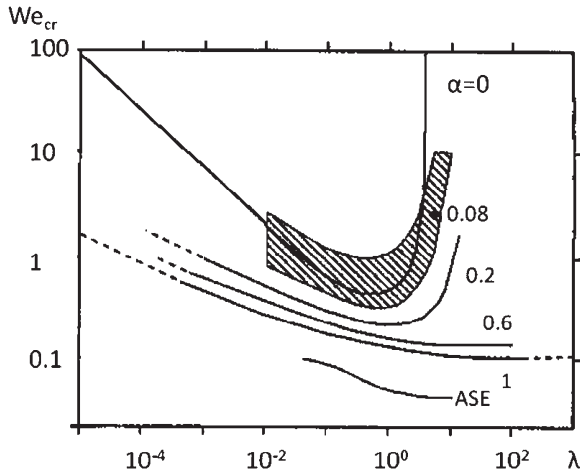

Fig. 13.7 Critical Weber number for break-up of drops in various types of flow. Single-drop experiments in two-dimensional simple shear ($\alpha = 0$), hyperbolic flow ($\alpha = 1$) and intermediate types, as well as a theoretical result for axisymmetrical extensional flow (ASE). The hatched area refers to apparent We_{cr} values obtained in a colloid mill (Walstra and Smulders, 1998)

$$We = \frac{\tau_{tur} b}{2\gamma} \tag{13.19}$$

as the ratio of turbulent stress and Laplace pressure. Experimental observations (Hinze, 1955) have indicated that the critical Weber number We_{cr} at which drop breakup occurs is close to unity. Consequently, the maximum stable drop diameter d_{max} is given by,

$$d_{max} \frac{4\gamma}{\tau_{tur}} = \frac{4\gamma}{\rho u^2 (d_{max})} \tag{13.20}$$

The velocity fluctuation in a turbulent flow field can be considered as superposition of disturbances of different wavenumbers (wavelengths). Each wavenumber corresponds to a correlation lengthscale of disturbance. Turbulence that is generated is of lengthscale corresponding to the lengthscale of equipment. The turbulence energy is then transmitted to smaller lengthscales. Since the viscous forces become important for sufficiently small lengthscales (large wavenumbers), this energy is eventually dissipated over these length scales in the form of heat. Even though the turbulent flow field is anisotropic over large lengthscales, for sufficiently large Reynolds numbers, the flow field is locally isotropic over lengthscales comparable to drop sizes encountered in food emulsions. The unique feature of local isotropy is that the flow field over these

lengthscales do not depend on the characteristics of turbulent forming equipment. The energy spectrum over these lengthscales is universal in that it depends only on energy dissipation rate per unit mass ε , density ρ and viscosity μ . The universal spectrum can further be subdivided into lengthscales of inertial and viscous subrange. In the inertial subrange, the energy is just convected from larger to smaller eddies whereas in viscous subrange part of the energy is also dissipated. The demarcation between the two subranges is the microscale of turbulence λ_m given by,

$$\lambda_m = \mu^{3/4} \rho^{-3/4} \varepsilon^{-1/4} \quad (13.21)$$

Eddies of size greater than λ_m mainly convect energy without dissipation and viscous dissipation is important only for eddies of size smaller than λ_m . From dimensional analysis, it has been shown by Kolmogorov (Levich, 1962) that the mean square velocity fluctuation over lengthscale in the inertial and viscous subranges are given by,

$$\overline{u^2(l)} \approx \varepsilon^{2/3} l^{2/3} \quad l (> \lambda_m) \quad (13.22)$$

$$\overline{u^2(l)} \approx \varepsilon \rho l^2 \mu^{-1} \quad l (< \lambda_m) \quad (13.23)$$

Using the above equation in the expression for the turbulent stress acting on a drop and from Eq. 13.20, the maximum stable diameter d_{\max} in the inertial subrange is given by,

$$d_{\max} \approx \varepsilon^{-2/5} \gamma^{3/5} \rho^{-1/5} \quad (13.24)$$

Of course the above expression is applicable only if $d_{\max} > \lambda_m$. Similarly, the maximum stable diameter d_{\max} in the viscous subrange is given by,

$$d_{\max} \approx \gamma^{1/3} \varepsilon^{-1/3} \left(\frac{\mu}{\rho} \right)^{1/3} \quad (13.25)$$

Of course the above expression is applicable only if $d_{\max} < \lambda_m$.

An analysis of drop breakup accounting for dispersed phase viscosity has been proposed (Calabrese et al., 1986). The disruptive turbulent stress acting on the droplet is assumed to be counterbalanced by cohesive interfacial tension force and viscous stresses that are generated inside the droplet for a maximum stable drop size. The following correlation was derived for droplets in the inertial subrange,

$$\frac{\rho_c \varepsilon^{2/3} d_{\max}^{5/3}}{\gamma} = C_5 \left[1 + C_6 \left(\frac{\rho_c}{\rho_d} \right)^{1/2} \frac{\mu_d \varepsilon^{1/3} d_{\max}^{1/3}}{\gamma} \right] \quad (13.26)$$

where C_5 and C_6 are constants.

In a high pressure homogenizer, the pressure energy is converted to turbulent kinetic energy. Since the kinetic energy is eventually dissipated in the form of heat

due to viscous dissipation, the energy dissipation per unit mass can be written as inlet homogenizer gauge pressure P_h (which is pressure drop through the homogenizer since the outlet pressure is atmospheric). Therefore, the energy dissipation rate per unit mass ε can be written as,

$$\varepsilon = \frac{P_h}{\theta} \quad (13.27)$$

where θ is the residence time of the fluid through the homogenizer valve. Using Bernoulli's equation, the average velocity through the homogenizer \bar{U} can be approximated as $\bar{U} = (P_h / \rho)^{1/2}$. Recognizing that the residence time $\theta = Z / \bar{U}$, Z being the path length of the homogenizer, we have,

$$\varepsilon = P_h^{3/2} \rho^{-1/2} Z^{-1} \quad (13.28)$$

Breakup of a droplet also depends on the time the disrupting force acts on the droplet. If the turbulent force does not act for sufficiently long time, the droplet will not be disrupted effectively. In order for the drop to deform, the eddy time (time during which the force fluctuation acts) should be larger than the drop deformation time. The eddy time $\tau(d_{\max})$ for maximum stable drop size is given by,

$$\tau(d_{\max}) = \frac{d_{\max}}{\left(\overline{u^2(d_{\max})}\right)^{1/2}} \quad (13.29)$$

where $\overline{u^2(d_{\max})}$ is given by either Eq. 13.22 or 13.23 depending on whether the drop size is in inertial or viscous subrange. The drop deformation time $\tau_{def}(d_{\max})$ is given by,

$$\tau_{def}(d_{\max}) = \frac{\mu_d d_{\max}}{2\gamma} \quad (13.30)$$

Therefore, it is more difficult to breakup droplets during one eddy time with higher dispersed phase viscosity. Some sample calculation of droplet disruption is shown in Table 13.2 (Walstra, 1983). It is seen that deformation times are usually smaller than eddy times, unless the ε or μ_d is extremely high.

13.3.1.3 Drop Breakage Rate

In addition to the characterization of maximum stable drop size, a number of mechanisms for drop breakage in a turbulent flow have been proposed. These models consider the deformation of a drop due to interaction with the turbulent flow field and the probability of breakup of a deformed droplet (Coulaloglou and Tavlarides, 1977; Narsimhan et al., 1979). The rate of breakage $\Gamma(d)$ of a droplet of diameter d is written as,

Table 13.2 Sample calculations for droplet disruption in isotropic turbulent flow (Only order of magnitude is shown) (Walstra 1983)

Variable ^a	Unit	Tank with stir	Ultra turrax	Homogenizer
ϵ	W/m ³	10 ⁴	10 ¹⁸	10 ¹²
l_e	μm	18	1.8	0.2
d_{max}	μm	400	10	(0.25) ^c
d_{min}	μm	0.3	0.3	0.3
$\tau(d_{max})$	μs	2500	10	(0.04) ^c
$\tau_{def}(\mu_d = 10^{-3})^b$	μs	20	0.5	0.01
$\tau_{def}(\mu_d = 1)^b$	μs	2×10 ⁴	500	10
$d_{max}(if < l_e)$	μm	(3000) ^c	30	0.3

^a Other variables: $\gamma = 10mN / m$, $\rho_c = 10^3 \text{ kg / m}^3$, $\mu_c = 10^{-3} \text{ Pa } \dot{c} \text{ s}$

^b For a globule of size d_{max}

^c Theory does not hold here

$$\Gamma(d) = \text{Eddy drop collision frequency } \times \text{ breakage efficiency} \quad (13.31)$$

In one model, the eddy arrival rate on a drop surface is visualized as a Poisson process. The relative velocity fluctuation between two diametrically opposite points of a droplet is assumed to be a normal distribution. Based on the assumption that the energy required for drop breakup is the increase in the surface energy of daughter droplets for binary equal breakup, the following expression for drop breakage rate was derived (Narsimhan et al., 1979):

$$\Gamma(d) = \lambda \text{erfc} \left(\frac{a\gamma^{1/2} d^{-5/6}}{\rho^{1/2} \epsilon^{-1/3}} \right) \quad (13.32)$$

where λ is the rate of arrival of eddies, a is a constant and γ is the interfacial tension. In the other model (Coulaloglou and Tavlarides, 1977), the rate of collisions of eddies with the droplet was calculated from the knowledge of the energy spectrum and the probability of drop breakup was assumed to be exponential. The following expression was derived for the rate of breakage

$$\Gamma(d) = k_1 \frac{\epsilon^{1/3}}{(1 + \phi)d^{2/3}} \exp \left[-k_2 \frac{\gamma(1 + \phi)^2}{\rho_d \epsilon^{2/3} d^{5/3}} \right] \quad (13.33)$$

where k_1 and k_2 are constants, ϕ is the dispersed phase fraction and ρ_d is the density of dispersed phase.

The drop breakage rates have been inferred from the experimental data of transients of drop size distributions in stirred lean liquid-liquid dispersions (Narsimhan et al., 1980; Narsimhan et al., 1984; Sathyagal et al., 1996) using similarity analysis. The inferred breakage functions were nondimensionalized with respect to the natural frequency of oscillation of drops to yield a satisfactory generalized plot against dimensionless drop volume. Experimental data were correlated to give the following equation (Narsimhan et al., 1980; Narsimhan et al., 1984)

$$\Gamma(v)\sqrt{\frac{\rho v}{\gamma}} = 5.75We^{3.2}\left(\frac{v}{D^3}\right)^{1.78} \quad (13.34)$$

where v is the drop volume, $We = N^2 D^3 \rho / \gamma$ is the Weber number representing the ratio of turbulent and surface tension forces, and D is the impeller diameter. For higher viscosity systems, the above correlation was extended (Sathyagal et al., 1996) to give the following correlation

$$\begin{aligned} \Gamma(v)\sqrt{\frac{\rho v}{\gamma}} = & 0.422 \exp\{-0.2478 \ln^2 \left[We \left(\frac{v}{D^3} \right)^{5/9} \left(\frac{\mu_c}{\mu_d} \right)^{0.2} \right] \\ & + 2.155 \ln \left[We \left(\frac{v}{D^3} \right)^{5/9} \left(\frac{\mu_c}{\mu_d} \right)^{0.2} \right] \} \end{aligned} \quad (13.35)$$

where μ_d and μ_c refer to dispersed phase and continuous phase viscosities respectively.

13.3.1.4 Cavitation Flow

A cavity will form if the pressure suddenly decreases to a critical value. The cavity will grow; some of the surrounding liquid will evaporate and move into it if the fluid keeps expanding. Such a cavitation flow is very important in ultrasonic and high pressure valve homogenizer (Gopal, 1968; Phipps, 1985). The cavity will collapse if there is a compression, resulting in an intense shock wave which propagates into the adjacent fluid. These waves cause the droplet to be deformed and disrupted. Such waves are associated by extremely high pressure and temperature. Although it lasts only for very short time and remain in a small local area, it will bring damage to the surfaces of the equipment over a long time, known as 'pitting' (Gopal, 1968; Phipps, 1985). Cavitation flow occurs only when the pressure change exceeds a critical value, known as *cavitation threshold* (McClements, 1999). For a pure liquid, the cavitation threshold is high therefore it is difficult to form a cavity. If gas bubbles or impurities are presented in the fluid, the cavitation threshold will decrease and consequently it is easier to form a cavity.

13.3.1.5 Effect of Non-Newtonian Fluids

The above discussions all assume a constant viscosity. That is, the fluid is Newtonian. However, most of fluids in food industry are non-Newtonian, which have pronounced effects on the breakup of droplets.

For a non-Newtonian fluid, the viscosity depends on the shear rate. For food systems, the liquid usually shows shear thinning behavior, for which the viscosity decreases with increasing shear rate. The liquid may have a yield stress, which

means no flow will happen below a certain shear rate; therefore zero shear rate viscosity is infinity. In emulsification equipment, shear rates are different from place to place. Such a difference results in difficulty to predict the behavior of flow and breakup of droplets. For a laminar flow, Eq. 13.17 can be used with apparent viscosity to give

$$d_{\max} = \frac{2\gamma We_{crit}}{G\mu_c'} \quad (13.36)$$

where We_{crit} can be obtained for the corresponding value of $q' = \frac{\mu_d'}{\mu_c'}$.

Often, many fluids in food formulations exhibit viscoelastic behavior with shear thinning. The relaxation time for disappearance of the elastic stress, τ_{mem} is used to characterize viscoelastic behavior. For a simple shear in viscoelastic liquid, the critical size for breakup is given by (Flumerfelt, 1972)

$$\frac{r_{crit}\mu_d G}{\gamma} = C_1 \tau_{mem} G + C_2 \quad (13.37)$$

where

$$C_1 = \frac{\mu_d}{(\mu_c')_0} \quad (13.38)$$

and C_2 is generally between 0.05 and 0.4 (Walstra, 1983). When $\tau_{mem} \rightarrow 0$, Eq. 13.37 reduces to $We_{crit} = C_2/q'$, corresponding to the result for Newtonian fluid.

When $G \rightarrow \infty$, Eq. 13.37 leads to

$$r_{crit} \geq C_1 \frac{\tau_{mem} \gamma}{\mu_d} \quad (13.39)$$

This implies that smaller droplets can never be disrupted, no matter how large the shear rate is. Hence, breakup can become very difficult for large relaxation times.

13.3.2 Drop Coalescence

In an emulsion forming equipment, the relative motion between droplets caused by turbulence or shear leads to collision between droplets, leading to their coalescence. The drop size of the emulsion is influenced by the rate of coalescence. In the following, we will discuss the evaluation of the rate of drop coalescence due to turbulence.

A colliding drop pair is subjected to interdroplet turbulent and colloidal squeezing force (van der Waals) due to which the intervening continuous phase liquid drains, leading to the coalescence of the pair. On the other hand, the colloidal repulsive

forces due to electrostatic and steric interactions counteract the squeezing force thus resulting in a force barrier (Narsimhan, 2004) which tends to prevent drop coalescence.

Very little information is available on drop coalescence in high pressure homogenizer during emulsion formation. A contrast matching technique was employed (Tsaine et al., 1996) to infer the drop coalescence in a high pressure homogenizer for surfactant stabilized emulsion. Their results indicated that high surfactant concentration was able to minimize coalescence though extensive coalescence was observed at low surfactant concentration and was found to be higher at higher homogenizer pressures. Drop coalescence in a high pressure homogenizer was inferred (Lobo and Sverika, 1997) from the fluorescence of hydrophobic probe that was allowed to transfer between oil droplets. A Monte carlo simulation was then employed to relate the fluorescence to the coefficient of variation of concentration distribution of the probe in the dispersed phase. These results were consistent with the earlier results of Taisne et. alL (Tsaine et al., 1996). Drop coalescence was found (Lobo and Sverika, 1997) to be insensitive to ionic strength. Narsimhan and coworkers (Mohan and Narsimhan, 1997; Narsimhan and Goel, 2001) have developed a methodology for the inference of coalescence rates in high pressure homogenizer from the experimental measurement of the evolution of number concentration of droplets to a negative step change in homogenize pressure. The rate of collision between drops of diameter d will depend on the predominant mechanism of collision. For collision due to turbulent shear, the rate of collisions v_c is given by (Mohan and Narsimhan, 1997)

$$v_c \propto P_h h \quad (13.40)$$

where P_h is the homogenizer pressure and h is the gap thickness in the homogenizer valve. For collision due to turbulence, the rate of collision will depend on whether the drop size is in the inertial or viscous subrange of the universal spectrum and is given by (Mohan and Narsimhan, 1997),

$$v_c \propto P_h^{1/2} h^{1/6}, \quad d > \lambda \quad (13.41)$$

$$v_c \propto P_h^{3/4} h^{1/4}, \quad d < \lambda \quad (13.42)$$

Inference of coalescence rate constants for pure oil in water emulsion in a high pressure homogenizer for different homogenizer pressures gave a functional dependence of $v_c \propto P_h^{0.722}$ indicating thereby that the predominant mechanism for drop coalescence is turbulence (Mohan and Narsimhan, 1997). The effects of homogenizer pressure, droplet size, ionic strength and surfactant concentration on the inferred coalescence rate constant for tetradecane in water emulsion stabilized by sodium dodocyl sulphate (Narsimhan and Goel, 2001) are shown in Fig. 13.8. The coalescence rate constant was found to increase with homogenizer pressure (see Fig. 13.8a) as a result of an increase in the turbulent squeezing force of colliding droplet pair at higher homogenizer pressure. The rate constant was also found to be lower for larger drop sizes (see Fig. 13.8b) because of the predominant

stabilizing effect of repulsive electrostatic interactions. The coalescence rate constant was found to be insensitive to variations in ionic strength (see Fig. 13.8c)

The coalescence rate constant was found to decrease with an increase in sodium dodecyl sulphate concentration (see Fig. 13.9) leveling off at higher surfactant concentration. This is because of the stabilizing influence due to an increase in the zeta potential of emulsion drops (see inset of Fig. 13.9).

13.3.2.1 Collision of Two Drops

Considering the mutual turbulent diffusive flux of two drops, the rate of collisions v_c is evaluated (Narsimhan, 2004) to give,

$$v_c = \frac{28\pi}{3} \alpha \epsilon^{1/3} (R_1 + R_2)^{7/3} n_1 n_2 \quad (R_1 + R_2) \geq \lambda \quad (13.43)$$

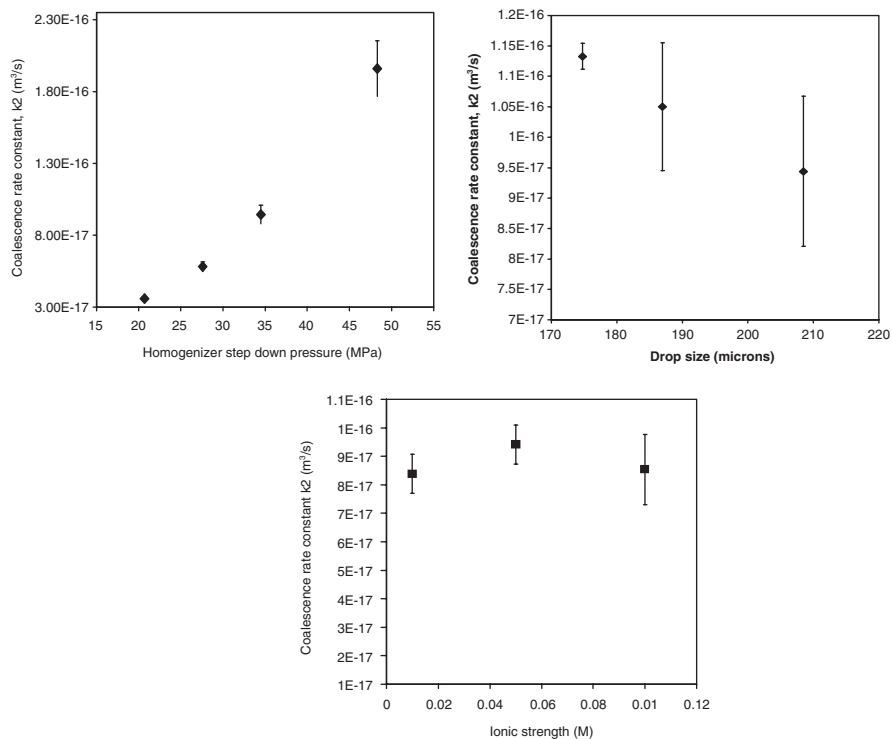

Fig. 13.8 The coalescence rate constant as a function of (a). homogenizer step down pressure; (b) droplet-size and (c) ionic strength (Narsimhan and Goel, 2001)

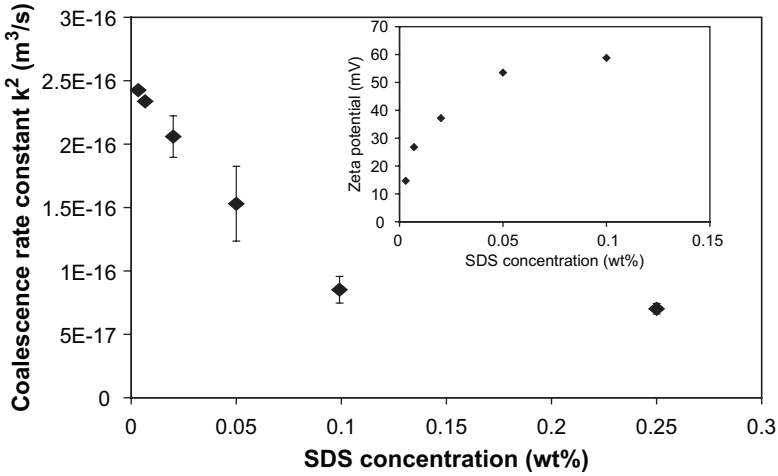

Fig. 13.9 The coalescence rate constant as a function of SDS concentration. Inset: Zeta potential of emulsion as a function of SDS concentration (Narsimhan and Goel, 2001)

$$v_c = \frac{4\pi n_1 n_2}{\frac{1}{3} v^{1/2} \epsilon^{-1/2} \left(\frac{1}{(R_1 + R_2)^3} - \frac{1}{\lambda^3} \right) + \frac{3}{7\alpha} \epsilon^{-1/3} \lambda^{-7/3}} \quad (R_1 + R_2) < \lambda \quad (13.44)$$

where $\alpha = \sqrt{2}$ and $\beta = 1$ are constants.

For equal sized drops of radius R , the above equations reduce to,

$$v_c = \frac{28\pi}{3} \alpha \epsilon^{1/3} (2R)^{7/3} n_0^2 \quad (13.45)$$

$$v_c = \frac{4\pi n_0^2}{\frac{1}{3} v^{1/2} \epsilon^{-1/2} \left(\frac{1}{(2R)^3} - \frac{1}{\lambda^3} \right) + \frac{3}{7\alpha} \epsilon^{-1/3} \lambda^{-7/3}} \quad (13.46)$$

where n_0 is the number concentration of drops.

The time scale of drop collision, τ_{coll} for equal sized drops can be defined as,

$$\tau_{coll} = \frac{n_0}{v_c} \quad (13.47)$$

where v_c is given by Eq. 13.45 or 13.46 and n_0 , the number of droplets per unit volume is given by

$$n_0 = \frac{3\phi}{4\pi R^3} \quad (13.48)$$

where ϕ is the dispersed phase fraction and R is the mean droplet radius.

For non deformable spherical particles, the drainage of continuous phase liquid between two colliding particles of size d and d' is given by Taylor's equation (Narsimhan, 2004).

$$\frac{dh}{dt} = \frac{2hF}{3\pi\mu} \left(\frac{1}{d} + \frac{1}{d'} \right)^2 \quad (13.49)$$

where h is the surface to surface distance between the drops and F is the interaction force between the two emulsion droplets.

By convention, the interaction force F is positive if repulsive and negative if attractive. For drops of equal size d , Eq. 13.49 becomes

$$\frac{dh}{dt} = \frac{8hF}{3\pi\mu d^2} \quad (13.50)$$

In a turbulent flow field, the droplet pair is subjected to random fluctuating turbulent force with mean force \bar{F} which will try to squeeze the colliding drop pair towards each other thus promoting coalescence. Van der Waals attractive force between the two drops would also promote coalescence. On the other hand, the electrostatic repulsive force between the two drops would tend to slow down the film drainage.

The mean turbulent force, \bar{F} is given by (Narsimhan, 2004)

$$\bar{F} = \frac{\pi d^2 \rho \overline{u^2}(d)}{4} \quad (13.51)$$

where $\overline{u^2}(d)$ is the mean square turbulent velocity fluctuation between the centers of the colliding droplet pair separated by a distance d .

For local isotropy, when $d \geq \lambda$ (inertial subrange) the mean square velocity fluctuation is given by Eq. 13.22.

The mean turbulent force \bar{F} is therefore given by

$$\bar{F} = \frac{\pi}{2} \rho \varepsilon^{2/3} d^{8/3} \quad (13.52)$$

For local isotropy, when $d \leq \lambda$ (viscous subrange) the mean square velocity fluctuation is given by Eq. 13.23.

The mean turbulent force \bar{F} is therefore

$$\bar{F} = \frac{\pi}{4} \frac{\rho^2 d^4 \varepsilon}{\mu} \quad (13.53)$$

One can estimate the timescale of film drainage for a colliding drop pair by neglecting the effect of colloidal forces to give,

$$t_{dr} = \frac{h}{dh/dt} = \frac{3\pi\mu d^2}{8\bar{F}} \quad (13.54)$$

For relatively large drop sizes (10–100 μm) and relatively low intensity turbulent flow fields, the timescale of drop collisions (as given by Eq. 13.47.) is much larger than the timescale of coalescence of the drop pair (Eq. 13.54). Consequently, the rate of coalescence can be expressed as,

Rate of coalescence = rate of collision \times coalescence efficiency

13.3.2.2 Models for Coalescence Efficiency

Coulaloglou and Tavlarides (Coulaloglou and Tavlarides, 1977) recognized the probabilistic nature of the coalescence process. They suggested that the force which compresses the drops must act for a sufficient time that the intervening film drains to a critical thickness so that the film ruptures and coalescence will take place. Consequently, the contact time τ between colliding drops must exceed the coalescence time t of the drops. For contact time τ that is normally distributed, the coalescence efficiency is given by,

$$\eta = \exp(-\bar{t}/\bar{\tau}) \quad (13.55)$$

where \bar{t} and $\bar{\tau}$ are averages.

The contact time is estimated by the time two drops of size d_1 and d_2 will stay together and is proportional to the characteristic period of velocity fluctuation of an eddy of size $d_1 + d_2$. For drops in the inertial subrange,

$$\bar{\tau} = \frac{(d_1 + d_2)^{2/3}}{\varepsilon^{1/3}} \quad (13.56)$$

Therefore, the coalescence efficiency can be written as,

$$\eta(d_1, d_2) = \exp\left[-\frac{c\mu\rho\varepsilon}{\gamma^2} \left(\frac{d_1 d_2}{(d_1 + d_2)}\right)^4\right] \quad (13.57)$$

Das et. al. (Das et al., 1987) considered the stochastic nature of drop coalescence by considering the random fluctuations of turbulent force acting on the colliding pair of droplets. They described the force as Gaussian white noise superimposed on a mean turbulent force, i.e.,

$$F = \bar{F} - \delta T_f^{1/2} \zeta(t) \quad (13.58)$$

where δ is the standard deviation of the fluctuating force, T_f is the timescale of force fluctuation and $\zeta(t)$ is white noise. As a result, the drainage equation for the continuous phase film became a stochastic differential equation,

$$\frac{dh}{dt} = \frac{8h}{3\pi\mu d^2} (\bar{F} - \delta T_f^{1/2} \zeta(t)) \quad (13.59)$$

Because of the random nature, the thickness of the draining film will be random thus reaching the critical film thickness of rupture at different times. Das et al. (Das et al., 1987) formulated the Fokker Planck equation corresponding to the above stochastic equation to obtain the mean coalescence time of the drop pair in terms of the characteristics of the turbulent random force. As expected, the average coalescence time was smaller (larger coalescence rate) for larger turbulent force. Interestingly, their model predicted higher coalescence efficiency for higher continuous phase viscosity. Muralidhar et al. (Muralidhar et al., 1988) extended this analysis to band limited noise and considered both nondeformable and deformable colliding drop pair. When the ratio of the characteristic time of force fluctuation and timescale of film drainage becomes large, the turbulent force can be considered to be a random variable and Coualaglou and Tavlarides (Coualaglou and Tavlarides, 1977) analysis is then applicable for the prediction of coalescence frequency.

For sufficiently small drop sizes (0.1 to a few μm) and high-intensity turbulent flow fields, the timescales of collision and coalescence are comparable. Therefore, the rate of coalescence cannot be expressed by collision efficiency. Narsimhan (Narsimhan, 2004) visualized drop coalescence as consisting of two steps, namely, formation of a doublet due to drop collisions, followed by drop coalescence due to rupture of thin liquid film separating the drops. The evolution of number concentration is given by,

$$\frac{dn_1}{dt} = -k_1 n_1^2 + k_d n_d \quad (13.60)$$

$$\frac{dn_d}{dt} = k_1 n_1^2 - (k_d + k_2) n_d \quad (13.61)$$

$$\frac{dn_c}{dt} = k_2 n_d \quad (13.62)$$

where n_1 , n_d and n_c are the number concentration per unit volume of the monomer, the doublet and coalesced droplet respectively, k_1 is the rate constant for the formation of doublet, k_d is the rate of dissociation of the doublet and k_2 is the rate of coalescence of the doublet. These have to be solved with the initial condition,

$$t = 0, \quad n_1 = n_0, \quad n_d = 0, \quad n_c = 0 \quad (13.63)$$

The rate constant k_1 for the formation of doublet can be taken as the rate constant for the rate of collisions as given by,

$$k_1 = \frac{v_c}{n_0^2} \quad (13.64)$$

where v_c , the rate of collisions per unit volume is given by Eqs. 13.44 and 13.45 for inertial and viscous subranges respectively.

Once a doublet is formed, it is subjected to random turbulent force fluctuation. The net turbulent force acting on the doublet at the time of collision is given by (Narsimhan, 2004)

$$F = -\{\bar{F} - \delta T_f^{1/2} \zeta(t)\} \quad (13.65)$$

since the colloidal interaction force at the time of doublet formation is negligible. In the above equation, \bar{F} is the mean turbulent force, δ is the standard deviation, T_f is the timescale of force fluctuation and $\zeta(t)$ is white noise. It is to be noted that the average turbulent squeezing force is attractive. In order for the doublet to separate, the fluctuating force should overcome the mean force \bar{F} . The fluctuating force acting on the doublet is modeled as a poisson process, i.e., a force of magnitude δ (equal to \bar{F}) acts on the doublet at random times with a decay timescale T_f . Narsimhan (Narsimhan, 2004) has evaluated the rate of dissociation of the doublet k_d (inverse of the average dissociation time of the doublet) as,

$$k_d = \frac{1}{0.37T_f} \quad (13.66)$$

T_f being the decay time of turbulent force fluctuation.

The evaluation of the rate of coalescence of drops in a doublet k_2 involves the determination of the average rupture of continuous phase film separating the droplets in the doublet that are exposed to turbulent pressure fluctuations. Narsimhan (Narsimhan, 2004) adopted the same approach as that of Das et al. (Das et al., 1987) and Muralidhar and Ramkrishna (Muralidhar and Ramkrishna, 1986) in expressing the thickness of the film by a stochastic differential equation. Unlike the earlier investigators, Narsimhan (Narsimhan, 2004) also considered colloidal van der Waals and electrostatic interactions between the droplets in the evaluation of film drainage. Therefore, the net force of interaction experienced by the droplet pair is the sum of the turbulent and colloidal forces. Because of the random nature of the turbulent force, the surface to surface distance $h(t)$ can be considered to be a stochastic process. The net interaction force F is given by (Narsimhan, 2004):

$$F = \bar{F} - F_c - \delta T_f^{1/2} \zeta(t) \quad (13.67)$$

where \bar{F} is the mean turbulent force given by Eqs. 13.52) and 13.53 and F_c is the colloidal interaction between the droplets due to Van der Waals and electrostatic forces.

$$F_c = F_{vw} + F_{DL} \quad (13.68)$$

where F_{vw} and F_{DL} refer to the van der Waals and double layer interactions, respectively.

The last term in Eq. 13.67 refers to the turbulent fluctuating force which is explained later in this section. It is to be noted that the hydrodynamic interaction

between the two colliding drops is neglected in this analysis. Such an assumption is indeed reasonable for sufficiently small droplets. The Van der Waals interaction is given by (Hiemenz and Rajagopalan, 1997)

$$F_{VW} = -\frac{A_H R_1 R_2}{6h^2 (R_1 + R_2)} \quad (13.69)$$

where A_H is the Hamaker constant.

Some surfactants are ionic; all proteins have acidic ($-\text{COOH} \rightleftharpoons \text{COO}^- + \text{H}^+$) and basic ($\text{NH}_2 + \text{H}^+ \rightleftharpoons \text{NH}_3^+$) groups therefore are capable of ionized. Such charged molecules adsorbed at the interface forms a charged layer at the oil-liquid interface. This charged layer results in an electrical double layer near the droplet surface. When two droplets move to each other, the potential between the double layers overlap resulting repulsive force to prevent the two droplets getting closer (Hiemenz and Rajagopalan, 1997). A schematic of the double layer and potential profile is shown in Fig. 13.10.

The electrostatic force of interaction F_{FP} per unit area between two plates separated by a distance h is then given by (Chan et al., 1980),

$$F_{FP} = 2kTn_o [\cosh Y_m - 1] \quad (13.70)$$

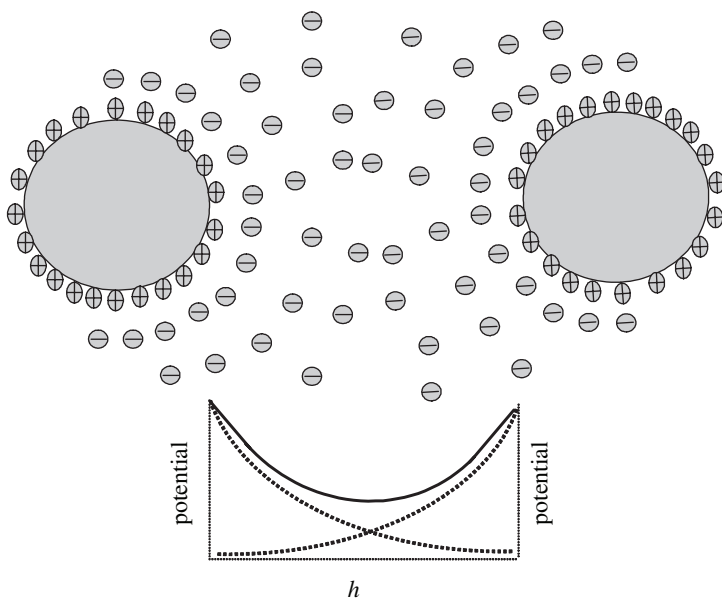

Fig. 13.10 A Schematic of electrical double layer and the potential profile between two charged droplets

where Y_m is the dimensionless midpoint potential defined as,

$$Y_m = \frac{ze\psi_m}{kT} \quad (13.71)$$

In the above equation, z is the valence number of the electrolyte, e is the elementary charge and ψ_m is the midpoint potential which is to be obtained from the solution of Poisson Boltzmann equation.

Using Derjaguin approximation (Hiemenz and Rajagopalan, 1997), the interaction force $F_{DL}(h)$ between two droplets of radius R separated by a surface to surface distance h can be obtained by integration to give,

$$F_{DL}(h) = \pi R \int_h^\infty F_{FP}(x) dx \quad (13.72)$$

Narsimhan (Narsimhan, 2004) has analyzed the film drainage accounting for interdroplet turbulent and colloidal forces to evaluate the mean rupture time of the film and hence the rate of coalescence k_2 (inverse of the mean rupture time). In addition, his analysis also gave the second moment of rupture time distribution. The predicted average drop coalescence time was found to be smaller for larger turbulent energy dissipation rates, smaller surface potentials, larger drop sizes, larger ionic strengths and larger drop size ratio of unequal size drop pair. The predicted average drop coalescence time was found to decrease whenever the ratio of average turbulent force to repulsive force barrier becomes larger. The calculated coalescence time distribution was broader with a higher standard deviation at lower energy dissipation rates, higher surface potentials, smaller drop sizes and smaller size ratio of unequal drop pair. The variation of average coalescence time with energy dissipation rate is shown in Fig. 13.11.

The average coalescence time decreases exponentially as the energy dissipation rate increases. The ratio of the average turbulent force to the colloidal barrier force versus energy dissipation rate is also shown in the same figure. It is interesting to note that the coalescence time decreases dramatically as this ratio increases. The coalescence time distribution (see Fig. 13.12) becomes broader with a larger standard deviation at lower turbulent intensity. The average coalescence time was found to increase dramatically (see Fig. 13.13) with the surface potential. For example, the average coalescence time increases from $\sim 10^{-5}$ to $\sim 10^3$ s as the surface potential increases from 35 to 55 mV. This behavior is due to the increase in the colloidal force barrier due to an increase in the electrostatic repulsion. Similarly, the average coalescence time was found to decrease with an increase in ionic strength (see Fig. 13.14) as a result of smaller electrostatic repulsion caused by the compression of the double layer. The model predictions of average coalescence rate constants for tetradecane-in-water emulsions stabilized by sodium dodecyl sulphate (SDS) in a high pressure homogenizer agreed fairly well with the values inferred from experimental data as reported by Narsimhan and Goel (Narsimhan and Goel, 2001) at different homogenizer pressures and SDS concentrations (Fig. 13.15).

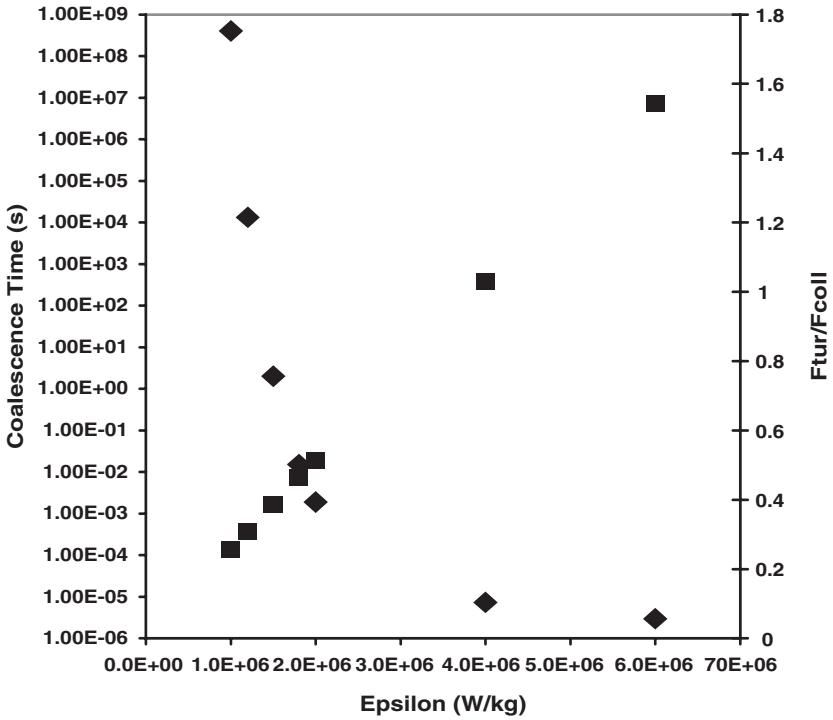

Fig. 13.11 The coalescence time as a function of energy dissipation (Narsimhan, 2004) ◆ Coalescence time; ■ F_{tur}/F_{coll} , where F_{tur} and F_{coll} refer to average turbulent and colloidal forces between drops respectively

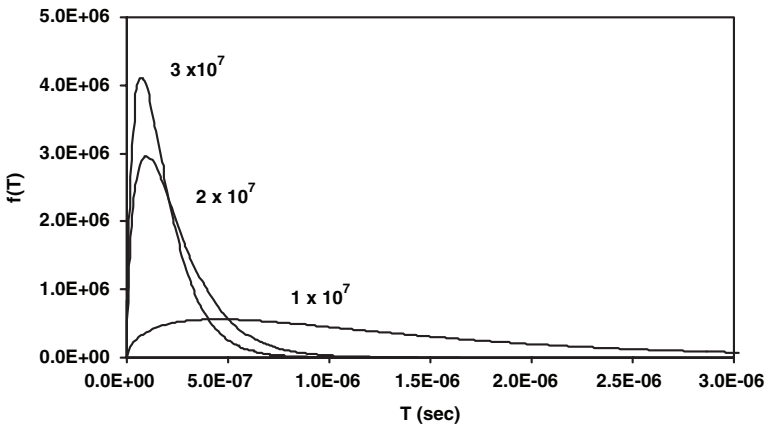

Fig. 13.12 The coalescence time distribution as a function of turbulent density (Narsimhan, 2004)

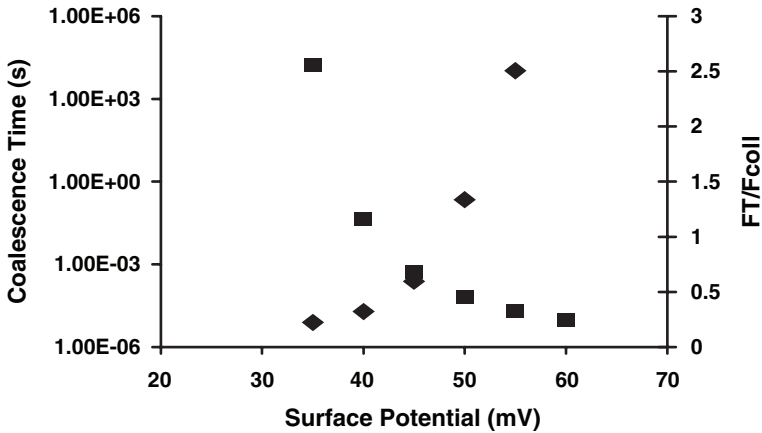

Fig. 13.13 The average coalescence time as a function of surface potential (Narsimhan, 2004) ■ Coalescence time; ♦ F_T/F_{coll} , where F_T and F_{coll} refer to average turbulent and colloidal forces between drops respectively

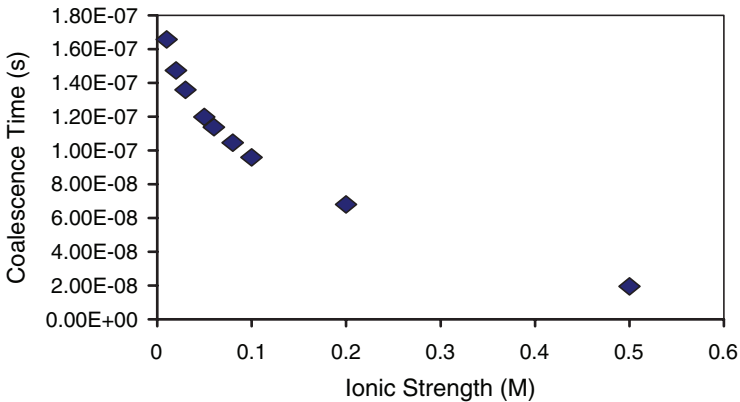

Fig. 13.14 The average coalescence time as a function of ionic strength (Narsimhan, 2004)

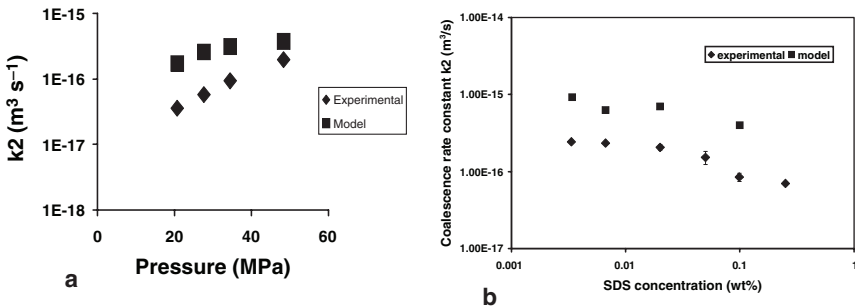

Fig. 13.15 Comparison of predicted and experimental drop coalescence rate constants in a high pressure homogenizer. The model predictions are made for (a) different homogenizer pressures $\bar{R} = 1.951 \times 10^{-7} m$, $\sigma = 3.03 \times 10^{-8} m$, $I = 0.05$, $\epsilon = 7.526 \times 10^7 W / kg$, $\psi_0 = 63.9 mV$ ♦ experimental; ■ model prediction. (b) different SDS concentrations, $\bar{R} = 2.32 \times 10^{-7} m$, $\sigma = 3.203 \times 10^{-8} m$, $I = 0.1$, $\epsilon = 4.82 \times 10^7 W / kg$ ♦ experimental; ■ model prediction. (Narsimhan, 2004)

13.3.3 Role of Surfactants and Proteins on Emulsion Formation

Surfactants and proteins reduce interfacial tension by adsorbing onto the oil-water interface thereby reducing the energy required for emulsion formation. More importantly, the surfactants prevent drop coalescence by various mechanisms thus providing shelf life to such systems. The reduction in interfacial tension is denoted as the surface (interfacial) pressure π defined as,

$$\pi = \gamma_0 - \gamma \quad (13.73)$$

where γ_0 and γ refer to the interfacial tension of pure oil-water interface and interface with adsorbed surfactant respectively. Typical variation of interfacial tension with bulk concentration is shown for different types of surfactants and proteins in Fig. 13.16. As can be seen from the figure, small molecular weight surfactants are more efficient in lowering the interfacial tension than proteins and are therefore necessary in food formulations. The surface pressure can be as high as 50 mN/m (interfacial tension as low as 22 mN/m) for surfactants. Proteins, however, do not reduce the interfacial tension by more than 20 mN/m. As will be discussed later, proteins are essential for providing long term stability. At low concentrations, the surface pressure is given by

$$\pi = \Gamma RT \quad (13.74)$$

where the surface concentration Γ is related to bulk concentration c by Gibbs adsorption equation,

$$\Gamma = - \frac{c}{RT} \frac{d\gamma}{dc} \quad (13.75)$$

At concentrations above critical micelle concentration (cmc), the surface concentration remains constant since the oil-water interface is covered by a monolayer of surfactant.

The adsorption isotherms for macromolecules are much more complicated. Singer (1948) applied a simple lattice model to describe adsorption of macromolecules at interfaces. This model assumed that all the segments of protein molecule adsorbed at the interface in the form of trains. The model is able to predict the isotherm for β casein at air-water interfaces up to a surface pressure of 8 mNm⁻¹. However, the experimental data for the globular proteins BSA and lysozyme do not agree with Singer's model since the proteins do not adsorb in the form of trains. The isotherms at oil-water interface were found to be more expanded compared to Singer's model for both the proteins. Frisch and Simha (1956) allowed for the adsorption of segments in the form of both trains and loops to modify Singer's model to give the following expression for the surface pressure,

$$\frac{\pi a_0}{kT} = \left\{ (y-1)z / 2y(1-x^{-1}) \right\} \ln \left\{ 1 - \left[2p\theta(1-x^{-1})/z \right] \right\} - \ln(1-p\theta) \quad (13.76)$$

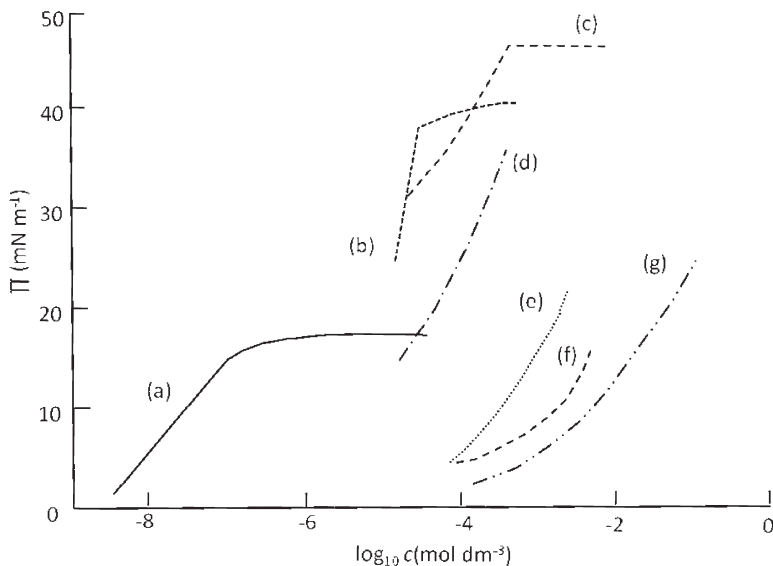

Fig. 13.16 Plot of surface pressure π against logarithm of bulk concentration c for lysozyme and various small-molecule surfactants adsorbing at the oil-water interface. (a) lysozyme (toluene-water), (b) Span 80 (n-octane-water), (c) actylphenoxyethoxyethanol (iso-octane-water), (d) SDS (n-heptane-water), (e) isosorbide monolaurate (n-decane-water), (f) SDS (triglyceride-water), and (g) dodecanoic acid (n-hexane-water). The data are adapted from Fisher and Parker (1988)

where π is the surface pressure, a_0 is the limiting close packed area per segment, k is the Boltzmann constant, T is the temperature, x is the total number of segments of the molecule, z is the coordination number of the lattice and the surface coverage θ is defined as, $\theta = a_0 / a$, a being the average area occupied by a segment, y is the total number of train segments directly in contact with the interface and $p = y / x$.

A globular protein molecule in aqueous solution tends to assume a tertiary structure in which most of the hydrophobic functional groups are buried inside the protein molecule and the hydrophilic functional groups are exposed to the aqueous medium since such a conformation is energetically most favorable. The extent of penetration and subsequent unfolding of the molecule depends on the surface pressure and segment-segment interactions. Uraizee and Narsimhan (Uraizee and Narsimhan, 1991) proposed a two dimensional lattice model which accounts for entropy and enthalpy of mixing of the adsorbed segments at the interface as well as electrostatic interactions because of the presence of electrical double layer in the vicinity of adsorbed layer of protein. They also accounted for the dependence of extent of unfolding of the molecule on the surface concentration. In other words, their model postulated that the adsorbed protein molecule completely unfolded at

very low surface concentrations (or, equivalently, surface pressures) with the extent of unfolding decreasing at higher surface concentrations. Even though this model is more complex and therefore has more parameters; it is more realistic in that it accounts for functional dependence of unfolding on surface pressure as well as electrostatic interactions. This model, however, accounts only for monolayer adsorption of protein at air-water interface. Doullard and Lefebvre (Doullard and Lefebvre, 1990) proposed a phenomenological model accounting both for unfolding of the protein molecule in the first adsorbed layer as well as the formation of a second adsorbed layer. All of these models have many parameters, which limit their applications.

In fact, adsorption kinetics is more important for the efficiency of emulsifiers. As shown in Fig. 13.3, after a droplet rupture occurs, the rate of emulsifier adsorption is a critical factor determining its fate to be stably existing or coalescence. Generally speaking, surfactants adsorb much faster than macromolecules such as proteins. Consequently, surfactants are favorable to breakup droplets. However, protein has its advantage in providing better rheological properties thus emulsion stability (will be discussed later). Adsorption of surfactants is usually diffusion controlled, whose adsorption rate is mainly determined by the bulk concentration. For proteins, molecules have to overcome an energy barrier before it reaches the interface. Electrical double layer is the main source of energy barrier. The surface potential comes from the charges in the adsorbed protein layer and the energy barrier comes from the interaction between the surface charge and the double layer. More charge every single molecule brings, higher energy barrier. When the pH of the solution is close to pI of the protein, the molecules bring fewer charges. This is favorable for protein adsorption. However, close to pI, the surface potential is lower therefore the double layer repulsive force is weaker, which is favorable for droplet coalescence. Consequently, the adsorption rate has to compromise with the emulsion stability.

13.3.3.1 Interfacial Dilatational and Shear Rheology

Interfacial rheology is the relationship between the applied force and the accompanying deformations of an interface. Dilatational deformation refers to area changes while the interface shape is maintained. Shear deformation refers to deformations that result in constant interfacial area while the surface shape is distorted. The relationship between interfacial rheology and the emulsion/foam stability gained much attention in recently years. There is experimental evidence to show that an increase in stability is attained with an increase in interfacial rheology (Bos and Vliet, 2001).

The surfactants and protein molecules at the interface are shown in Fig. 13.17. There are no structural changes in surfactant molecules. For proteins, however, the adsorbed molecules at the interface undergo conformational changes. A flexible protein, e.g., casein, adsorbs to the interface to give an entangled monolayer of flexible chains having sequences of segments in direct contact with the interface ('trains') and others protruding into aqueous phase ('loops' or 'tails') (Dickinson,

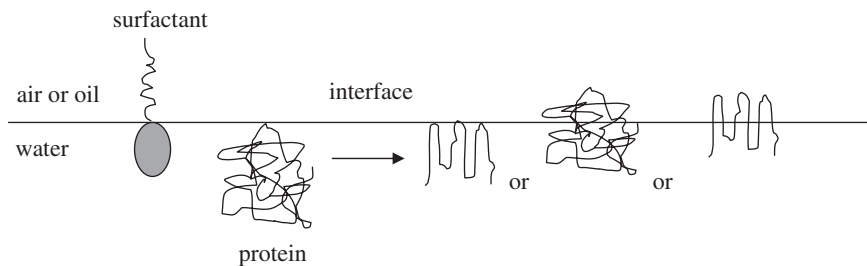

Fig. 13.17 Conformation of a low molecular weight surfactant a protein molecule at a fluid-fluid interface (not to scale). The two drawings on the right apply to oil-water interface (Adapted from Bos and Vliet, 2001)

2001). Hard protein, e.g., β -lactoglobulin, forms a rather dense and thin adsorbed layer (Atkinson et al., 1995). At the time the protein molecules adsorb, the protein layer can be regarded as a closed packed monolayer of deformable particles (Feijter and Bejamins, 1982). Following adsorption, the protein molecules unfold and form a 2-D gel like layer. The intermolecular interaction and covalent crosslink strengthen the gel-like structure. Such a gel-like layer exhibits a viscoelastic behavior.

The interfacial shear viscosities are much higher than those of surfactants. The interfacial shear viscosity of adsorbed protein layers and shear modulus of some proteins are shown in Table 13.3. Among proteins, the globular proteins showed much higher interfacial shear viscosities than flexible proteins. Murray and Dickinson (1996) observed a large time before interfacial shear viscosity starts to increase when the protein concentration is low. This may suggest that a certain level of protein molecules is necessary to form a gel-like layer. Heating results in higher interfacial shear viscosity, probably due to the formation of cross-links between molecules (Dickinson and Matsumura, 1994).

According to Djabbarah and Wasan (Djabbarah and Wasan, 1982), the magnitude of interfacial shear viscosity and elasticity for surfactants at air-water interface is several orders lower than that of dilatational viscosity and elasticity under the same conditions. Unlike shear rheology, the dilatational rheological properties are not sensitive to protein type and molecular structure (Murray and Dickinson, 1996).

13.3.3.2 Mechanisms of Stabilization

Surfactant molecules tend to stabilize the oil-water interface by two distinct mechanisms, namely, (1) Marangoni effect and (2) interfacial rheology. Large globules are stretched in the form of cylindrical threads before they are broken into smaller fragments. In addition, coalescence of two colliding droplets depends on the stability of intervening thin liquid film of continuous phase. Consequently, the ability of surfactant to provide stability to oil-water interface influences both drop breakup as

Table 13.3 Interfacial shear viscosity and shear modulus of various proteins for n-tetradecane-water interface after an adsorption of 24 h (Kokelaar and Prins 1995)

Protein	η^s (mNcs/m)	G^s (mN/m)
β -casein	0.5	0.1
α_{s1} -casein	4.0	0.3
Na-caeinat	7.4	0.6
Gelatine	120	0.6
α -latalbumin	170	— ^a
κ -casein	180	5.0
lyszyme	630	23.0
β -lactoglobulin	1200	—
Myosin	2400	—

^a not determined

well as coalescence. The mobility of oil-water interface with adsorbed layer of surfactant leads to regions of depleted and concentrated surfactants which results in a gradient of interfacial concentration of surfactant. This, in turn, results in a gradient of interfacial tension. This gradient causes an interfacial stress, known as Marangoni stress, that opposes the mobility of the interface thus providing stability as depicted schematically in Fig. 13.18. Of course, the gradient of surfactant interfacial concentration is reduced by (1) spreading of surfactant molecules at the interface due to surface diffusion from regions of higher concentration to regions of lower concentration and (2) adsorption of surfactant from the bulk onto the surface in regions of lower surface concentrations. As pointed out above, proteins provide interfacial shear and dilatational rheology to the oil-water interface. Consequently, adsorption of proteins provides resistance to interfacial mobility due to shear viscosity and resistance to interfacial deformation due to dilatational viscosity.

Consider the stability of an equilibrium thin plane parallel film between two droplets that is stabilized by a mixture of proteins and food emulsifiers. One can characterize the stability of an equilibrium film by analyzing the growth of perturbations of different wavenumbers. It is customary to consider the growth of an asymmetric periodic disturbance of a fixed wavenumber of the form,

$$f(x,t) = f_0 \exp(ikx + \beta t) \quad (13.77)$$

where k is the wavenumber and β is the growth coefficient. The growth coefficient can be evaluated by solving the velocity fields generated by the imposed disturbance subject to the following boundary conditions:

Kinematic boundary condition:

$$v_y(x,h,t) = \frac{\partial f}{\partial t} \quad (13.78)$$

Normal stress boundary condition:

$$p'(h) + \Pi'(h)f_0 + 2\mu_d \left(\frac{dv'_{y,d}(h)}{dy} \right) - 2\mu \left(\frac{dv'_y(h)}{dy} \right) = \sigma f_0 k^2 \quad (13.79)$$

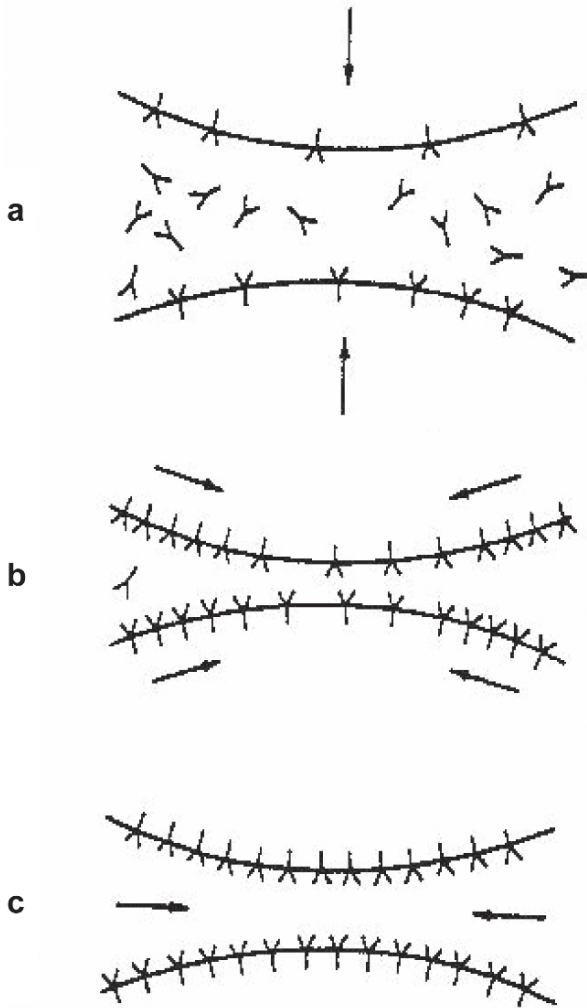

Fig. 13.18 Gibbs-Marangoni effect for two approaching droplets during emulsification. Surfactant molecules are depicted by Y (Király and Vincent 1992)

where the first term is the imposed pressure disturbance, the second term is the change in the disjoining pressure because of imposed disturbance, the third and fourth terms refer to the normal stress at the interface due to flow in the drop and continuous phases respectively.

Shear stress boundary condition:

$$\begin{aligned} \mu \left(\frac{\partial v_y}{\partial x} + \frac{\partial v_x}{\partial y} \right)_{y=h} - \mu_d \left(\frac{\partial v_{y,d}}{\partial x} + \frac{\partial v_{x,d}}{\partial y} \right)_{y=h} = \\ \frac{\partial \gamma}{\partial \Gamma} \frac{\partial \Gamma}{\partial x} + \int_{-\infty}^t (G_d(t-t') + G_s(t-t')) \frac{\partial^2 v_x^0}{\partial x^2} dt' \end{aligned} \quad (13.80)$$

Where the first two terms on the left hand side refer to the shear stress at the interface due to flow in continuous and dispersed phases respectively, the first term on the right hand side is the Marangoni stress and the second term is the stress due to interfacial dilatational and shear rheology. In the above equation, $G_s(t)$ and $G_d(t)$ refer to the surface shear and surface dilatational relaxation modulus respectively. For a Maxwell model, they are given by,

$$G_d(s) = \frac{\kappa}{\lambda_d} \exp\left(-\frac{s}{\lambda_d}\right) \quad (13.81)$$

$$G_s(s) = \frac{\mu_s}{\lambda_s} \exp\left(-\frac{s}{\lambda_s}\right) \quad (13.82)$$

where κ and μ_s are dilatational and shear viscosities respectively. λ_d and λ_s are relaxation times defined as

$$\lambda_d = \frac{\kappa}{g_d} \quad (13.83)$$

$$\lambda_s = \frac{\mu_s}{g_s} \quad (13.84)$$

where g_d and g_s are dilatational and shear elasticity respectively. In order to evaluate the Marangoni stress, one needs to solve for the interfacial concentration gradient from the continuity equation for the surfactant in the bulk and the following surfactant balance at the air-liquid interface,

$$-D \frac{\partial c}{\partial y} \Big|_{y=h} = \frac{\partial}{\partial x} (\Gamma v_x^0) - D_s \frac{\partial^2 \Gamma}{\partial x^2} + \left(\frac{\partial \Gamma}{\partial c} \right)_0 \frac{\partial c}{\partial t} \quad (13.85)$$

where D and Γ are the diffusion coefficient and surface concentration of surfactant respectively, v_x^0 is the interfacial velocity of the film and D_s is the surface diffusion coefficient. If the resistance to adsorption from the subsurface to the surface is much smaller than the diffusional resistance, the subsurface can be assumed to be in equilibrium with the surface as given by $\left(\frac{\partial \Gamma}{\partial c} \right)_0$.

Narsimhan and Wang (Narsimhan and Wang, 2005) have solved for the growth coefficient of imposed disturbance as a function of wavenumber for different interfacial

viscoelasticity of a foam film. Typical plots of β versus k are shown in Fig. 13.19. β_{\max} for a mobile interface is the largest, while that for an immobile interface is the smallest. β_{\max} increases with decreasing interfacial rheological properties. This shows that rheological properties increased the film stability. Effects of λ_d and λ_s are shown in Fig. 13.20. λ_d and λ_s also have symmetric position in equations, therefore only one of them (denoted as λ) is varied here. From Fig. 13.20, for any specified μ_s and κ , when λ is large enough, the film behaves as that with a mobile interface. For intermediate range of λ , β_{\max} decreases with the decrease of λ . When λ decreases to a small enough value, β_{\max} decrease to a constant value and is no longer dependent on λ . This intermediate range shifts to smaller λ when κ and μ_s decrease.

In order to ascertain the importance of surface shear and dilatational rheological properties on stability of protein stabilized film, calculations of β_{\max} for different film thickness was carried out for a film stabilized by β -lactoglobulin at pH 7 and ionic strength of 0.02. Based on high frequency limits of these surface shear and dilatational rheological properties and under the assumption of negligible Marangoni effect, β_{\max} was calculated for different film thicknesses and compared with the corresponding values for mobile and immobile films (see Fig. 13.21). Figure 13.21 also gives the relative values of β_{\max} for different film thickness. It is interesting to note that β_{\max} values lie between the mobile and immobile limits for film thickness range of 100–2000 nm thereby indicating that the effects of surface rheological properties on film stability is indeed important. Also, for very large film thickness (>2000 nm), the film can be considered to be mobile, whereas for very thin films (<100 nm), the film can be considered to be immobile.

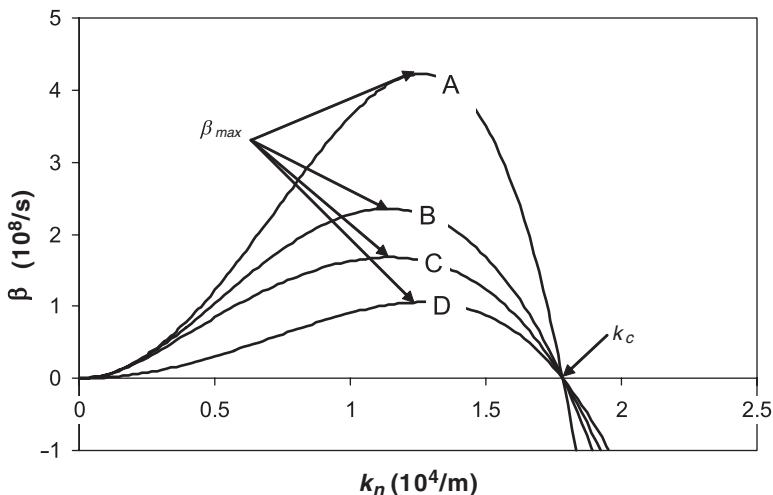

Fig. 13.19 Growth coefficient versus wave number at a given film thickness. A–D are for mobile, viscoelastic ($\kappa = 0.1 N \times s/m$), viscoelastic ($\kappa = 1 N \times s/m$) and immobile interface respectively. Parameters for viscoelastic interface are: $\mu_s = 0.4 N \times s/m$, $\lambda_d = 10 s$ and $\lambda_s = 4 s$; other parameters are $\mu = 10 Pa \times s$, $\gamma = 50 mN/m$, $A = 10^{-20} J$ and $h = 10^{-7} m$ (Narsimhan and Wang, 2005)

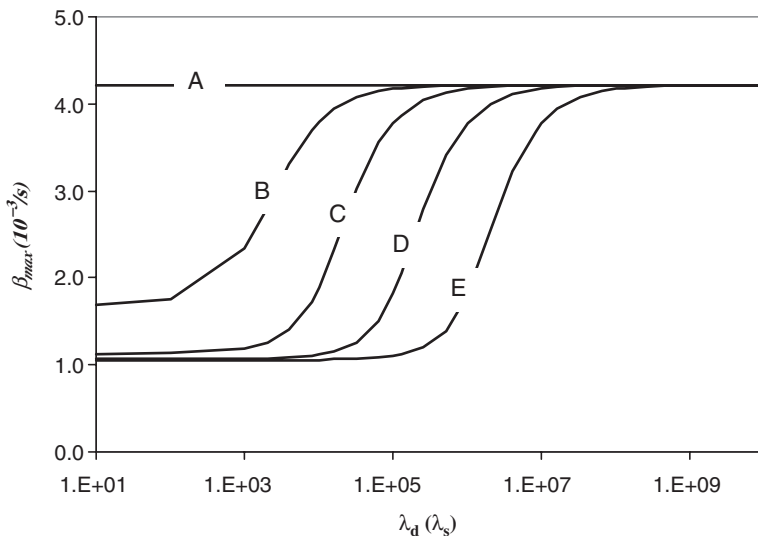

Fig. 13.20 β_{\max} versus λ_d for different κ and μ_s . Parameters are $\mu = 5 P \times as$, $\gamma = 50 mN / m$, $A = 10^{-20} J$ and $h = 10^{-7} m$. κ and μ_s values for different curves are **A**: 0 and 0; **B**: 1×10^{-3} and $4 \times 10^{-4} N \times s / m$; **C**: 1×10^{-2} and $4 \times 10^{-3} N \times s / m$; **D**: 1×10^{-1} and $4 \times 10^{-2} N \times s / m$; and **E**: 1 and $0.4 N \times s / m$; respectively (Narsimhan and Wang 2005)

13.4 Example of Emulsion Based Food Products

Emulsion exists extensively in food. The first food people eat upon birth, mammalian milk, is an emulsion. Homogenized milk with high pressure valve homogenizer was introduced in 1900 (Dickinson, 1992). Nowadays, many food mixtures were made into emulsions to improve mouthfeel, texture, palatability, shelf life, and appearance. Becher (1985) summarized typical food emulsions with brief descriptions. In the following most important food emulsions are discussed.

13.4.1 Mayonnaise and Salad Dressing

Mayonnaise is a typical oil-in-water emulsion with high oil content. Corran (Becher, 2001) has given a complete discussion about the production of mayonnaise. The typical formula for a commercial mayonnaise is given in Table 13.4.

For a commercial product, flavoring and/or coloring materials are also added. Among the above ingredients, egg yolk is most critical for the stability of product. However, egg yolk is not a satisfactory emulsifier. The surface active components, lecithin and cholesterol, are only 11.5% of total weight. Lecithin is a

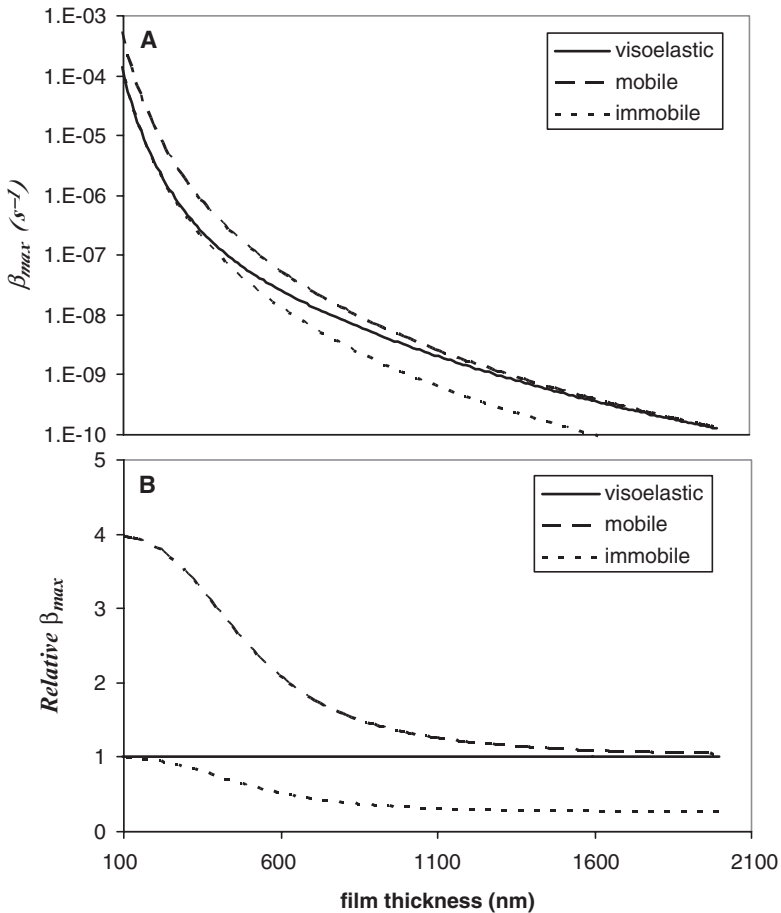

Fig. 13.21 (A) Actual and (B) relative maximum growth coefficient (normalized by maximum growth coefficient for viscoelastic case) of a β -lactoglobulin stabilized thin film at a solid surface. $A = 10^{-20} J$, $\gamma = 50 mN / m$. For the actual viscoelastic surface, $\kappa_s = 12.9 mN \times s / m$, $G_s = 18.8 mN / m$, $\mu_s = 3.9 mN \times s / m$, $\eta = 103 mN / m$ (Narsimhan and Wang, 2005)

Table 13.4 Typical formula of commercial mayonnaise (Becher, 2001)

Ingredient	Percentage
Oil	75.0
Salt	1.5
Egg yolk	8.0
Mustard	1.0
Water	3.5
Vinegar (6% acetic acid)	11.0

good oil-in-water emulsifier while cholesterol is an effective water-in-oil emulsifier. If the lecithin/cholesterol ratio is low, e.g., 8:1 for a 50–50 oil-water emulsion, the emulsion may be inversed to water-in-oil. In natural egg yolk, the lecithin/cholesterol ratio is around 6.7:1. Therefore, mustard, which is a fine solid, is added to stabilize the mixture (Becher, 2001). Other factors, such as phase volume, mixing method, water quality, and viscosity also have influence on the product (Becher, 2001).

Salad dressing is another emulsion stabilized by egg yolk. The most difference from mayonnaise is the much lower oil content, which is usually around 45%. Additional stabilizer such as gums may also in presence. Compared to mayonnaise, stable emulsions of salad dressing is easier to obtain by any technique (Becher, 2001).

13.4.2 Margarine and Table Spreads

Margarine was invented in 1869 as a butter substitute (Andersen and Williams 1965; Dickinson, 1992). It is a water-in-oil emulsion with high content of oil. FDA standards of identity require the fat content no less than 80%. The water phase consists of water, salt thickeners, and *etc.* The oil phase consists of partially hydrogenated vegetable oil, or some times animal fat (Borwanker and Buliga, 1990) In modern times, marine oils, in particular oils from whale, are also used (Becher, 2001).

Detailed information about margarine and table spreads is discussed in Chap. 11.

13.4.3 Beverages

Beverage emulsions are different from most of food emulsions in that the dispersed phase fraction is very small. The dispersed phase is the vehicle to carry flavors, colors and other oil-soluble ingredients (Becher, 1985). This type of emulsions is difficult to prevent creaming because of the density difference between the dispersed and continuous phase. Viscosity of continuous phase and droplet size distribution also have influence on creaming (Chilton and Laws, 1980).

13.5 Guidelines for Selection of Food Emulsifiers

13.5.1 Regulatory of Emulsifiers

Emulsifiers are regulated by FDA in United States. Two groups of emulsifiers are classified: GRAS (generally recognized as safe) and Regulated Direct Food Additives. The former may be used in any nonstandardized food product at any

level necessary to obtain the desired technical effects. The latter may be regulated similarly to GRAS, but more often, they are strictly regulated in use, such as the methods of manufacture, analytical constants, type of food in which they are used, and maximum concentration.

13.5.2 *Classification of Emulsifiers*

There are many types of surfactants available to stabilize emulsions. Some classifications of surfactants has been developed based on the physicochemical properties, such as Bancroft's rule, HLB number, and molecular geometry (Davies, 1994; Dickinson and Hong, 1995; Bergenstahl, 1997). Among them HLB number is most extensively used.

HLB (Hydrophile-lipophile balance) is an empirical scale based on the relative percentage of hydrophilic and hydrophobic functional groups in the surfactant molecule (Griffin, 1949). Surfactants with HLB numbers in the range 4–6 are suitable for stabilizing water-in-oil emulsions, whereas those with HLB numbers in the range of 8–18 are suitable for oil-in-water emulsions. HLB values of some commonly used food emulsifiers are given in Table 13.5. A group contribution technique (Davies, 1957) for evaluating HLB of surfactant molecules assigns group numbers to different functional groups in the following equation,

Table 13.5 HLB values for some food emulsifiers

Emulsifier	HLB
Sorbitan tristearate (Span 65)	2.1
Glycerol monostearate	3.8
Sorbitan monooleate (Span 80)	4.3
Propylene glycol monolaurate	4.5
Succinic acid ester of monoglycerides	5.3
Sorbitan monopalmitate (Span 40)	6.7
Sorbitan monolaurate (Span 20)	8.6
Diacetyl tartaric acid ester of monoglycerides	9.2
Polyoxyethylene sorbitan monostearate (Tween 60)	14.9
Polyoxyethylene sorbitan monopalmitate (Tween 40)	15.6
Polyoxyethylene sorbitan monolaurate (Tween 20)	16.7
Sodium oleate	18.0
Sodium steroyl-2-lactylate	21.0

$$HLB = 7 + \sum_i n_H(i) - \sum_j n_L(j) \quad (13.86)$$

where $n_H(i)$ and $n_L(j)$ are the group numbers of hydrophilic group i and hydrophobic group j , respectively. The group numbers of different functional groups are given in Table 13.6 (Davies, 1957).

HLB concepts does not account for the fact that functional properties of a surfactants strongly depends on temperature and solution conditions (Davies, 1957). In reality, some surfactants are able to stabilize oil-in-water emulsions at one temperature while to stabilize water-in-water emulsions at other temperatures.

In food industry, proteins are also used as emulsifiers. Milk proteins, because of their high surface activity, are most extensively used. The two main classes of milk proteins are the caseins and whey proteins. β -casein and α_{s1} -casein are the most important components of casein proteins. β -casein is a flexible linear amphiphilic polyelectrolyte with a molecular weight of 24 kDa. At neutral pH, a β -casein molecule carries a net charge of $-15e$. It has little ordered secondary structure and no intramolecular covalent crosslinks. The hydrophobic and hydrophilic residues are nonuniformly distributed, which make the molecule has amphiphilic structure like a water soluble surfactant (Dickinson, 2001). α_{s1} -casein has a slightly smaller molecular weight but much higher net charge ($-22 e$) at neutral pH. Its hydrophilic and hydrophobic residues are more randomly distributed (Dickinson and Matsumura, 1994). Whey protein consists of several globular proteins, such as β -lactoglobulin and α -lactalbumin. β -lactoglobulin has molecular weight of about 18.4 kDa from 162 amino acid residues. There are 5 cysteine residue with 2 intramolecular disulfide bonds and 1 free sulfhydryl group. At neutral pH, the net charge is $-15e$ (Cornec et al., 1999). In native state, the molecule is folded intramolecularly so that most of its hydrophobic residues are buried with the globular structure. The structure of β -lactoglobulin strongly depends on pH and temperature. It forms dimers at pH 7, while exists as monomers below pH 3.5 or above pH 7. Heating also changes the structure. When the heating temperature is lower at which the disulfide bonds are intact, the molecule may unfold and refold reversibly. However, when the heating temperature is high, the denaturation occurs and the molecules become more disordered (Swaisgood, 1996).

Table 13.6 Hydrophilic group numbers

Group	n_H	Group	n_H
$-\text{SO}_4\text{Na}$	38.7	$-\text{COOH}$	2.1
$-\text{COOK}$	21.1	$-\text{H}(\text{free})$	1.9
$-\text{COONa}$	19.1	$-\text{O}-$	1.3
Tertiary amine	9.4	$-\text{OH}$	0.5
Ester(sorbitan)	6.8	$-(\text{CH}_2-\text{CH}_2-\text{CH}_2-\text{O})-$	0.33
Ester (free)	2.4	$-(\text{CH}_2-\text{CH}_2-\text{CH}_2-\text{CH}_2-\text{O})-$	-0.15^a

^aThe negative value denotes the group is lipophilic

Acknowledgment We would like to acknowledge Ms. Linda Indrawati for her help in the preparation of this chapter.

References

- Andersen, J. A. C. and P. N. Williams (1965). *Margarine*. London, Pergamon Press.
- Atkinson, P. J., E. Dickinson, et al. (1995). "Neutron reflectivity of adsorbed beta-casein and beta-lactoglobulin at the air/water interface." *J. Chem. Soc. Faraday Trans.* **91**: 2847–2854.
- Barthes-Biesel, D. and A. Acrivos (1973). "Deformation and burst of a liquid droplet freely suspended in a linear shear field." *J. Fluid Mech.* **61**: 1–21.
- Bartok, W. and S. G. Mason (1957). "Particle motions in sheared suspensions. V. Rigid rods and collision doublets of spheres." *J. Colloid Interface Sci.* **12**: 243–262.
- Becher, P. (1985). *Encyclopedia of Emulsion Technology*, Vol. 2, Marcel Dekker, New York.
- Becher, P. (2001). Emulsion applications. *Emulsions: Theory and Practice*,_ Washington DC, Oxford University Press: 429–459.
- Bergenshtahl, G. (1997). Physicochemical aspects of emulsifier functionality. *Food emulsifier and their applications* (Eds. G. L. Hasenhuetti and R. W. Hartel). New York, Chapman and Hall.
- Borwanker, R. P. and G. S. Buliga (1990). *Food Emulsions and Foams: Theory and Practice*. AICHE Symposium Series.
- Bos, M. A. and T. V. Vliet (2001). "Interfacial rheological properties of adsorbed protein layers and surfactants: A review." *Adv. Colloid Interface Sci.* **91**: 437–471.
- Brennen, J. G., J. R. Butters, et al. (1990). *Food Engineering Operations*. New York, Elsevier Applied Science.
- Calabrese, R. V., T. P. K. Chang, et al. (1986). "Drop breakup in turbulent stirred tank contactors-Part I: effect of dispersed phase viscosity." *AIChE J.* **32**(4): 657–666.
- Chan, D. Y. C., R. M. Pashley, et al. (1980). "A simple algorithm for the calculation of the electrostatic repulsion between identical charged surfaces in electrolyte." *J. Colloid Interface Sci.* **77**: 283.
- Chilton, H. M. and D. R. J. Laws (1980). "Stability of aqueous emulsions of the essential oil of hops." *J. Inst. Brew.* **86**: 126–130.
- Cornec, M., D. Cho, et al. (1999). "Adsorption dynamics of a-lactalbumin and b-lactoglobulin at air-water interfaces." *J. Colloid Interface Sci.* **214**(2): 129–142.
- Coulaloglou, C. A. and L. L. Tavlarides (1977). "Description of interaction processes in agitated liquid-liquid dispersions." *Chem. Eng. Sci.* **32**: 1289–1297.
- Cox, R. G. (1969). "The deformation of a drop in a general time-dependent flow." *J. Fluid Mech.* **37**: 601–623.
- Darling, D. F. and R. J. Birkett (1986). Food colloids in practice. *Food Emulsions and Foams* (Ed. E. Dickinson). London, Royal Society of Chemistry, Burlington House.
- Das, P. K., R. Kumar, et al. (1987). "Coalescence of drops in stirred dispersion. A white noise model for coalescence." *Chem. Eng. Sci.* **42**(2): 213–220.
- Davies, H. T. (1994). "Factors determining emulsion type: Hydrophile–lipophile balance and beyond." *Colloids and Surfaces A: Physicochemical and Engineering Aspects* **91**: 9–24.
- Davies, J. T. (1957). *Gas/liquid and liquid/liquid interface*. Proceedings of International Congress on Surface Activity, London, Butterworth.
- Dickinson, E. (1992). *An Introduction to Food Colloids*. New York, Oxford University Press.
- Dickinson, E. (2001). "Milk protein interfacial layers and the relationship to emulsion stability and rheology." *Colloids Surf. B Biointerfaces* **20**(3): 197–210.
- Dickinson, E. and S. T. Hong (1995). "Influence of water-soluble nonionic emulsifier on the rheology of heat-set protein-stabilized emulsion gels." *J. Agric. Food Chem.* **43**: 2560–2566.
- Dickinson, E. and Y. Matsumura (1994). "Proteins at liquid interfaces: Role of the molten globule state." *Colloids Surf. B Biointerfaces* **3**: 1–17.

- Dickinson, E. and G. Stainsby (1988). Emulsion Stability. *Advances in Food Emulsions and Foams* (Eds. E. Dickinson and G. Stainsby). London, Elsevier Applied Sciences.
- Djabbarah, N. F. and D. T. Wasan (1982). "Dilational viscoelastic properties of fluid interfaces—III Mixed surfactant systems." *Chem. Eng. Sci.* **37**(2): 175–184.
- Douillard, R. and J. Lefebvre (1990). "Adsorption of proteins at the gas-liquid interface: Models for concentration and pressure isotherms." *J. Colloid Interface Sci.* **139**(2): 488–499.
- Feijter, J. A. de. and J. Bejamins (1982). "Soft-particle model of compact macromolecules at interfaces." *J. Colloid Interface Sci.* **90**(1): 289–292.
- Fisher, L. R. and Parker, N. S. (1988). In *Advances in food emulsions and foams* (eds. E. Dickinson and G. Stainsby), p. 53. Elsevier Applied Science, London.
- Flumerfelt, R. W. (1972). "Drop breakup in simple shear fields of viscoelastic fluids." *Ind. Eng. Chem., Fund.* **11**: 312.
- Frisch, H. L. and Simha, R. (1956), *J. Chem. Phys.*, **24**, 652.
- Gopal, E. S. R. (1968). Principles of emulsion formation. *Emulsion Science*. P. Sherman. London, Academic Press.
- Griffin, W. C. (1949). "Classification of surface-active agents by 'HLB'." *J. Soc. Cosmet. Chem.* **1**: 311.
- Hiemenz, P. C. and R. Rajagopalan (1997). The Electrical double layer and double-layer interactions. *Principles of Colloid and Surface Chemistry*. New York, Marcel Dekker: 499–533.
- Hinze, J. O. (1955). "Fundamentals of the hydrodynamic mechanism of splitting in dispersion processes." *AIChE J.* **1**(3): 289–295.
- Kandori, K. (1995). Applications of microporous glass membranes: Membrane emulsification. *Food Processing: Recent Developments* (Ed. A. G. Gaonkar). Amsterdam, Elsevier: 113–142.
- Karam, H. J. and J. C. Bellinger (1968). "Deformation and breakup of liquid droplets in a simple shear field." *Ind. Eng. Chem. Res.* **7**(4): 576–581.
- Kiraly, Z. and B. Vincent (1992). "The synthesis and characterization of Poly(ethylene oxide)-b-Polydimethylsiloxane diblock copolymers." *Polym. Int.* **28**: 139–150.
- Kokelaar, J. J. and A. Prins (1995). "Surface rheological properties of bread dough components in relation to gas bubble stability." *J. Food Sci.* **22**: 53–61.
- Levich, V. G. (1962). *Physicochemical Hydrodynamics*. Englewood Cliffs, N. J., Prentice Hall.
- Lobo, L. and A. Sverika (1997). *A unique method to measure coalescence occurring during homogenization*. Proceedings of Second World Conference on Emulsions.
- McCarthy, W. W. (1964). "Ultrasonic emulsification" *Drug Cosmet. Ind.* **94**(6): 821–824.
- McClements, D. J. (1999). *Food Emulsions: Principles, Practice and Techniques*. Boca Raton, FL, CRC Press.
- Mohan, S. and G. Narsimhan (1997). "Coalescence of protein-stabilized emulsions in a high pressure homogenizer." *J. Colloid Interface Sci.* **192**: 1–15.
- Muralidhar, R. and D. Ramkrishna (1986). "Analysis of droplet coalescence in turbulent liquid-liquid dispersions." *I&EC Fundamentals* **25**: 554–560.
- Muralidhar, R., D. Ramkrishna, et al. (1988). "Coalescence of rigid droplets in a stirred dispersion- II. Band-limited force fluctuations." *Chem. Eng. Sci.* **43**: 1559–1568.
- Murray, B. S. and E. Dickinson (1996). "Interfacial rheology and the dynamic properties of adsorbed films of food proteins and surfactants." *Food Sci. Technol. Int.* **2**: 131–145.
- Narsimhan, G. (1992). Emulsions. *Physical Chemistry of Foods* (Eds. H. G. Schwartzberg and R. W. Hartel). Marcel Dekker, New York.
- Narsimhan, G. (2004). "Model for drop coalescence in a locally isotropic turbulent flow field." *J. Colloid Interface Sci.* **272**: 197–209.
- Narsimhan, G. and P. Goel (2001). "Drop coalescence during emulsion formation in a high pressure homogenizer for tetradecane-in-water emulsion stabilized by sodium dodecyl sulphate." *J. Colloid Interface Sci.* **238**: 420–432.
- Narsimhan, G., J. P. Gupta, et al. (1979). "Model for transitional breakage probability of droplets in agitated lean liquid-liquid dispersions." *Chem. Eng. Sci.* **34**(2): 257–265.
- Narsimhan, G., G. Neijfelt, et al. (1984). "Breakage functions of droplets in agitated liquid-liquid dispersions." *AIChE J.* **30**(3): 457–467.

- Narsimhan, G., D. Ramkrishna, et al. (1980). "Analysis of drop size distributions in lean liquid-liquid dispersions." *AIChE J.* **26**(6): 991–1000.
- Narsimhan, G. and Z. Wang (2005). "Stability of thin stagnant film on a solid surface with a viscoelastic air-liquid interface." *J. Colloid Interface Sci.* **291**(1): 296–302.
- Phipps, L. W. (1985). *The High Pressure Dairy Homogenizer*. Reading, England, The National Institute for Research in Dairy.
- Robins, M. M. and D. J. Hibberd (1998). Emulsion flocculation and creaming. *Modern Aspects of Emulsion Science* (Ed. B. P. Binks). The Royal Society of Chemistry.
- Rumscheidt, F. D. and S. G. Mason (1961a). "Particle motions in sheared suspensions. XI. internal circulation in fluid droplets (experimental)." *J. Colloid Interface Sci.* **16**: 210–237.
- Rumscheidt, F. D. and S. G. Mason (1961b). "Particle motions in sheared suspensions XII. Deformation and burst of fluid drops in shear and hyperbolic flow." *J. Colloid Interface Sci.* **16**: 238–261.
- Sathyagal, A. N., D. Ramkrishna, et al. (1996). "Droplet breakage in stirred dispersions. Breakage functions from experimental drop size distributions." *Chem. Eng. Sci.* **51**(9): 1377–1391.
- Singer, S. J. (1948), *J. Chem. Phys.*, **16**: 812.
- Swaisgood, H. E. (1996). Characteristics of Milk. *Food Chemistry* (Ed. O. R. Fennema). New York, Marcel Dekker, Inc: 841–878.
- Taylor, G. I. (1932). "The viscosity of a fluid containing small drops of another fluid." *Proc. Roy. Soc. (London)* **A138**: 41–48.
- Taylor, G. I. (1934). "The formation of emulsions in definable fields of flow." *Proc. Roy. Soc. (London)* **A146**: 501–526.
- Torza, S., R. G. Cox, et al. (1972). "Particle motions in sheared suspensions. XXVII. Transient and steady deformation and burst of liquid drops." *J. Colloid Interface Sci.* **38**(2): 395–411.
- Tsaine, L., P. Walstra, et al. (1996). "Transfer of oil between emulsion droplets." *J. Colloid Interface Sci.* **184**: 378–390.
- Uraizee, F. and G. Narsimhan (1991). "A surface equation of state for globular proteins at the air-water interface." *J. Colloid Interface Sci.* **146**(1): 169–178.
- Walstra, P. (1983). Formation of emulsions. *Encyclopedia of Emulsion Technology* (Ed. P. Becher). New York, Marcel Dekker: 1.
- Walstra, P. and P. E. A. Smulders (1998). Emulsion formation. *Modern aspects of emulsion science* (Ed. B. P. Binks). The Royal Society of Chemistry: 56–99.

Chapter 14

Forecasting the Future of Food Emulsifiers

Gerard L. Hasenhuettl

In many areas, the first cut at forecasting future trends involves observing the past, and then extrapolating the data points into the future. For example, the consumption of food ingredients can be correlated with population and personal income growth. Forecasts of consumer tastes are much more difficult. Scientific and technical innovation generally follows an S-curve. Radical (discontinuous) innovation requires a jump to a new S-curve. Humans are generally disinclined to undertake radical experiments with their food consumption (with the possible exception of fad diets for weight loss). Current controversies surrounding genetically modified plants, cloned animals, and irradiation are prominent examples. Nevertheless, radical innovations in nutrition and technology do occur and stimulate changes in food consumption. Recent examples include the glycemic index and adverse health studies for trans fatty acids.

Food emulsifiers exert several technical effects (see Table 1.1), and can be useful tools to address these new trends. This chapter will discuss some trends that may impact on demands for new and modified emulsifier compositions and applications.

14.1 Globalization of the Food Industry

The food industry has historically been multi-domestic. Local tastes, national food regulations, and the cost of shipping have contributed to localization pressure. However, some strong counter-trends have begun to exert pressures toward globalization. Global communication, industry consolidation, income growth in developing countries, and international travel are a few of these forces. Alcoholic beverages, gourmet foods, and canned meats have been shipped internationally for decades. More recently, confectionery products have been shipping globally.

Shipment of food emulsions and dispersions can be problematic for their chemical, microbiological, and physical stability. For example, vibration may cause separation of an emulsion. The separated aqueous phase may serve as a medium for microbial growth. Many of the developing countries do not yet have widespread refrigeration for small stores and consumers. Food surfactants may help to solve some of these stability problems. Guidance might be obtained from the cosmetic and pharmaceutical industries, since they have developed emulsion/dispersion products which are shelf stable for several years.

Table 14.1 Functionality of Surfactants in Foods

FUNCTION	SURFACTANT(S)	FOOD(S)
Emulsification	Polysorbate 60	O/W Emulsions - Salad Dressings, Mayonnaise
Controlled Demulsification	Monoacylglycerols	W/O Emulsions – Margarine
	Polysorbate 80	Ice Cream
Solubilization	Polysorbate 80, Polyglycerol Esters	Flavor Oils, Pickle brine
Aeration/Whipping	Propylene Glycol & Polyglycerol Esters	Cakes, Whipped Toppings
Viscosity Control	Lecithin, Polyglycerol Polyricinoleate	Chocolate
Dough Strengthening	DATE<, Succinylated Monoacylglycerols	Bread
Anti-staling	Sodium & Calcium Stearoyl Lactylate	Bakery Products
Crystal Inhibition	Oxystearin, Polyglycerol Esters	Salad Oils
Anti-stick Agents	Lecithin	Frying shortenings
Gloss Retention/Bloom Inhibition	Sorbitan Monostearate, Polyglycerol Esters	Compound Confectionery Coatings
Freeze-thaw Stabilization	Sodium Stearoyl Lactylate	Frozen Coffee Whiteners
Clouding Agents	Sucrose Acetate Isobutyrate	Beverages
Anti-spattering Agents	Monoacylglycerols, Lecithin	Margarines & Spreads

As global population continues to expand, food consumption will likewise increase. Arable land will be pressed toward higher yields. Further pressure from development of biofuels, such as ethanol and biodiesel, may be significant. A search for novel and less expensive sources of proteins, fats, and carbohydrates may pose interesting challenges for food product developers. Food surfactants will provide useful tools to optimize the functionality of these novel ingredients.

14.2 Nutritionally Driven Changes in Foods

Nutritional studies concerning diet and health, as well as their counterweight, diet and disease, are continually appearing in the literature, often with conflicting interpretations. Predicting trends in this area can be complex and confusing. There are a few areas where there is broad scientific consensus.

14.2.1 Total, Saturated, and Trans Fat Consumption

Obesity has become a serious problem, if not an epidemic, in developed countries. This is likely the result of increasing personal wealth and increasing availability of high calorie foods, which lead to increased consumption. More sedentary lifestyles

have aggravated the upset in caloric balance (calories consumed > > calories burned). Dietary fat yields approximately 9 cal/g, compared to 4 cal/g for carbohydrates and proteins. Fat is therefore an efficient means for animals and plants to store energy. Development of reduced fat and fat-free products changes the relative phase volumes of lipid and water. This may change the type (W/O - > O/W) and/or stability of the emulsion. Non-lipid fat mimetics are added to restore textural attributes of fat, but may destabilize the system. Flack (1992) suggested that structured surfactants could assume the role of the missing fat. This has been accomplished for some applications and is described in greater detail in Chap. 12. As our knowledge of phase behavior continues to increase, additional applications will be targeted.

The contributing role of saturated fat to coronary artery disease has been studied for more than 50 years. Research demonstrated that diets high in saturated fats significantly increased serum cholesterol (Keys et al., 1965; Hegsted et al., 1965). Removal of highly saturated fats, such as lard, tallow, coconut, palm, and palm kernel oils proceeded at a rapid pace during the 1970s and 80s. Food surfactants were used extensively to provide functionality of the saturated fats. Mensink and Katan (1990) suggested that trans fatty acids also raised cholesterol levels. The issue was hotly debated until Judd (2002) demonstrated that diets high in trans fatty acids simultaneously raised LDL, and lowered HDL cholesterol levels. The Food and Drug Administration responded with regulations to disclose content of trans fatty acids in packaged foods (Federal Register, 2004). Unfortunately, trans fats have been used as substitutes for replacement of saturates. In frying oils, hydrogenation is used to improve oxidative stability, but generates trans isomers. Technologies have now been developed to create trans-free lipids for a number of applications (Kodali and List, 2006; Gunstone, 2006). The future will likely see active research on the use of surfactants to improve the functional and organoleptic properties of trans-free foods.

14.2.2 Low Sugar and Carbohydrate Products

Type II diabetes has been described as an epidemic in some developed countries. People who have this condition must carefully control their weight and carbohydrate intake. Development of the glycemic index (Warshaw et al., 2004) has identified carbohydrates to avoid and some which can be used in moderation. Substances with a high glycemic index values, such as sucrose, cause significant spikes in blood sugar. Starch is broken down into glucose units and needs to be limited. Fibers, such as bran, have low glycemic indices and their consumption should be increased. Reformulation of products to lower sugar and starch can lead to loss of functionality, particularly where carbohydrate/surfactant interactions are important (for example, see Chaps. 4 and 9).

Ingredient suppliers will continue to work with consumer food companies to overcome the challenges of developing desirable products for the growing population of diabetic and pre-diabetic patients. Answers may be found in discovery of

surfactant interactions with novel carbohydrates. Stable heterogeneous formulations may also display interesting organoleptic properties.

14.2.3 Delivery of Nutrition to Special Populations

Progress is continuing in pediatric care of infants born prematurely. Delivery of nutrients to these patients will continue to be a challenging problem. The role of food surfactants in infant nutrition was discussed in Chap. 8.

As life expectancy increases, a population of the elderly with special dietary needs is also increasing (Morley and Thomas, 2007; Singh, 2000). Proper nutrition is essential to prevent degenerative conditions, such as osteoporosis. Sensory receptors associated with taste and olfaction decline with age. In many cases, elderly individuals lose interest in eating, since it is no longer an enjoyable experience. Formulations which enhance flavor release may help address this problem.

Physical activity is a factor that contributes to maintenance of good health. However, proper nutrition is necessary for endurance and muscle development (Driskell, 2007; Kern, 2005). Enhanced nutrition is also necessary to promote repair of damaged muscles and joints. As competitive sports become more demanding, delivery of nutrients to specific areas of the body may be seen as an advantage. Development of performance foods may be modeled after the pharmaceutical industry's use of surfactants to target drugs. Surfactants may prove to be useful tools to achieve these formulations.

14.3 Advances in Science and Technology

Although consumers are reluctant to embrace radical change, progress in science and technologies will undoubtedly influence the design of surfactant systems for food processing. Several areas are of particular interest.

14.3.1 Surfactant Structure and Phase Behavior

As described in Chap. 1, molecular structure determines the behavior of surfactants in food systems. Israelachvili (1992) correlated polymorphic structure to a critical packing parameter. The phase behavior of surfactants is described in detail in Chap. 6. The major difficulty in defining structure/functionality relationships is the occurrence of complex surfactant mixtures. This is particularly true for polyglycerol esters, sucrose esters, and polysorbates.

Dramatic progress in chromatography and mass spectroscopy (Byrdwell, 2005; Han and Gross, 2005; Larsen et al., 2005; Mossoha, 2006; Nunez et al., 2005; Yamaguchi,

2005) have allowed the analysis of very complex lipid mixtures. Supercomputers have enabled sophisticated molecular modeling. An energy minimization approach could be used to describe bilayer structures for mixed surfactants. A great deal has been learned about lipid crystal networks (for example, see Marangoni, 2004). Advances in the design of surfactants to form vesicles show promise for drug delivery and targeting (Ucheabu, 2000). Food scientists could search for structure/function relationships in model and real food products.

14.3.2 Advances in Measurement of Emulsions, Dispersions, and Foams

Recent developments in instrumentation have allowed scientists to measure bulk, surface and interfacial properties in many systems which contribute functionality in foods. Techniques for measurement of interfacial properties (McClements 2004a), emulsion rheology (Chakrabarti, 2006; McClements, 2004b), and microscopy (Groves, 2006) have been described in some detail. Of particular interest has been the effort to measure interfacial viscosity and elasticity, and to determine their effects on emulsion stability (Ivanov et al., 2005; Yarranton et al., 2007; Zerín and Narsinham, 2005). Since surfactants and surface-active proteins comprise the interfacial layer, surfactant systems may be designed to optimize interfacial properties. Techniques to measure interfacial rheology in intact emulsions throughout shelf life, would be very useful. Electron spin resonance (esr) line splitting, with an appropriate surface probe, might be a way to accomplish this.

14.3.3 Modulation of Flavor and Nutritional Molecules

Most flavor molecules are amphiphilic, having both polar and non-polar functional groups. Interactions of flavor systems with other food ingredients are well known (McClements, 2004c; Preininger, 2006). Food surfactants can be a two-edged sword with respect to flavor. As noted in Chap. 2, preparation at high temperatures generates by-products, which have disagreeable odors and flavors. Conversely, by modifying the partition coefficients between lipid, aqueous, and air phases, flavor release profiles can be modified. Enhancement of dairy flavor, through use of a surfactant coated fat, has been reported (Takada et al., 2004). The difficulty in developing this technology is a multi-dimensional labyrinthian complexity. As previously discussed, commercial food surfactants are mixtures of molecular structures. Flavors are also mixtures, and each component has a unique threshold and partition coefficient. Flavor release is expressed as a time-intensity plot. Sophisticated computer modeling should contribute to more practical use of surfactants for flavor modulation. Progress is most likely with simple surfactants and flavors. However, serendipity has been known to jump-start the systematic approach.

Mesomorphic phases contain lipophilic and hydrophilic pockets, which can protect sensitive ingredients from external environments. For this reason, they have been utilized to deliver pharmaceutical molecules to targeted organs and control their release (for example, see Hiller and Lloyd, 2002; Ghosh, 2005). Food surfactants have been used to improve bioavailability of some vitamins and minerals (Geraert et al., 2005; Lee et al., 2006). As the development of functional and performance foods and drinks continues, efficient delivery of nutrients should become more refined.

14.4 Design, Synthesis, and Commercial Preparation

Due to the extraordinary cost and time required to establish safety for government approval, new synthetic food surfactants are unlikely to be developed. However, scientists and engineers will need to solve a number of synthetic and processing challenges. High temperature processes raise energy costs and produce undesirable side reactions. To solve this problem, innovative methods, such as enzymatic reactors or phase-transfer catalysis, must be developed to optimize reactive contact between polar and lipid starting materials. Laboratory synthesis and purification will be necessary to understand the function of pure surfactant molecules in complex applications, such as bioavailability and flavor modulation. High energy costs have led to the development of biodiesel fuels, derived from fats and oils. Saturated fatty acids and their derivatives are unsuitable for winter fuel use. These by-products offer an opportunity for new starting materials for manufacture of surfactants (Ahmad et al., 2007). Scientists will be challenged to convert these starting materials into food-grade ingredients.

Natural surfactants, such as phospholipids and proteins, will continue to be important in food formulations. Production of biofuels is likely to distort costs for these ingredients. Increased production of soybeans for biodiesel will increase the available supply of lecithin. As corn is diverted from food to ethanol, dairy and grain proteins will become more expensive. Researchers will need to adjust formulations to minimize cost, while continuing to deliver acceptable sensory attributes. Interactive effects, discussed in Chaps. 4, 5, and 6, may be leveraged to extend the functionality of costly ingredients.

14.5 Applications at the Frontiers

Product developers will be navigating an environment of changing consumer needs and preferences, government regulations, cost pressures, and limited R&D budgets. Partnerships with government and academic researchers will probably provide a useful range of analytical, ingredient and processing technologies.

Each category will face its own set of challenges and opportunities. The dairy industry must deliver nutritional and functional benefits, while minimizing saturated

fats and sugar. Yogurts, for example, have recently claimed benefits promoting regularity and immune response. Indulgence foods, such as chocolate and ice cream, may also do this, but must retain their indulgent image. Specialty nutrition for infants, the elderly, and athletes will continue to evolve, and possibly invade mass marketing channels. Baking, as a substitute for frying, presents an opportunity to reduce fat absorption. However, the baked products must deliver the flavor and texture of the fried version. Many of these formulation issues involve surface or interfacial phenomena. Surfactants will undoubtedly be candidates to deliver solutions.

Acknowledgments The author is indebted to Julia Hasenhuettl for her assistance with library research and manuscript preparation.

References

- Ahmad, S. et al. (2007), "Beyond Biodiesel: Methyl Esters as the Route for the Production of Surfactants Feedstocks," *INFORM* 18(4): 216–20.
- Byrdwell, W. C. (2005), "Dual Parallel Liquid Chromatography/Mass Spectrometry for Lipid Analysis," in Byrdwell, W. C. (ed.), *Modern Methods for Lipid Analysis by Liquid Chromatography, Mass Spectrometry, and Related Techniques*, AOCS Press, pp. 510–577.
- Chakrabarti, S. (2006), "Probing Ingredient Functionalities in Food Systems Using Rheological Methods," in Gaonkar, A., McPherson, A. (eds.), *Ingredient Interactions: Effects on Food Quality*, Second Edition, CRC Press, pp. 49–86.
- Driskell, J. A. (2007), *Sports Nutrition: Fats and Proteins*, CRC Press.
- Federal Register (2004), 69(40): 9559–60. www.archives.gov/federalregister.
- Flack, E. (1992), Food Technology International-Europe, Sterling Publications, pp.79–81.
- Geraert, P. et al. (2005), "The Use in Animal Nutrition of Alimentary Emulsifiers Sorbitol Monolaurate and Monooleate in Association with a Derivative of Vitamin E, especially Tocopherol Acetate, to Improve Its Bioavailability," *Fr, Pat* 2861261, Apr. 20.
- Ghosh, T. K. (ed.) (2005), *Drug Delivery to the Oral Cavity: Molecules to Market*, Informa Healthcare Ltd.
- Groves, K. (2006), "Microscopy: A Tool to study Ingredient Interactions in Foods," in Gaonkar, A., McPherson, A. (eds.), *Ingredient Interactions: Effects on Food Quality*, Second Edition, CRC Press, pp. 21–48.
- Gunstone, F. (2006), *Modifying Lipids for Use in Food*, CRC Press.
- Han, Y, Gross, R. W. (2005), "Toward Total Cellular Lipidome Analysis by ESI Mass Spectrometry from a Crude Lipid Extract," in Byrdwell, W. C. (ed.), *Modern Methods for Lipid Analysis by Liquid Chromatography, Mass Spectrometry, and Related Techniques*, AOCS Press, pp. 489–509.
- Hegsted, D. M. et al. (1965), *Am. J. Clin. Nutr.* 17: 281–95.
- Hiller, A. M., Lloyd, A. W., (eds.) (2002), *Drug Delivery and Targeting*, CRC Press.
- Israelachvili, J. (1992), "Thermodynamic Principles of Self-Assembly," in Israelachvili, J. (ed.), *Intermolecular and Surface Forces*, Academic Press, pp. 341–94.
- Ivanov, I. et al. (2005), "Interfacial Rheology of adsorbed Layers with Surface Reaction: on the Origin of the Dialational Surface Viscosity," *Adv. Colloid Interface Sci.*, 114–15: 61–92.
- Judd, J. T. (2002), *Lipids* 27: 123–31.
- Kern, M. (2005), *CRC Desk Reference on Sports Nutrition*, CRC Press.
- Keys, A. et al. (1965), *Metabolism* 14: 717–87.
- Kodali, D. R., List, G. R. (2006), *Trans Fat Alternatives*, CRC Press.

- Larsen, A. et al. (2005), "Analysis of Phospholipids by Liquid Chromatography Coupled with On-Line Electrospray Ionization Mass Spectrometry and Tandem Mass Spectrometry," in Byrdwell, W. C. (ed.), *Modern Methods for Lipid Analysis by Liquid Chromatography, Mass Spectrometry, and Related Techniques*, AOCS Press., pp. 19–60.
- Lee, J. et al. (2006), "Method of Making Functional Drink, Having Enhanced Overall Palatability as well as Balanced Nutrition, Using Propolis Extract, Sugar, Emulsifiers, and Citric Acid," Kor. Pat. 2006024494A, Mar. 17, Assignee: Young Duk Gum.
- Marangoni, A. (2004), *Fat Crystal Networks*, CRC Press.
- McClements, D. J. (2004a), *Food Emulsions: Principles, Practices, and Techniques*, Second Edition, CRC Press, pp. 175–231.
- McClements, D. J. (2004b), *Food Emulsions: Principles, Practices, and Techniques*, Second Edition, CRC Press, pp. 341–387.
- McClements, D. J. (2004c), *Food Emulsions: Principles, Practices, and Techniques*, Second Edition, CRC Press, pp. 389–430.
- Mensink, R. P., Katan, M. B. (1990), *N. Engl. J. Med.* 323: 430–35.
- Morley, J. E., Thomas, D. R. (2007), *Geriatric Nutrition*, CRC Press.
- Mossoha, M. M. (2006), *Analysis and Lipidomics: New Techniques and Applications*, CRC Press.
- Nunez, A. et al. (2005), "Liquid Chromatography/Mass Spectrometry Analysis of Biosurfactant Glycolipids Secreted by Microorganisms," in Byrdwell, W. C. (ed.), *Modern Methods for Lipid Analysis by Liquid Chromatography, Mass Spectrometry, and Related Techniques*, AOCS Press, pp. 447–477.
- Preininger, M. (2006), "Interactions of Flavor Components in Foods," in Gaonkar, A., McPherson, A. (eds.), *Ingredient Interactions: Effect on Food Quality*, Second Edition, CRC Press, pp. 477–512.
- Singh, M. A. F. (2000), *Exercise, Nutrition, and the Older Woman: Wellness for Women Over Fifty*, CRC Press.
- Takada, Y., et al. (2004), "Food Emulsifiers Containing Glycerin Organic Fatty Acid Esters, Milk Component Gel Foods, Their Manufacture, and Enhancement of Dairy Flavor," Jap. Pat. JP 2004261063A, Sept. 24, Assignee: Saneigen F. F. I., Inc.
- Ucheabu, L. F. (2000), *Synthetic Surfactant Vesicles, Niosomes, and Other Non-phospholipid Vesicle Systems*, CRC Press.
- Warshaw, H. S., et al., (2004) *ADA Complete Guide to Carb Counting*, Second Edition, American Dietetic Association.
- Yamaguchi, R. (2005), "Analysis of Molecular Species of Plant Glycolipids by HPLC/APCI-MS," in Byrdwell, W. C. (ed.), *Modern Methods for Lipid Analysis by Liquid Chromatography, Mass Spectrometry, and Related Techniques*, AOCS Press., pp. 431–446.
- Yarranton, H. W. et al. (2007), "Effect of Interfacial Rheology on Model Emulsion Coalescence," *J. Colloid Interface Sci.*, 310(1): 253–259.
- Zerin, W. M., Narsinham, G. (2005), "Interfacial Dialational Elasticity and Viscosity of beta-Lactoglobulin at Air-water Interface Using Pulsating Bubble Tensiometry," *Langmuir*, 21(10): 4482–4489.

Index

A

- Acetic acid esters, as whipped topping emulsifiers, 208
- Acid value
 - determination of, 42–43
 - of direct esterification, 15
- Admul Wol, 343–344
- Adsorption, 89
 - associative, 190, 191–192
 - competitive, 117, 190–191
 - kinetics of, 379–382
 - layered, 190, 192
 - in milk proteins, 197–198
 - of protein-emulsifier complexes, 136–140
 - in thin films, 115–117
- Aeration, 8
 - of ice cream, 197
 - of industrial fillings, 321
- Aging, of ice cream, 197, 200, 201, 335
- Albumin, elution of, 129
- Alcoholysis, 264
- Alginic acid, 28
- Alkylether sulfates, interaction with proteins, 102–103
- Alkylsulfates, interaction with proteins, 102–103
- Alkyltrimethylammonium surfactants, effect on fibrinogen elution, 119–120
- Allergies, to milk protein, 234
- American Oil Chemists Society (AOCS), 39
- Amino acids, 11
- Amphoteric emulsifiers, structure of, 11, 12
- Amylase, interaction with emulsifiers, 302
- Amylopectin, 278
 - complexes of, 65, 69, 72
 - X-ray diffraction patterns of, 77
 - retrogradation of, 72–73
 - structure of, 64
- Amylose
 - binding with fatty acids, 75
 - complexes of, 64–65, 66, 68
 - as release agents, 80–81
 - interaction with flavor components, 64–65
 - structure of, 64, 65
 - infrared spectroscopy of, 77
 - X-ray diffraction patterns of, 77
- Amylose-complexing ability, of surfactants, 76
- Amylose-complexing agents, 66, 68, 302
- Amylose-complexing index (ACI), 302
- Analyses, of food emulsifiers, 39–62
 - analytical specifications and, 57–58
 - instrumental methods, 50–58
 - gas-liquid chromatography, 51–53
 - high-performance liquid chromatography, 41, 48, 53
 - high-performance liquid chromatography/mass spectrometry, 48, 54–55
 - mass spectrometry, 54
 - nuclear magnetic resonance, 56–57
 - spectroscopic methods, 55–56
 - of physical properties, 48–50
 - color, 48–49
 - melting point, 49–50
 - refractive index, 49
 - specific gravity, 50
 - viscosity, 50
 - sample extraction methods, 39
 - standardized test methods, 39
 - thin layer and column chromatography, 40–41
 - wet chemical analysis, 41–48
 - acid value/free fatty acid, 42–43
 - of fatty acids soaps, 47
 - hydroxyl value, 45
 - iodine value (IV), 43
 - lactic acid analysis, 46
 - moisture analysis, 46–47

- Analyses, of food emulsifiers (*cont.*)
 of α -monoacylglycerol, 41–42
 peroxide value (PV), 44
 of phosphorus and phospholipids, 47–48
 Reichert-Meisel value, 46
 saponification value, 44–45
- Animal fats, as bakery shortening, 263–264
- Anionic emulsifiers, 275
 for bakery products, 269, 272, 344
 protein interactions of, in solutions, 102–105
 structure of, 11, 12
- Anti-bloom agents, for chocolate and
 compound coatings, 295–296
- Antioxidants, as food additives, 327
 in margarine and spreads, 325
- Anti-spitting agents, 223
- Apolipoprotein A-I, 124
- Aqueous solutions, protein/emulsifier
 interactions in, 97–107
- Arabic gum, 82
- Ascorbyl palmate, 325
- Ash, as wheat flour component, 266
- Association of Official Analytical Chemists
 (AOAC), 39
- Athletes, nutritional products for, 398
- Atmospheric pressure chemical ionization
 (APCI), 54–55
- B**
- Bakery emulsifiers, 263–284
 anionic, 269, 272, 344
 applications in baked goods, 269, 272,
 276–283, 344
 in chemically-leavened products,
 279–281
 in cream icings, 281
 crumb softening, 278–279
 dough conditioning, 276–277
 in extruded snacks/cereals, 281
 in fat-free bakery products, 281–282
 as release agents, 282
 as trans fat-free shortening, 282–283
 in yeast-raised products, 276–279
 definition of, 263, 264
 functions of, 264, 265–267
 history of, 263–264
 interaction with bakery components, 272,
 274–276
 market value of, 267
 polyhydric, 270–271, 273
 role of, 268–272
 in shortenings, 264, 265
 sorbitan, 269, 270, 271
- Bakery products
 fat-free, 281–282
 method of preparation of, 350
 rheological measurements in, 81
 stabilization of, 350
- Bancroft Rule, 5, 185–186
- Barley starch, effect of emulsifiers or
 complexing agents on, 68, 69
- Batch esterification/interesterification reactors,
 30–31
- Beef tallow, as margarine component, 1,
 314, 341
- Beverage emulsifiers, 389
- Biofuels, 400
- Bio-polymer gels, 345
- Bioreactors, for esterification and
 interesterification, 32–34
- Biosensors, amperometric and potentiometric,
 154
- Bleaching, of surfactants, 44
- Bovine milk. *See* Milk
- Bovine serum albumin, 224, 247
 interaction with
 lecithin-cardiolipin mixed bilayers, 111
 Triton X surfactants, 105
- Bread dough, frozen, 81
- Bread making, 275
 crumb softening in, 278
- Breast milk, whey protein:casein ratio in, 223
- Bubble gum, emulsifiers for, 285, 299
- “Bubble-time” method, of viscosity
 measurement, 50
- Butter
 consumption rates, 308
 hard, nuclear magnetic resonance analysis
 of, 56
 method of preparation of, 350
 stabilization of, 350
 as water-in-oil emulsion, 349, 350
- Butterfat, interactive forces in, 64
- Buttermilk powders, 206
- C**
- Cake
 emulsifiers for, 279
 fat-free/low-fat, 282
 fillings for, 321
 microwavable, 81
- Cake batter
 rheological measurements in, 81
 whipping of, 344
- Calcium caseinate, 248
- Calcium salts, of fatty acids, 47

- Calcium stearyl lactylate
 - as bakery emulsifier, 265, 272, 277, 278, 344
 - as crumb softeners, 279
- Caloric balance, 396–397
- Calorimetry, differential scanning, 79–80
 - of β -lactoglobulin/distearoylphosphatidic acid interactions, 110
- Candy
 - chewy, 303
 - emulsifiers for, 285, 299, 300, 301
 - starch-based, 301–303
- Canola oil, as cheese ingredient, 217–218
- Capillary melting point, 49–50
- Caramel
 - emulsifiers for, 299, 300–301
 - fat content of, 301
 - ingredients, 300
- Carbohydrate(s), in infant nutritional products, 235
- Carbohydrate-emulsifier interactions, 63–88, 397–398
 - effects of external lipids on, 65–74
 - enzymolysis of starch, 68, 73–74
 - iodine binding capacity, 66, 69, 70
 - starch gelatinization, 66, 67, 68, 71–72
 - starch pasting, 66, 67, 69, 70–71
 - starch retrogradation, 68, 69, 72–73
 - lipid adjunct and emulsifier properties in, 74–76
 - effect of environmental conditions on, 75–76
 - starch granules, 74–75
 - starch types and source, 75
 - of simple saccharides, 63–64
 - in starch/emulsifier complexes, 64–65
- Carbon (^{13}C), chemical shifts of, 57
- Carrageenan, in infant nutritional products, 245, 250
- Casein(s), 11, 323, 391
 - as dairy protein-based emulsifiers, 222
 - emulsifying characteristics of, 247
 - heat stability of, 222
 - micellar, 248
 - non-micellar, 248
 - as whipping cream component, 205–206
- α_1 -Casein, structure and molecular weight of, 391
- β -Casein
 - binding with sucrose esters, 105
 - emulsifying characteristics of, 247
 - interaction with Tween 20, 125–126
 - structure and molecular weight of, 391
- Casein hydrolysates, in infant nutritional products, 246, 250
- Casein micelles, 195
- Casson parameters, 287, 289
- Castor oil, composition of, 313
- Cationic emulsifiers
 - interaction with proteins
 - at hydrophilic surfaces, 119
 - in solutions, 107
 - structure of, 11, 12
- Cavitation flow, 366
- Cavitation threshold, 366
- Cellulose, 82
 - alkyl esters of, 29
- Cereals, extruded, 281
- Cetyl-trimethyl ammonium bromide, 216–217
 - effect on milk protein heat stability, 221–222
- Cheese, 215, 217–219
- Cheese products, processed, 215–217
- Chewing characteristics, of confections, 299
- Chewing gum, 285, 299, 300
- Chloroform, use in emulsifier extraction, 39, 40
- Chocolate
 - emulsifiers for
 - as anti-bloom agents, 295–298
 - functions of, 285
 - lecithin, 286, 288–291
 - polyglycerol polyricinoleate, 286, 293–295
 - synthetic lecithin, 291–293
 - fat bloom on, 295–298
 - causes of, 295, 296
 - control of, 297–298
 - fat content of, effect of lecithin on, 289
 - rheological properties of, 287
 - tempering of, 296
 - uncontrolled crystallization of, 296
 - viscosity of, 7, 286, 287, 289
 - effect of lecithin on, 289–290
 - yield value of, 287, 289, 290
- Chocolate bars
 - fat bloom on, 296
 - molding process for, 293–294
- Chocolate-enrobing tunnels, release agents for, 304
- Cholesterol, 397
 - as mayonnaise emulsifier, 387, 389
- Choline ethanolamine inositol serine, 274
- Chromatography, 398–399
 - column, 40–41
 - gas-liquid, 51–53
 - high-performance liquid, 41, 48, 54
 - in combination with mass spectroscopy, 48
 - for peroxide value determination, 44
 - inverse gas, 64
 - thin layer, 40–41, 48

- Citric acid esters
 of diglycerides
 as infant nutritional product emulsifiers, 239, 240
 as margaine emulsifiers, 318, 321
 of monoglycerides (CITREM)
 hydrophilic-lipophilic balance value of, 254
 as infant nutritional product emulsifiers, 239, 240, 245, 254
 as ionic oil-in-water emulsifier, 241
 production/formation of, 241
- Citric acids, as reduced-fat/low-fat spread emulsifiers, 322
- Clathrates, 64, 77
- Coalescence, 89, 99, 354, 367–378
 collision of two drops in, 369–372
 definition of, 354
 electrostatic force of interaction in, 375–376
 energy dissipation rate in, 376, 377
 of fat globules, in whipped cream, 329
 Fokker Planck equation for, 373
 in high-pressure homogenizers, 368–369, 370, 376, 378
 in ice cream, 201
 partial, 338–339
 prevention of, 337–338
 in margarine, 343
 models of efficiency of, 372–378
 net turbulent force in, 374
 oil-water interface stability and, 382–383
 rate of, 372, 373, 374
 stochastic nature of, 372–373
 surfactant-based prevention of, 379
 time distribution of, 376, 377
 van der Waals' forces in, 367, 375
 in whipped cream, 332, 375
- Coatings. *See also* Compound coatings
 confectionery
 viscosity of, 64
 water vapor permeability through, 64
 emulsifier functions in, 285
- Cocoa butter
 Casson plastic viscosity of, 294–295
 crystallization of, 296
 crystallization rate of, 297
 effect of surfactants on, 287
 as fat source in chocolate, 286
 interactive forces in, 64
 polymorphic forms of, 296
 reduction in, 295
 as release agent, 304
 viscosity of, 290, 291
 effect of lecithin on, 293
 yield values of, 294
- Coconut oil, 313, 318
- Codex Alimentarius, 241
- Coffee creamers and whiteners, 213–215
- Colloid mills, 356, 360, 362
- Color determination, of emulsions, 48–49
- Compound coatings
 composition of, 286–287
 emulsifiers for
 as anti-bloom agents, 295–298
 lecithin, 286, 288–291, 289
 polyglycerol polyricinoleate, 286, 293–295
 synthetic lecithin, 291–293
 fluidity of, 287
 lauric, 299
 viscosity of, 286, 287
- Confectionery emulsifiers, 285–305. *See also*
 Bakery emulsifiers
 anti-bloom agents, 295–298, 304
 in chocolate and compound coatings, 286–295
 lecithin, 288–291
 polyglycerol polyricinoleate (PGPR), 293–295
 synthetic lecithin, 291–293
 functions of, 285
 in non-chocolate confectionery, 299
 as plasticize and hydration agents, 300, 304
 as processing aids, 303–304
 as release agents, 303–304, 304
 roles of, 304
 for viscosity control, 285, 287, 289–294, 304
- Confections, viscosity of, 64
- Confocal laser scanning microscopy, 81
- Consumer acceptance, of emulsifier-containing food products, 58
- Continuous interestification reactors, 31–32
- Cookies, 280–281
- Copper ions, as oxidative risk factor, 324
- Corn. *See also* Maize starch
 as ethanol source, 400
- Corn oil
 as lecithin source, 271
 oxidation of, 324
- Coronary artery disease, 397
- Cottonseed oil, 263–264
 composition of, 313
 oxidation of, 324
- Crackers, 280–281
- Cream. *See* Whipping cream
- Creaming, 89
 in beverages, 389
 in cream liqueurs, 211, 212–213
 in infant nutritional products, 237, 243, 244, 248, 250

Cream liqueurs, 210–213
 Cream margarines, emulsifiers for, 318–319
 Crumb softeners/softening, 278–280
 Crystallization
 of chocolate, 294
 of cocoa butter, 296, 297
 effect of surface activity on, 173
 of starch/surfactant complexes, 79, 80
 Cubic phases
 applications of, 152, 154
 lipase-induced decomposition of, 149–150
 lipid-based liquid-crystalline, 150–156
 in lipolysis, 150
 monolein-aqueous, 150–152, 153, 154
 Cubosome® particles, 97, 154
 Cubosomes, 341
 protein-loaded, 155–156
 Cytochrome c, 113, 120–123, 152

D

Dairy products. *See also* Butter; Ice cream; Milk; Yoghurt; Whipped cream; Whipping cream
 additives to, 196
 emulsifiers for, 195–232
 Dairy protein-based emulsions, 222–223
 DATEM. *See* Diacetyl-tartaric acid ester of monoglyceride (DATEM)
 De-oiling, of lecithin, 240
 Destabilization, of emulsion products, 349
 Diabetes mellitus, 397–398
 Diacetyl-tartaric acid ester of monoglyceride, 269, 270
 acid value of, 42
 amylose-complexing index value of, 302
 as chocolate and compound coating emulsifier, 299
 as crumb softener, 279
 effect on gelatinization of starch, 274
 effect on starch pasting characteristics, 302
 in fat-free bakery products, 282
 hydrophilic-lipophilic balance value of, 254
 as infant nutritional product emulsifier, 240, 245, 254
 as ionic oil-in-water emulsifier, 241
 production/formation of, 241
 synthesis of, 24
 Diacylglycerols. *See* Diglycerides
 Diacylglycerols, gas-liquid chromatographic analysis of, 51
 Differential scanning calorimetry, 79–80
 of β -lactoglobulin/distearoylphosphatidic acid interactions, 110

Diglycerides
 amylose-complexing index value of, 302
 citric acid esters of
 as infant nutritional product emulsifiers, 239, 240
 as margarine emulsifiers, 318
 composition of, 240
 as crumb softeners, 278–279
 as emulsifiers
 in caramel, 301
 in chocolate and compound coatings, 298
 in fat-free bakery products, 282
 in fudge, 301
 in ice cream, 203
 in infant nutritional products, 239, 240, 246, 251, 253–256
 in margarine, 318, 319, 321
 in processed cheese, 216
 in toffee, 301
 ethoxylated, commercial preparation of, 26
 hydrophilic-lipophile balance values of, 240
 as palm oil component, 314
 structure of, 5
 synthesis and commercial preparation of, 14–16, 240
 Diglycerols, separation of, 40
 Dioleoylglycerol, 112–113
 Dioleoylphosphatidylcholine, 112, 113
 Dioleoylphosphatidylethanolamine, 114
 Dipalmitoylphosphatidic acid, interaction with β -lactoglobulin, 121, 123
 Direct Food Additives, 3, 389–390
 Distearoylphosphatidic acid, interaction with β -lactoglobulin, 110–111
 Donuts, 280
 Dough conditioning, 276–277
 Doughnuts, 280
 “Dough strengthener,” 269, 275
 Dough strengthening, 7, 8
 Droplet/droplet interactions, 89
 Droplet phenomena, 354–387. *See also*
 Coalescence
 cavitational flow, 366
 drop breakage (disruption), 354, 355–367
 Bernouilli’s equation in, 364
 breakage rate, 364–366
 deformation parameters, 358–359
 as dispersal phase viscosity cause, 363, 364
 drop deformation parameters, 359–360
 extensional flow, 360, 362
 external flow, 356–358, 357–359
 hyperbolic flow, 356, 357, 360, 361, 362
 interfacial stress, 355
 laminar flow, 356–360, 367

- Droplet phenomena (*cont.*)
 Laplace pressure, 355
 rate of, 364–366
 Reynolds numbers for, 356, 357, 360, 362
 shear flow, 356–357, 357–359, 358, 359
 shear rate, 360
 shear stress, 354, 355–367
 steady-state shear flow, 359
 turbulent flow, 360–364, 365
 viscosity ratios, 356–357, 360, 361
 Weber numbers for, 360, 361–362, 365–366
 role of surfactants and proteins on emulsion formation, 379–387
 adsorption kinetics of, 379–382
 interfacial rheology of, 381–382
 mechanisms of stabilization in, 382–387
 shear rheology of, 381–382
 turbulent flow, 360–364
 in whipped cream, 329–330
- Droplet size
 in homogenized dairy whipped cream, 331
 in non-dairy whipped cream, 331
- Dropping point, 49–50
- Drug delivery systems, 154–155
- E**
- Egg yolks
 as emulsifiers, 11
 as mayonnaise component, 387, 388, 389
 phospholipid analysis of, 52, 54
 as salad dressing stabilizer, 389
- Elasticity, measurement of, 399
- Elderly individuals, nutritional products for, 398
- Electron spin resonance, 77–78
- Electron spin resonance line splitting, 399
- Electrospray ionization, 54–55
- Electrostatic double layer forces, 89
- Electrostatic forces, in protein/emulsifier interactions, 120–122
- Emulfluid A, 185
- Emulfluid E, 185
- Emulsifier(s). *See also* Bakery emulsifiers; Confectionery emulsifiers; *names of specific emulsifiers*
 adsorption kinetics of, 379–382
 annual worldwide production and sales of, 2
 blends of, 8
 as cheese ingredient, 217–218
 for candy, 303
 classification of, 185–190, 389–391
 Generally Recognized as Safe (GRAS), 3, 389, 390
 hydrophilic-lipophilic balance (HLB) concept of, 187–188
 phase inversion concept of, 186–187
 Regulated Direct Additives, 3, 389–390
 solubility concept of, 185–186
 concentration required for emulsification, 191
 duplex, 344
 forecasting trends in, 395–402
 advances in science and technology, 398–400
 design, synthesis, and commercial preparation, 400
 globalization, 395–396
 nutritionally-driven changes in food, 396–398
 functions of, 349
 government regulations for, 389–390
 history of, 1
 naturally-occurring, 11, 400
 oil-water interface stabilizing effects of, 382–387
 interfacial rheology of, 382, 385, 386–387
 interfacial viscoelasticity of, 385–386, 388
 Marangoni effect, 382, 383–385
 shear rheology of, 385, 386
 overview of, 1–9
 selection of, 8
 guidelines for, 389–391
 small molecule, protein-displacing activity of, 8
 structure of, 4–6
 suppliers of, 8
 as surfactants, 4
 synthetic
 history of, 1
 obstacles to development of, 4, 400
 water/oil interface orientation of, 2
- Emulsifying agents, definition of, 264
- Emulsion(s)
 definition of, 349
 examples of, 349, 350
 interfacial tension of, 349
 oil-in-water, 349
 thermodynamic instability of, 89, 349
 water-in-oil, 349
- Emulsion-based food products, examples of, 387–389
- Emulsion formation, 349–394
 droplet phenomena in. *See* Droplet phenomena
 energy requirements for, 355

- equipment for. *See* Equipment, emulsification
- role of emulsifiers and proteins in, 189–190, 379–387
 - adsorption kinetics of, 379–382
 - interfacial rheology of, 379–380, 381–382
 - mechanisms of stabilization in, 381–387
 - shear rheology of, 381–382
- Emulsion gels, in cheese, 217–219
- Enteral milk products, 219
- Enzymes. *See also names of specific enzymes*
 - lipolytic, 149–140
- Equipment, emulsification, 350–354
 - colloid mills, 350–351, 356, 360
 - high-speed blenders, 351–352
 - homogenizers
 - high-pressure, 352–353, 360–364, 368–369, 370, 376, 378
 - high-speed, 351–352
 - membrane, 354
 - ultrasonic, 353–354
 - liquid jet generators, 353–354
 - piezoelectric transducers, 353–354
 - pitting of, 366
 - piezoelectric transducers, 353
 - shear rate variability of, 367
 - for synthesis and commercial preparation
 - of emulsifiers, 30–34
 - batch esterification/interestification reactors, 30–31
 - bioreactors for esterification and interestification, 32–34
 - continuous interestification reactors, 31–32
 - ethoxylation/propoxylatic reactors, 34
- Esterification, 264
 - of alginate, 28, 29
 - direct
 - of monoglycerides and diglycerides, 14–15
 - of propylene glycol esters, 16, 17
 - of propylene glycol monoesters, 17, 18
 - enzyme-catalyzed, of monoglycerides and diglycerides, 15–16
- Esterification/interestification reactors, 30–31
- Ethers, 82
- Ethoxylated diacylglycerols, synthesis of, 26
- Ethoxylated emulsifiers
 - protein adsorption-reducing effect of, 192
 - temperature-dependent hydrophilicity of, 186–187
- Ethoxylated monoglycerides, 277, 278
- Ethoxylated monoglycerol, synthesis of, 26
- Ethoxylation/propoxylatic reactors, 34
- Ethylene oxide (oxirane), 25–26
- European Economic Community regulations
 - for bakery emulsifiers, 266
 - for food emulsifiers, 3, 4
 - for infant nutritional products, 239–240
- Evaporated milk, 221–222
- F**
- FAC method, of color determination, 48–49
- Fast atom bombardment (FAB), 54
- Fat
 - in bakery products, 263
 - caloric content of, 397
 - in candy, 303
 - in chocolate, 286
 - in compound coatings, 286
 - in ice cream, 335
 - in industrial fillings, 321
 - in infant nutritional products, 235
 - in margarine, 307, 309, 319
 - physical properties of, 310–312
 - plastic, 315
 - in reduced-fat and low-fat spreads, 321, 322
 - saturated, 308
 - baking functionality of, 344
 - as coronary artery disease cause, 397
 - in spreadable products, 307, 309–310. *See also* Butter; Margarine; Spreads
- Fat bloom, in chocolate and compound coatings, 295–298
- Fat crystallization
 - in margarine and spreads, 312, 314–317
 - in reduced-fat and low-fat spreads, 322–323
- Fat crystals
 - in shortenings, 267–268
 - structure of, 312, 314–315, 316
- Fat-free foods, 397
 - starch networks in, 70
- Fat mimetics, 397
 - in zero-fat ice cream, 339
- Fat-reduced food products, 397
 - cake margarine, 319
 - consumer demand for, 327
 - homogenized dairy whipping cream, 328–330, 331–332
 - ice cream, 333–341
 - non-dairy whipping cream, 328, 330–331, 332
 - spreads, 309–310, 321–323, 343–345
 - starch networks in, 70
- Fatty acid chains, short spacing between, 314, 316

- Fatty acids
 acid value of, 42–43
 composition of, 313
 gas-liquid chromatographic analysis of, 51–52
 long-chain polyunsaturated, 310
 as margarine component, 310–312
 melting points of, 312, 314
 oxidation of, 324–325
 propylene glycol esters of, synthesis and preparation of, 16–17
 saponification value of, 44–45
 saturated, 4–5
 as source of off-flavors, 12–13
 structure of, 12
 sucrose esters of, 273
 as bakery emulsifiers, 270–271, 273
 characteristics of, 241
 chromatographic analysis of, 41
 as confectionery emulsifiers, 285–286
 as crumb softeners, 279
 effect on starch gelatinization temperature, 79
 high-pressure liquid chromatographic analysis of, 53
 as ice cream emulsifiers, 202
 as infant nutritional product emulsifiers, 254
 in infant nutritional products, 239, 240
 interaction with starches, 75, 76
 mass spectrometric analysis of, 54
 novel applications of, 224
 spectroscopic analysis of, 56
 synthesis of, 19–21, 241
 unsaturated, 4–5
 iodine value of, 43
 structure of, 13
- Fatty acid soaps, 47
- Fiber, as wheat flour component, 266
- Fibrinogen, elution of, 119–120, 129
- Fillings, industrial, 321
- Flavor molecules, modulation of, 399
- Flocculation, 89
- Florisol, 65, 291
- Flour
 interaction with emulsifiers, 272
 lipid content of
 interaction with emulsifiers, 275–276
 nonpolar form of, 275
 polar form of, 275
 wheat
 composition of, 265, 266
 interactions with emulsifiers or complexing agents on, 66, 67, 266
 processing of, 265
 protein/emulsifier interactions in, 275
- Foam
 in ice cream, 198–199
 in β -lactoglobulin, 124
 protein-emulsifier interactions in, 136–141
 stabilization/destabilization mechanisms in, 115, 116
 in whipped cream, 8, 328–329
 in whipped toppings, 208, 210
- Food additives
 emulsifiers as, 2–4
 government regulations regarding, 39
 nutritional, 327
- Food and Drug Administration (FDA)
 ice cream classification system, 333, 334
 regulations of
 Direct Food Additives, 3, 389–390
 Generally Recognized as Safe (GRAS), 3, 389, 390
 for trans fatty acids, 397
- Food Chemical Codex, 267
- Fourier transform infrared spectroscopy, 56
- Freezers, for ice cream, 335
- Fructose, 63
- Frying
 fat emulsifier spattering during, 344
 use of reduced-fat spreads in, 322
- Frying oils, shortening as, 263
- Fudge
 emulsifiers for, 299, 300, 301
 fat content of, 301
 ingredients, 300
- Functionality, of emulsifiers, 7–8, 396
 multiple functionality, 8
- G**
- Gardner method, of color determination, 48
- Gastroesophageal reflux, in infants, 234
- Gelatinization
 effect of lecithin on, 218
 effect of whey protein concentrate on, 218
 of starch, 66, 67, 68, 71–72, 274
 differential scanning calorimetry of, 79–80
- Gels
 emulsion, in cheese, 217–219
 surfactant, water as component of, 46–47
- Generally Recognized as Safe (GRAS), 3, 389, 390
- Gibbs effect, 115, 116
- Gliadin, 275
- Globalization, of the food industry, 395–396
- Glucoamylase, 73–74

- Glucose oxidase, 154
- Gluten, 275
- Gluten-gluten binding, 277
- Glutenin, 275
- Glycemic index, 397
- Glycerine, high pressure liquid chromatographic analysis of, 53
- Glycerol
- esterification of, 14–15, 16
 - as humectant, 64
 - polymerization of, 17–18
 - structure of, 311
- Glycerol lactopalmitate, 209
- Glycerol monoglycerides, as confectionery emulsifier, 285–286
- Glycerol monooleate/glycerol monoleate
- amylose-complexing index value of, 302
 - in emulsion gels, 219
 - as ice cream emulsifier, 199, 202, 203
 - as whipped topping emulsifier, 208
- Glycerol monoolein, as infant nutritional product emulsifier, 253
- Glycerol monopalmitate
- as ice cream emulsifier, 337
 - as infant nutritional product emulsifier, 253
- Glycerol monostearate, 269, 270, 283
- amylose-complexing index value of, 302
- effect on starch gelatinization, 71, 80, 274
 - effect on starch pasting characteristics, 302
 - as emulsifier
 - in chocolate and compound coatings, 298
 - in coffee whiteners, 214
 - in cream liqueurs, 210, 211, 212–213, 224
 - in gums, 300
 - in ice cream, 199, 200–201
 - in infant nutritional products, 253–254
 - in processed cheese, 216–217
 - in starch-based candy, 302
 - in whipped topping, 208–209
 - in whipping cream, 206
- Glycidol, 15
- Glycol, polyoxyethylene derivatives of, 203
- Glycol esters, as ice cream emulsifiers, 202
- Glycolipid biosurfactant, high pressure liquid chromatography/mass spectrometry analysis of, 55
- Good manufacturing practice (GMP), for margarine and spreads, 324
- Groundnut oil
- composition of, 313
 - oxidation of, 324
- Guar, 82
- Gums
- as “all natural” emulsifiers, 4
 - arabic, 82
 - chewing, 285, 299, 300
 - composition of, 300
 - emulsifiers in, 300, 304
 - as infant nutritional product stabilizer, 241, 242
 - surface-active proteins of, 7
- H**
- Heavy metals contaminants, spectroscopic detection of, 56
- High-density lipoprotein, 124
- Homogenization
- of coffee whiteners, 213–214
 - of cream liqueurs, 210–211
 - definition of, 352
 - of ice cream, 196–197, 335
 - of infant nutritional products, 236–237, 243
 - of milk, 221
 - role of emulsifiers in, 189–190
- Homogenizers
- high-pressure, 352–353, 360–364, 365
 - drop coalescence in, 368–369, 370, 376, 378
 - turbulent flow in, 360–364, 365
 - turbulent kinetic energy in, 363–364
 - high speed, 351–353
 - membrane, 354
 - ultrasonic, 353–354
- Human milk, whey protein:casein ratio in, 223
- Human milk fortifier (HMF), 234
- Humectants, sugars as, 63–64
- Hydration, 89
- Hydrocolloids. *See also* Gums; Starch
- applications of, 81
 - in infant nutritional products, 234, 241, 242
 - interactions with surfactants, 81–82
 - in margarine and spreads, 319, 321, 322, 323, 325
 - surface-active, 7
- Hydrogenation
- partial, 282–283
 - selective, 311
 - of vegetable shortenings, 263–264
- Hydrogen bonding, effect on protein stability, 91
- Hydroperoxide, 44
- Hydrophile-lipophile balance (HLB) values, 5, 390–391
- definition of, 390
 - high, 5
 - low, 5
- Hydrophilic forces, 89
- Hydrophilicity, of ethoxylated emulsifiers, 186–187

- Hydrophilic-lipophilic balance (HLB) values,
 177, 187–188
 calculation of, 187
 comparison with geometry of molecules,
 188
 of confectionery emulsifiers, 286
 definition of, 187, 286
 limitations of, 188
- Hydrophilic-lipophilic values
 correlation with hydroxyl value, 45
 of lecithin, 240
- Hydrophobic interactions
 effect on protein stability, 91, 92
 in protein/emulsifier interactions, 123
- Hydroxyl groups, 13
- Hydroxyl value, 17
- Hyperbolic flow, droplet breakage in, 356, 357
- Hypoallergenic infant nutritional products,
 234, 255
- I**
- Ice cream, 196–204
 coalescence in, 201
 partial, 338–339
 prevention of, 337–338
 as complex oil-in-water emulsion, 349, 350
 composition of, 196, 197
 cryo scanning electron micrograph of,
 198–199
 definition of, 333
 economy, 333, 334
 emulsifiers for, 202, 203, 224, 334–339
 air-water interface adherence of,
 336–338
 crystalline phase behavior of, 201
 effect on fat, 200–204
 effect on fat globule adsorption, 198–199
 as shear-induced destabilization cause,
 199
 temperature-dependence of, 200–201
 fat content of, 333, 335
 effect on perceived creaminess, 333–334
 foam and air bubbles in, 198–199
 foam stabilization in, 198–199
 Food and Drug Administration
 classification of, 333, 334
 history of, 196
 light, 333
 low-fat, 333–339
 phase volumes of, 335
 manufacturing process, 196–197, 350
 aeration and freezing, 197, 335
 aging, 197, 200, 201, 335
 homogenization, 196–197
 pasteurization, 197, 335
 without emulsifiers, 197
 manufacturing process ag
 agng stage, 335
 microstructure of, 335–336, 339
 non-fat, 333
 premium, 333, 334
 phase volumes of, 335
 protein/fat globule adsorption in, 198–199,
 201
 regular, 333, 334
 ingredients, 335
 phase volumes, 335
 stabilization of, 350
 storage temperature, 335
 super premium, 333, 334
 zero-fat, 337, 338, 339–341
 fat mimetics in, 339
- Ice cream coatings, effect of polyglycerol
 polyricinoleate on, 295
- Ice cream freezers, 335
- Icings. *See also* Coatings
 cream, 281
- Immunoglobulin A, secretory, 238
- Indulgence foods, 401
- Infant nutritional products, 398
 casein-dominant, 235, 237, 245
 creaming in, 237, 242, 243, 244, 248, 250
 dehydration of, 237
 dry blended, 236, 237
 emulsifiers for, 233–261, 238–239,
 238–241
 formation and stabilization of, 235–
 238, 251–253
 functionality of, 241–255
 hydrolyzed milk proteins, 250
 non-hydrolysed milk proteins, 247–249
 non-protein, 239–241, 244, 245–246,
 247, 251–255
 protein-based, 238–239, 244, 245–246,
 247–249
 soy proteins, 234, 235, 239, 251
 stability of, 241–243
 stabilizers for, 245–246
 fat flecks, ringing, or phase separation in,
 237, 242, 243
 fat globule aggregation in, 237
 fat globule size distribution in, 236, 237
 free amino acids-based, 245, 246
 homogenization of, 236–237, 243
 hypoallergenic, 234, 255
 inactivation of microorganisms in, 237
 interfacial membrane formation in, 243, 244

- lactose-free, 234, 238–239
 - liquid, 236, 237
 - shelf life, 241–242
 - for low-birth-weight infants, 234, 235
 - as medical foods, 245–246
 - microfluidization of, 236–237
 - milk protein hydrolyzation in, 223
 - oiling off in, 242, 243
 - oil-in-water emulsion in, 233, 235, 237
 - powdered, 235–236, 243, 245–246
 - shelf life, 241–242
 - regulations regarding, 235, 239–240, 241, 242
 - shelf life, 241–242, 253
 - spray drying of, 237
 - stabilizers for, 241, 245–246, 251–253, 255
 - sterilization of, 223, 237–238
 - types of, 233–235
 - first-age, 234, 235, 241, 242, 245, 246
 - “follow-on,” 234–235, 242
 - ultra-high-temperature (UHT) treatment of, 237
 - van der Waals’ forces in, 251, 252
 - whey protein:casein ratio in, 233–234, 249
 - whey protein-dominant, 235, 245, 246
- Infrared spectroscopy, 55–56, 77
- INP. *See* Infant nutritional products
- Interesterification (glycerolysis), 264
- of monoglycerides and diglycerides, 14, 15, 16
 - of propylene glycol esters, 16, 17
 - of propylene glycol monoesters, 17, 18
 - of sucrose esters, 19–20
- Interfacial processes, in protein/emulsifier interactions, 156–157
- effect of protein film structure on, 124–126
 - effect of surface properties on, 126–144
 - of emulsifiers with low solubility, 141–144
 - of lipids with low aqueous solubility, 120–124
 - liquid-liquid interfaces, 129–141
 - solid-liquid interfaces, 126–129
- Interfacial rheology, in emulsion formation, 381–382
- Iodine binding capacity, 66, 69, 70
- Iodine value (IV), 43
- Ionic emulsifiers
- interactions with proteins, 97
 - at high surfactant concentrations, 125
 - in solutions, 105–106
- Ionization methods, 54
- in combination with microbore columns, 54–55
- Isoelectric point, of proteins, 11
- Isomerization, 264
- Isosorbide, chromatographic analysis of, 52
- ## J
- Jelly candies
- emulsifiers in, 299
 - starch-based, 301
- ## K
- Kosher-certified food emulsifiers, 4
- Krafft temperature, 119, 174
- ## L
- α -Lactalbumin
- in human milk, 238
 - as infant formula component, 234, 238, 239, 249
 - molten globule state of, 92, 93
- Lactating women, nutritional preparations for, 235
- Lactic acid, 20, 23
- analysis of, 46
 - as emulsifier, 269
 - use in surfactant manufacture, 46
 - water-soluble, 23
- Lactic acid derivatives, of monoglycerides
- as confectionery emulsifiers, 285–286
- Lactic acid esters, as whipped topping emulsifiers, 208
- Lactoferrin, n human milk, 238
- α -Lactoglobulin, emulsifying characteristics of, 247
- β -Lactoglobulin
- in bovine milk, 238
 - emulsifying characteristics of, 247
 - foamability and foam stability of, 124
 - heat-related denaturation of, 391
 - interactions of, 99–100
 - dipalmitoylphosphatidic acid, 121, 123
 - dissociation constants in, 99
 - distearoylphosphatidic acid, 110–111, 120–122
 - effects of surface properties on, 127–128, 129
 - egg yoke phosphatidic acid, 122
 - electrostatic forces in, 120–122
 - with lysozyme, 129
 - negatively-charged lipid monolayers, 122
 - nonspecific cooperative interactions, 102, 103
 - sodium dodecylsulfate, 103, 106–107, 118

- β -Lactoglobulin (*cont.*)
 Tween 20, 90, 125–126
 as milk protein emulsifier, 220
 molecular weight of, 391
 pH-dependency of, 391
 stabilized film thickness of, 386, 388
 structure of, 391
- Lactose, 63
 in ice cream, 335
- Lactose-free infant nutritional products, 234, 238–239
- Lamellar phase, aqueous layer of, protein penetration of, 111
- Laminar flow, droplet breakage in, 356–360, 367
- Lamination, of puff pastry dough, 320
- Laplace pressure, in droplet breakage, 355
- Lard, 263
- Lauric acid, 4
- Lauric fats
 interactive forces in, 64
 as non-dairy whipping cream component, 330
- Lauric oils, as cake margarine emulsifier, 318–319
- Lead, spectroscopic detection of, 56
- Leatherhead Foods Research Association, 39
- Lecithins
 as “all natural” emulsifier, 4
 amphoteric, 5
 amylose-complexing index value of, 302
 animal sources of, 27
 as bakery emulsifiers, 271–272, 274
 as caramel emulsifier, 301
 cationic, 5
 as chewing gum emulsifier, 300
 composition of, 288
 as confectionery emulsifier, 64, 285–286
 in chocolate and compound coatings, 285, 288–291, 294, 298
 in combination with polyglycerol polyricinoleate, 294–295
 comparison with polyglycerol polyricinoleate, 294
 in nougats and chewy candies, 303
 as cookies and cracker emulsifier, 280–281
 de-oiling of, 240
 effect on compound coating viscosity, 287
 effect on gelation, 218
 effect on milk heat stability, 222
 egg-based
 commercial preparation of, 27
 as infant nutritional product emulsifier, 240
 modification of, 12
 structure of, 12
 as fudge emulsifier, 301
 as gum emulsifier, 300
 hydrophilic-lipophilic balance value of, 251, 286
 as infant nutritional product emulsifier, 239, 240, 245, 251–253
 effect on heat stability, 252–253
 protein interactions of, 251–252
 as margarine emulsifier, 343
 as mayonnaise emulsifier, 387, 388, 389
 modified, 27–28
 natural, hydrophilic-lipophile balance values of, 240
 as pan sprays, 282
 phospholipid components of, 169, 181, 184–185, 240, 251–252
 structure of, 28
 plant sources of, 27
 polar head groups of, 5
 as processed cheese emulsifier, 216–217
 as puff pastry dough emulsifier, 320
 as reduced-fat/low-fat spreads emulsifier, 322
 as release agent, 304
 sources of, 240, 288
 soy-based
 as chocolate emulsifier, 7
 commercial preparation of, 27
 composition of, 240, 288
 hydrophilicity of, 184–185
 modification of, 240
 phospholipid components of, 179, 181, 184–185
 phosphorus analysis of, 47–48
 structure of, 12
 structure of, 12, 274
 sucrose-modifying activity of, 64
 surface-active components of, 288–289
 synthetic, 291–293
 as chocolate and compound coatings emulsifier, 291–293
 as confectionery emulsifier, 285–286
 as toffee emulsifier, 301
 water/oil interface orientation of, 2
- Licorice, 299, 302–303
- Light, as oxidation catalyst, 325
- Light microscopy, of starch/surfactant interactions, 81
- Linoleic acid, 4
 structure of, 311
- Linseed oil, composition of, 313
- Lipase, 149–150
- Lipid chemistry, of bakery emulsifiers, 264

- Lipids**
as flour component, 266
interaction with emulsifiers, 272, 275–276
mass spectrometric analysis of, 54
polar, 94
aqueous solubility of, 110
interfacial interaction with surfactants, 114–144
phase behavior of, 94–97
- Lipogel technology, 345–346
- Lipolysis, 149–150, 151
- Lipophilic functional groups, of emulsifiers, 12–13
- Liposomes. *See* Vesicles (liposomes)
- Liposomes (vesicles), 76, 399
- Liquid-air interfaces. *See* Foam
- Liquid-crystalline nanoparticles, 154–155
- Liquid-crystalline phases
lipid-based cubic, 150–156
of lipid emulsifiers, 180
of polar lipids, 94–97
- Liquid crystals. *See* Mesophases, of emulsions
- Liquid-liquid interfaces, 129–135
- Lovibond method, of color determination, 48
- Low-density lipoprotein (LDL) cholesterol, 312
- Low-fat food products. *See* Fat-reduced food products
- Low-fat spreads, 309–310
- Lysolecithin, 185
complex formation with amylose, 76
synthesis of, 27
- Lysophosphatidylcholine, interaction with proteins, 105–106
- Lysophosphatides
as lecithin component, 181
phase diagram of, 183
- Lysophosphatidylcholine, phase diagram of, 183
- Lysozyme, binding with sodium dodecylsulfate, 98–99
- M**
- Maillard browning products, 300
- Maillard reactions, 154
- Maize starch
differential scanning calorimetry parameters, 79
effect of emulsifiers or complexing agents on, 66, 67, 68, 69
gelation-related viscosity profile of, 72
viscosity parameter for, 75, 76
- Marangoni effect, 115, 116
- Margaric acid, 307
- Margarine, 307–326. *See also* Spreads
cholesterol-reducing effect of, 342–343
comparison with butter, 307–309
consumption rates for, 308–309
definition of, 307, 309
emulsifiers for, 317–323
in industrial cake and cream margarine, 318–319
in industrial fillings, 317, 321
in puff pastry, 320
in reduced-/low-fat spreads, 317, 321–323
fat content of, 342
fat crystallization in, 312, 314–317
full-fat, 342
functionality of, 342
historical perspective on, 341–342
invention of, 1, 307, 341, 389
method of preparation of, 350
microbiological contamination of, 323–325
microstructure of, 341–342
as oil-in-water emulsion, 342
opposition to use of, 307–308
plasticity of, 316
in puff pastry dough, 320
rheological properties of, 307
stabilization of, 350
as water-in-oil emulsion, 310, 317, 349, 350, 389
- Masa harina flour, 67
- Mass spectrometry, 48, 54
in combination with high performance liquid chromatography, 48
- Mass spectroscopy, 398–399
- Matrix-assisted laser desorption ionization, 54
- Mayonnaise, 1, 387, 388, 389
- Meat products, fabricated, 349, 350
- Mège-Mouriès, Hippolyte, 1, 307, 341
- Melittin, 149
- Membrane emulsification, 344
- Mesomorphic phases, 400
nuclear magnetic resonance analysis of, 56
- Mesophase-forming emulsifiers, competition with saccharides, 64
- Mesophases, of emulsions
critical packing parameter, 6
cubic phase, 96–97
geometric forms, 5–6
hexagonal phase, 96
lamellar phase, 96
of monoglycerides, 345–346
in starch/surfactant complex formation, 76
X-ray diffraction studies of, 96

- Metal ions, spectroscopic detection of, 56
- Methanol, use in emulsifier extraction, 39
- Micelles
 - critical concentration of, 94, 174
 - in starch/surfactant complex formation, 76
- Microbiological contamination, of margarine and spreads, 323–325
- Microfluidic devices, 344
- Microfluidization, 354
 - of infant nutritional products, 236–237
- Microscopy, of starch/surfactant interactions, 81
- Milk
 - composition of, 195, 196
 - concentrated, 221–222
 - conversion to dairy products, 195
 - evaporated, 221–222
 - “growing up,” 235
 - heat stability, 219
 - homogenized, 387
 - method of preparation, 350
 - as oil-in-water emulsion, 349, 350
 - raw, shelf life of, 195
 - recombined, 219–221, 236
 - stabilization mechanism for, 350
 - whey:casein ratio in, 223–234, 233–234
 - whey protein content of, 238
- Milk chocolate
 - Casson plastic viscosity of, 294–295
 - viscosity of, effect of lecithin on, 292
 - yield values of, 294
- Milk fat, sedimentation value of, 291
- Milk fat globule membrane, 195
 - heat stability and, 222
 - phospholipids in, 57
 - in whipped cream, 329
 - as whipping cream stabilizer, 205–206
- Milk protein allergy, 234
- Milk protein concentrate, 248
- Milk proteins
 - adsorption studies of, 197–198
 - as emulsifiers, 243–244, 391
 - heat-related denaturation of, 249
 - in ice cream, 335
 - in infant nutritional products, 238, 245, 246, 247–249, 249
 - in margarine, 343
 - in non-dairy whipped cream, 331
 - emulsifying characteristics of, 247
 - hydrolyzed, as infant nutritional product emulsifiers, 245, 246, 250
 - interaction with diglycerides, 253
 - non-hydrolyzed, as infant nutritional product emulsifier, 245, 246, 247–249
- Milk solids non-fat, as non-dairy whipped cream component, 330–331
- Minerals, as food additives, 327
- Moisture
 - as chocolate component, 286–287
 - as compound coating component, 286–287
 - in food surfactants, 46–47
- Moisture analysis, 46–47
- Monoacylglycerides, structure of, 310–311
- Monoacylglycerol(s), 64
 - acetylated
 - acid value of, 42
 - synthesis of, 22
 - as anionic emulsifiers, 13
 - high pressure liquid chromatographic analysis of, 53
 - organic acid-based modification of, 41
 - in starch gelatinization, 71
 - synthesis and commercial preparation of, 14, 15–16
- α -Monoacylglycerol
 - reaction with periodic acid, 41–42
 - structure of, 41–42
 - wet chemical analysis of, 41–42
- Monoacylglycerol phosphate, phosphorus analysis of, 47–48
- Monoclycerols. *See* Monoglycerides
- Monoglycerides
 - acetic acid esters of, as whipped topping emulsifier, 208
 - acetylated, 269, 270
 - amylose-complexing index value of, 302
 - as chocolate and compound coating emulsifiers, 299
 - as confectionery emulsifiers, 285–286, 303–304
 - as gum emulsifiers, 300
 - as release agents, 303–304
 - in aqueous solutions, 201
 - as bakery emulsifiers, 268–269, 344
 - effect on shelf life, 344
 - as caramel emulsifiers, 301
 - as chemically-leavened products emulsifiers, 279
 - as chocolate and compound coatings emulsifiers, 298
 - citric acid esters of, as infant nutritional product emulsifiers, 239, 240
 - as cookie dough emulsifier, 280
 - as crumb softeners, 278
 - distilled
 - as industrial filling emulsifiers, 321
 - as margarine emulsifiers, 317, 320
 - distilled saturated, 322, 345

- as whipped topping emulsifiers, 208
 - distilled unsaturated, as whipped topping emulsifiers, 208
 - ethoxylated, 270, 277
 - commercial preparation of, 26
 - as cookie dough emulsifier, 280
 - as starch-based candy emulsifiers, 302
 - in fat-free bakery products, 282
 - as fudge emulsifiers, 301
 - as ice cream emulsifiers, 203, 204
 - crystalline phase behavior of, 201
 - as infant nutritional product emulsifiers, 239, 240, 253–254
 - lactic acid derivatives of, as confectionery emulsifiers, 285–286
 - lactic acid esters of
 - as chocolate and compound coating emulsifiers, 298–299
 - as whipped topping emulsifiers, 208
 - lactylated, 269, 270
 - as margarine emulsifiers, 319
 - mesophases of, 345–346
 - novel applications of, 224
 - polyoxyethylene, 270
 - as processed cheese emulsifiers, 216
 - saturated
 - as ice cream emulsifiers, 336, 338
 - as zero-fat ice cream emulsifiers, 339–341
 - separation of, 40
 - structure of, 5, 270
 - succinylated, 269, 270, 277, 278
 - as cookie dough emulsifiers, 280
 - succinylated, as cookie dough emulsifiers, 280
 - synthesis and commercial preparation of, 14–16
 - as toffee emulsifiers, 301
 - unsaturated
 - as ice cream emulsifiers, 336, 337, 338
 - as zero-fat ice cream emulsifiers, 341
 - α -Monoglycerides, synthesis and commercial preparation of, 16
 - Monoglycerols
 - gas-liquid chromatographic analysis of, 51–52
 - hydration repulsive forces on, 179, 180
 - lamellar phase of, 179, 180
 - α phase of, 179
 - β phase of, 179
 - solution properties of, 179, 180
 - water/oil interface orientation of, 2
 - Monoolein, lipolysis of, 150, 151
 - Monoolein-aqueous cubic phases, 150–152, 153, 154
 - Monoolein-cytochrome c aqueous system, 152
 - Monopalmitin, 274
 - Mustard, as mayonnaise stabilizer, 388, 389
- N**
- Nanoparticles, liquid-crystalline, 97
 - Nanotechnology, 154–156
 - Napoleon III, 341
 - National Academy of Sciences, 39
 - Natural food products, emulsifiers for, 4
 - Naturally-occurring compounds, modification of, 26–29
 - Near-infrared reflectance, 17
 - Near-infrared spectroscopy, 56
 - Nitrogen, as oxidation preventive, 324
 - Nonionic emulsifiers
 - interaction with proteins, 119
 - structure of, 11, 12
 - Nonpolar lipids, 94
 - Nougats, 303
 - Nuclear magnetic resonance, 56–57
 - Nutritionally-enhanced foods, 327, 346, 399
 - Nutritional molecules, modulation of, 399
- O**
- Obesity, 396–397
 - Octaglycerol monooleate, as compound coating emulsifier, 299
 - Octaglycerol monostearate, as compound coating emulsifier, 299
 - Oiling out, in low-fat spreads, 323
 - Oils
 - emulsifiability of, 173
 - as margarine component, 307, 310–312
 - physical properties of, 310–312
 - Oleic acid, 4
 - structure of, 311
 - Oleolinoleostearin, structure of, 311
 - Omega-3 fatty acids, 310
 - Ostwald ripening, 89
 - Oxidation. *See also* Rancidity
 - in margarine and spreads, 324–325
- P**
- Packing parameter, 94–96
 - Palmitic acid, 4, 307, 314
 - Palm kernel oil
 - as chocolate and compound coating emulsifier, 298
 - composition of, 313
 - crystal kinetics of, 314

- Palm kernel oil (*cont.*)
 fat bloom on, 296–297
 sedimentation value of, 291
- Palm oil, 282–283
 composition of, 313
- Pan sprays, 282
- Parenteral milk products, 219
- Pasta, extruded, 281
- Pasteurization, 1–2
 of ice cream, 197, 335
- Pea flour, 67
- Peanut butter, prevention of oil separation in,
 7–8
- Pentosan, as wheat flour component, 266
- PEO26, 124
- PEO99, 124
- pH
 effect on microbial growth, 323, 324
 effect on molten globule state, 92, 93
 effect on oxidation, 324–325
 effect on starch/surfactant complexes,
 75–76
 of emulsifiers, 11
- Phase behavior
 of emulsifiers, 93–97
 of emulsions, 398–399
 packing parameter of, 94–96
 of protein/emulsifier systems, 108–109
- Phase diagrams, 177–185
 lamellar phase/emulsion stability
 relationship, 177
 lecithins, 179, 181
 lysophospholipids, 183
 mixtures of phosphatides, 183–185
 monoglycerides, 179
 phosphatidic acid, 183
 phosphatidylcholine, 181
 phosphatidylethanolamine, 181, 182
 phosphatidylinositol, 182, 183
 relationship to emulsion stability, 177–185
- Phase-inversion temperature, 186–187, 189
- Phosphated monoglycerides, as confectionery
 emulsifiers, 285–286
- Phosphatide mixtures, phase diagrams of,
 183–185
- Phosphatidic acid
 as lecithin component, 181
 phase diagram of, 183
- Phosphatidylcholine
 dioleoyl, phase diagram of, 184
 as lecithin component, 179, 181, 274
 nuclear magnetic resonance analysis of, 56
 phase diagram of, 181
 plasma protein adsorption values of, 192
 soybean, phase diagram of, 184, 185
 structure of, 11, 288
- Phosphatidylethanolamine
 dioleoyl, phase diagram of, 184
 as lecithin component, 181, 274
 in liquid-crystalline phase formation, 181, 182
 phase diagram of, 181
 plasma protein adsorption values of, 192
 structure of, 11
 unsaturated soybean, phase diagram of,
 184, 185
- Phosphatidylinositol
 as lecithin component, 181, 274
 phase diagrams of, 183, 184, 185
 soybean, phase diagram of, 184, 185
 structure of, 11
- Phosphatidylserine
 as lecithin component, 181, 274
 structure of, 11
- Phospholipids
 egg yolk-derived, interaction with
 cytochrome c, 122–124
 as emulsifiers, 195
 high-pressure liquid chromatographic
 separation of, 52
 high-pressure liquid chromatography/mass
 spectrometry analysis of, 55
 as lecithin component, 169, 181, 184–185,
 240, 251–252
 as milk fat globule membrane component, 195
 nuclear magnetic resonance analysis of, 57
 quantitative analysis of, 48
 separation methods for, 40–41
 structure of, 11
- Phosphorus, analysis of, 47–48
 spectroscopic analysis, 55
- Physical properties, of starch/surfactant
 complexes, 76–81
 analysis of
 with differential scanning calorimetry,
 79–80
 with electron spin resonance, 77–78
 with infrared spectroscopy, 77
 of microstructure of starch systems, 81
 with X-ray diffraction analysis, 77
 rheological properties, 80–81
- Physicochemical aspects, of emulsifiers,
 174–194
 emulsifier surface, 190–193
 associative adsorption-based layer, 190,
 191–192
 competitive adsorption-based layer,
 190–191
 layers adsorption-based layer, 190, 192

- hydrophilic-lipophilic balance values, 187–188
 - calculation of, 187
 - comparison with geometry of molecules, 188
 - definition of, 187
 - limitations of, 188
- phase diagrams, 177–185
 - lamellar phase/emulsion stability relationship, 177
 - lecithins, 179, 181
 - lysophospholipids, 183
 - monoglycerides, 179
 - phosphatidic acid, 183
 - phosphatidylcholine, 181
 - phosphatidylethanolamine, 181, 182
 - phosphatidylinositol, 182, 183
 - relationship to emulsion stability, 177–185
 - role of emulsifiers in homogenization, 189–190
 - solution properties, 175–177
- Physicochemical factors, affecting emulsion structure, 89–90
- “Plastic” consistency, of emulsions, 5
- Polar functional groups, of emulsifiers, 11, 12, 13
- Polar head groups, of emulsifiers, 13
- Polar lipids, 94
 - aqueous solubility of, 110
 - interfacial interaction with surfactants, 114–144
 - phase behavior of, 94–97
- Polyglycerate 60, as starch-based candy emulsifier, 302
- Polyglycerol esters
 - as emulsifiers
 - in cake margarine, 319
 - in compound coatings, 299
 - in confectionery, 285–286
 - in fat-free bakery products, 282
 - in zero-fat ice cream, 341
 - polymerization value of, 4
- Polyglycerol monoesters, high-pressure liquid chromatographic analysis of, 53
- Polyglycerol monostearate, 273
- Polyglycerol polyesters, high-pressure liquid chromatographic analysis of, 53
- Polyglycerol polyricinoleate
 - as chocolate and compound coating emulsifier, 7, 293–295
 - as confectionery emulsifier, 285–286
 - in combination with lecithin, 294–295
 - comparison with lecithin, 294
 - effect on compound coating viscosity, 287
 - as margarine emulsifier, 343–344
 - structure of, 293, 294
 - sucrose-modifying activity of, 64
- Polyhydric emulsifiers, 270–271, 273
- Polyol, analysis of, 52
- Polyoxyethylene sorbitan monostearate, 271, 277
- Polyoxyethylene (20) sorbitan monostearate.
See Polysorbate 60
- Polyoxyethylene sorbitan tristearate, 271, 277
- Polypylene glycol alginate, high-pressure liquid chromatographic analysis of, 53
- Polsaccharides, chemically-modified, 82
- Polysorbate(s)
 - chromatographic analysis of, 52–53
 - as fat-free bakery product emulsifiers, 282
 - as ice cream emulsifiers, 202, 336, 337, 338
 - nomenclature of, 25
 - spectroscopic analysis of, 55
 - synthesis and commercial preparation of, 25–26
 - water as component of, 46–47
- Polysorbate 60
 - amylose-complexing index value of, 302
 - as anti-fat bloom agent, 298
 - as crumb softeners, 279
 - as emulsifiers
 - in bakery products, 270, 271, 277
 - in cakes, 280
 - in confectionery, 286
 - in cookie dough, 280
 - in cream icings, 281
 - in salad dressings, 5
 - hydrophilic-lipophilic balance of, 286
- Polysorbate 65, 271
- Potato starch, 64
 - differential scanning calorimetry parameters, 79
 - dynamic modulus, 80
 - gelation-related viscosity profile, 73
 - interaction with emulsifiers or complexing agents, 66, 67, 68, 69
 - interaction with glycerol monostearate, 75
 - viscosity parameter for, 75, 76
- Powdered products
 - coffee whiteners, 214–215
 - emulsifiers for, 264
 - milk, 220–221
- Pregnant women, nutritional preparations for, 235
- Probiotic cultures, 310

- Pro-oxidants, spectroscopic detection of, 56
- Propofol, 155
- Propylene glycol, as humectant, 64
- Propylene glycol alginate, 82, 241
 structure of, 29
 synthesis of, 28
- Propylene glycol esters
 gas-liquid chromatographic analysis of, 51–52
 synthesis of, 16–17
 as whipped topping emulsifier, 208
- Propylene glycol monoesters, 269, 270
 as chocolate and compound coating emulsifiers, 299
 as confectionery emulsifiers, 285–286
 as crumb softener, 280
- Propylene glycol monostearate, as whipped topping emulsifier, 208
- Protein(s)
 adsorption kinetics of, 192, 379–382
 in homogenized whipped cream, 331
 in whipped cream, 329
 as “all natural” emulsifiers, 4
 denaturation of, 11
 destabilization of, 5
 effect on emulsions’ shelf life, 349
 effects on emulsion formation, 379–387
 as flour component, 265, 266
 interaction with emulsifiers, 272, 275
 hydrolyzed, in infant nutritional products, 234
 in infant nutritional products, 234, 235, 238–239
 interfacial rheology of, 381–382
 interfacial shear viscosity of, 382, 383
 isoelectric point of, 11
 lecithin-induced surface displacement of, 252
 microparticulated, 339, 345
 milk content of, 195, 196
 molten globule state of, 92, 93
 as nutrient for micro-organisms, 324
 in reduced-fat and low-fat spreads, 322
 stability of, 5, 91–93
 effect of hydrogen bonding on, 91
 effect of van der Waal’s forces on, 91, 93
 hydrophobic interactions in, 91, 92
 structure of, 5, 91
 surface activity of, 5, 174
 water/oil interface orientation of, 2
- Protein/emulsifier interactions, 8, 89–171, 90–93, 349
 applications of, 144–156
 enzyme activity and, 149–150
 in food and pharmaceutical systems, 145–148
 in nanotechnology, 154–156
- binding in
 isotherms for, 98–99
 specific, 98, 99–101
- influence of emulsifier properties on, 118–144
 aqueous soluble-surfactant type, 119–120
 electrostatic forces, 120–123
 lipids with low aqueous solubility, 120–124
 liquid-air interfaces (foams), 136–141
 liquid-liquid interfaces, 129–135
- at interfaces, 114–144
 effect of protein film structure on, 124–126
 effect of surface properties on, 126–144
 emulsifiers with low solubility, 141–144
 lipids with low aqueous solubility, 120–124
 liquid-liquid interfaces, 129–141
 solid-liquid interfaces, 126–129
 surface activity effect in, 117
 thin-film instability in, 115, 116
 Vroman effect in, 117–118
- protein structure and stability factors in, 90–93
 emulsifier phase behavior, 93–97
- in solution, 93–114
 anionic emulsifiers, 102–105
 aqueous soluble-surfactant emulsifiers, 97–107
 cationic emulsifiers, 106
 emulsifier phase behavior, 108–109
 emulsifiers with low aqueous solubility, 109–114
 ionic emulsifiers, 105–106
 lipid-aqueous interface curvature, 111–114
 nonspecific cooperative interactions, 98, 102–106
 specific binding activity, 98, 99–101
- Proteocubosomes, 155–156
- Puff pastry dough, margarine plasticity in, 316
- Puff pastry margarine
 emulsifiers for, 320
 production of, 320
- Q**
 Quality descriptor analysis, 58
- R**
 Rancidity
 linoleic acid-related, 4
 in margarine and spreads, 324
 of unsaturated fatty acids, 43, 44

- Rapeseed oil
 composition of, 313
 oxidation of, 324
- Reduced-fat food products. *See* Fat-reduced food products
- Refractive index, 17, 49
- Regulated Direct Additives, 3, 389–390
- Regulations, affecting emulsifier use, 3–4
 of European Economic Community
 for bakery emulsifiers, 266
 for food emulsifiers, 3, 4
 for infant nutritional products, 239–240
 of Food and Drug Administration (FDA)
 Direct Food Additives, 3, 389–390
 Generally Recognized as Safe (GRAS), 3, 389, 390
 for trans fatty acids, 397
 for infant nutritional products, 239–240
 variability in, 2
- Reichert-Meisel value, 46
- Release agents, 282
 amylose/lipid complexes as, 80–81
- Response surface methodology (RSM), 8
- Retrogradation, of starch, 68, 69, 72–73, 81, 274
- Reynolds numbers, 356, 357, 360, 362
- Rheological properties, of starch/surfactant complexes, 80–81
- Rice starch, 68
- Ricinoleic acid, 18
- Rosemary extract, 325
- S**
- Saccharides. *See also* Sugars
 simple, functions of, 63–64
- Salad dressings. *See also* Mayonnaise
 creamy, 5
 shelf life, 1
- Salts
 effect on fat emulsifier spattering, 344
 effect on microbial growth, 323, 324
 effect on oxidation, 324
 emulsifying, 215–217
- Saponification, 52
- Saponification value, 44–45
- Sauces, as oil-in-water emulsions, 349, 350
- Scanning electron microscopy, 81, 82
 of ice cream, 198–199
 of whipped cream, 204, 205
- Sedimentation volume, 175
- Sediment volume, of settling particles, 173
- Shear flow, droplet breakage in, 356–357, 358, 359
- Shear-gelled systems, 345
- Shear stress, in droplet breakage, 354, 355–367
- Shelf life
 effect of proteins on, 349
 of emulsions, 349
 of margarine and spreads, 323–325
 relationship to emulsion drop size, 349
- Shortenings
 for baked products, 263–264, 265, 267–268, 282–283
 compound, 263
 definition of, 263
 emulsifiers in, 263, 265
 history of, 263
 nonemulsified, 265
 nuclear magnetic resonance analysis
 of, 56
 plasticity of, 267–268
 trans-fatty acid free, 282–283
 votation of, 267
- Skim milk, heat stability of, 221–222
- Skim milk powder, 220, 221
 casein in, 248
- Skim milk proteins, heat-related denaturation
 of, 249
- Slip point, 49
- Snacks, extruded, 281
- Soaps
 of fatty acids, 47
 monoglyceride-stabilizing effects of, 179
 use in sucrose ester synthesis, 20
- Sodium alginate, 7
- Sodium caseinate, 245, 248, 249, 340
 as coffee whitener stabilizer, 215
 as cream liqueur component, 211, 212
- Sodium dodecane sulfonate, 119
- Sodium dodecylsulfate
 interactions with proteins, 97–99, 103–105, 106–107
 binding isotherms for, 98–99
 with bovine serum albumin, 128
 effect of surface charge on, 128, 129
 α -helical structure in, 103–104
 at hydration surfaces, 119
 with β -lactoglobulin, 118
 with lysozyme, 106, 108–109, 119
 necklace model for, 104
 nonspecific cooperative interactions, 102
 as processed cheese emulsifier, 216–217
 starch-destabilizing effect of, 71–72
- Sodium lauryl sulfate, 272
- Sodium salts, of fatty acids, 47
- Sodium stearyl fumarate, 272
 as coffee whitener stabilizer, 215
 as cookie dough emulsifier, 280

- Sodium stearoyl lactylate, 64, 272
 as coffee whitener stabilizer, 215
 as crumb softener, 279
 effect on starch gelatinization, 71, 72, 274
 effect on starch paste viscosity, 71
 as emulsifier
 in bakery products, 277, 344
 in cake, 280
 in coffee whiteners, 224
 in cookie dough, 280
 in cookies and crackers, 281
 in extruded snacks/cereals, 281
 residual peroxides in, 44
 structure of, 5, 20
- Sodium stenoil-2-lactylate, effect on starch
 pasting characteristics, 302
- Solid fat content, nuclear magnetic resonance
 measurement of, 56
- Solubility, of emulsifiers, 185–186
 comparison with emulsifiability, 186
- Solubilization, free energy of, 175
- Sorbates, mass spectrometric analysis of, 54
- Sorbitan(s)
 as bakery emulsifier, 269, 270, 271
 chromatographic analysis of, 52
 nomenclature of, 25
- Sorbitan esters
 in associative adsorption, 192
 as confectionery emulsifiers, 285–286
 ethoxylated, in associative adsorption, 192
 in fat-free bakery products, 282
- Sorbitan monostearate
 amylose-complexing index value of, 302
 as anti-fat bloom agent, 298
 as cake emulsifier, 280
 as cookie dough emulsifier, 280
 residual peroxides in, 44
 synthesis of, 18–19
- Sorbitan tristearate
 as anti-fat bloom agent, 297
 as reduced-fat/low-fat spread emulsifier,
 322–323
- Sorbitan tristearate esters, crystal kinetics of,
 315
- Sorbitol
 chromatographic analysis of, 52
 cyclization and esterification of, 19
 as humectant, 64
- Soxhlet extraction apparatus, 39
- Soybean oil
 composition of, 313
 as lecithin source, 271. *See also* Lecithins,
 soy-based
 oxidation of, 324
 as shortening source, 280
- Soybeans, as biofuel, 400
- Soy protein, in infant nutritional products,
 234, 235, 239, 251
- Special populations, nutritional products for,
 398
- Specific gravity, 50
- Spectrophotometry, 48
- Spectroscopic methods, 55–56
- Spray drying, of infant nutritional products, 237
- Spreads
 definition of, 307
 differentiated from margarine, 309
 emulsifiers in, 317–323
 fat crystallization in, 312, 314–317
 low-fat/very-low fat, 343–345
 reduced-fat, 309–310, 321–323
 zero-fat, 345–346
- Stability/stabilization, of emulsions and
 foams, 399
 of dispersions, 175
 effect of liquid-crystalline phases on, 178
 effect of processing conditions on, 1–2
 mechanisms of, 115–116, 381–387
 phase diagrams, 177–185
 lamellar phase/emulsion stability
 relationship, 177
 lecithins, 179, 181
 lysophospholipids, 183
 monoglycerides, 179
 phosphatidic acid, 183
 phosphatidylcholine, 181
 phosphatidylethanolamine, 181, 182
 phosphatidylinositol, 182, 183
 relationship to emulsion stability,
 177–185
- Stabilizers, 190
 classification of, 390–391
 for cream liqueurs, 211–212
 for ice cream, 335
 for infant nutritional products, 241,
 245–246, 255
- Stanol esters, as component of spreads,
 309–310
- Staphylococcus aureus*, cell permeability of,
 63–64
- Starch
 as candy base, 301–303
 differential scanning calorimetry
 parameters of, 79
 effects of external lipids on, 65–74
 enzymolysis of starch, 68, 73–74
 iodine binding capacity, 66, 69, 70
 starch gelatinization, 66, 67, 68, 71–72

- starch pasting, 66, 67, 69, 70–71
- starch retrogradation, 68, 69, 72–73
- enzymolysis of, 68, 73–74
- in flour, interaction with emulsifiers, 272, 274–275
- as flour component, 265, 266
- gelatinization of, 274
- as glucose source, 397
- as infant nutritional product stabilizer, 241
- microstructure of, 81
- modified, in infant nutritional products, 241
- retrogradation of, 68, 69, 72–73, 274
- structure of, 75, 274
- viscosity parameter, 75, 76
- Starch granules/molecules
 - in lipid/surfactant complexes, 74–75
 - structure of, 64
 - types of, 64
- Starch octenyl succinate anhydride, 241, 255
- Starch pasting, 66, 67, 69, 70–71
- Starch-reduced foods, 397
- Starch sodium octenyl succinate, 239, 240
- Starch/surfactant complexes, 64–65
 - lipid adjunct and surfactant properties of, 74–76
 - physical properties of, 76–81
 - differential scanning calorimetry of, 79–80
 - electron spin resonance of, 77–78
 - infrared spectroscopy of, 77
 - microstructure of starch systems, 81
 - rheological properties, 80–81
 - X-ray diffraction analysis of, 77
 - relative thermal stability of, 80
- Stearic acid
 - as margarine component, 307
 - structure of, 311
- Steric forces, 89
- Sterilization, of infant nutritional products, 223, 237–238
- Sterols, as component of spreads, 309–310
- Succinylated monoglycerides, 269, 270, 277, 278, 279
 - as cookie dough emulsifiers, 280
- Sucrose, 63
- Sucrose diester, 273
- Sucrose distearate, as cookie dough emulsifier, 280
- Sucrose esters. *See* Fatty acids, sucrose esters of
- Sucrose monopalmitate, as cookie dough emulsifier, 280
- Sucrose monostearate, as cookie dough emulsifier, 280
- Sugar particles, microstructure of, 81
- Sugar-reduced foods, 397
- Sugars
 - functions of, 63–64
 - in ice cream, 335
- Sugar syrup, 299
- Sunflower oil
 - composition of, 313
 - hydrogenated, 315
 - in infant nutritional products, 250
 - oxidation of, 324
- Surface, of emulsifiers, 190–193
 - associative adsorption-based layer, 190, 191–192
 - competitive adsorption-based layer, 190–191
 - layers adsorption-based layer, 190, 192
- Surface-active agents, 264
- Surface activity, of emulsifiers, 173–175
 - definition of, 173
 - Krafft temperature of, 174
 - in protein/emulsifier interactions, 126–129, 140
- Surface properties, in protein/emulsifier interactions, 126–129
- Surface tension measurement, in protein/lipid interactions, 90
- Surfactants. *See also* Emulsifiers
 - in confections, 285
 - definition of, 264
 - effects on emulsion formation, 379–387
 - interfacial shear viscosity of, 382
 - successive solvation of, 176, 177
 - use in bakery products, 266
- Synthesis and commercial preparation, of food emulsifiers, 11–37, 400
 - calcium stearyl lactylate, 21
 - derivatives of monoacylglycerols, 21–25
 - acetylated monoacylglycerols, 22
 - citrate esters of monoacylglycerols (CITREM), 23–24
 - lactylated monoacylglycerols, 23
 - succinylated monoacylglycerols, 23
 - derivatives of monoclycerols
 - diacetyltartaric acid esters of monoacylglycerols (DATEM), 24
 - monoacylglycerol phosphate, 24–25
 - equipment for, 30–34
 - batch esterification/interestification reactors, 30–31
 - bioreactors for esterification and interestification, 32–34
 - continuous interestification reactors, 31–32
 - ethoxylation/propoxylate reactors, 34

- Synthesis and commercial preparation, of food emulsifiers (*cont.*)
- functional group design principles of, 11–13
 - modification of naturally-occurring compounds, 26–29
 - alkyl esters of cellulose, 29
 - modified lecithins, 27–28
 - propylene glycol alginate, 28
 - of monoglycerols and diglycerides, 14–16
 - polyglycerol esters of fatty acids, 17–18
 - polyoxyethylene derivatives, 25–26
 - ethoxylated diacylglycerols, 26
 - ethoxylated monoglycerol, 26
 - polyoxyethylene sorbitan esters (polysorbates), 25–26
 - of propylene glycol esters, 16–17
 - sodium stearoyl lactylate, 21
 - sorbitan monostearate, 18–19
 - sucrose esters, 19–21
 - tristearate, 18–19
- T**
- Tapioca
- differential scanning calorimetry parameters of, 79
 - effect of emulsifiers or complexing agents on, 66, 67, 68
 - gelation-related viscosity profile of, 73
 - viscosity parameter for, 75, 76
- Taro paste, 80
- Tartaric acid, 285–286
- Temperature, effect on starch/surfactant complexes, 75
- n*-Tetradecane-water interface, adsorption kinetics of, 383
- Thermomyces langui*noase, lipase of, 149–150
- Thin films, stabilization/destabilization mechanisms of, 115–117
- Toffee
- emulsifiers for, 285, 299, 300, 301
 - ingredients, 300
- Trans-fatty acid-free food products, 308, 397
- shortening, 282–283
- Trans-fatty acids, 397
- effect on low-density lipoprotein cholesterol, 312
 - formation during hydrogenation, 312
 - labeling regulations regarding, 312
 - structure of, 314
- Transmission electron microscopy, 81
- Trans unsaturated fatty acids, 5
- Triacylglycerols, saponification value of, 45
- Triglycerides
- lipolysis of, 150
 - as nonpolar lipids, 94
 - saturated, removal from whipping cream, 332
 - structure of, 311
- Triglycerol monooleate, as chocolate and compound coating emulsifier, 298–299
- Triglycerol monostearate, as compound coating emulsifier, 299
- Triton X surfactants, interaction with bovine serum albumin, 105
- Turbulent flow, in droplet breakup, 360–364, 365
- isotropic, 365
 - Laplace pressure in, 361–362
 - Reynolds numbers for, 360, 362
 - turbulent stress in, 361–362, 363
 - Weber numbers for, 362
- Tween 20, 125–126
- effect on emulsion gels, 219
 - effect on fibrinogen elution, 119–120
 - interaction with β -lactoglobulin, 90, 99–100
- Tween 60. *See* Polysorbate 60
- U**
- Ultra-high temperature (UHT) processing of recombined milk products, 221
- Ultra-high-temperature (UHT) processing of infant nutritional products, 237
- Ultraviolet light, as oxidation catalyst, 325
- Unilever, 339
- United Kingdom, reduced fat/reduced calorie product sales in, 327
- V**
- van der Waals' equation, applied to drop coalescence, 375
- van der Waals' forces, 89
- effect of lamellar liquid-crystalline phase coating on, 178
 - effect on protein stability, 91, 93
 - in infant nutritional products, 251, 252
- Vegetable fats
- as Kosher-certified emulsifiers, 4
 - as low-fat spread emulsifier, 323
 - as non-dairy whipping cream component, 330
- Vesicles (liposomes), 76, 399
- interactions with proteins, 131–135

- Vicinal hydroxyl groups, 41–42
- Viscoelastic behavior, 367, 382
- Viscometry, 50
- Viscosity
- of chocolate and compound coatings, 286, 287, 289–291
 - of confectionery coatings, 64
 - of confections, 64
 - effect on beverage creaming, 389
 - measurement of, 50, 399
 - in non-Newtonian fluids, 366–367
 - plastic, of chocolate, 287, 289
 - of starch, 70–71
 - temperature-dependence of, 50
 - zero shear rate of, 366–367
- Viscosity behavior, in food formulations, 367
- Viscosity ratios, in droplet breakup, 356–357, 360, 361
- Vitamin K₁, 152, 153
- Vitamins, as food additives, 327
- Votation, of shortenings, 267
- W**
- Water
- addition to surfactants, 46–47
 - bubble lifetime in, 173
 - in ice cream, 335
- Water droplets, effect on microorganisms, 323, 324
- Water droplet size, effect on oxidation, 325
- Weber numbers, 360, 361–362
- Wet chemical analysis, 41–48
- acid value/free fatty acid, 42–43
 - of fatty acid soaps, 47
 - hydroxyl value, 45
 - iodine value (IV), 43
 - lactic acid analysis, 46
 - moisture analysis, 46–47
 - of α -monoacylglycerol, 41–42
 - peroxide value (PV), 44
 - of phosphorus and phospholipids, 47–48
 - Reichert-Meisel value, 46
 - saponification value, 44–45
- Whale oil, as margarine component, 389
- Wheat flour
- composition of, 265, 266
 - interactions with emulsifiers or complexing agents on, 66, 67, 266
 - processing of, 265
 - protein/emulsifier interactions in, 275
- Wheat starch, 64
- differential scanning calorimetry parameters, 79
 - dynamic modulus, 80
 - effect of emulsifiers or complexing agents on, 66, 67, 68
 - gelation-related viscosity profile, 73
 - viscosity parameter, 75, 76
- Whey protein, in infant nutritional products, 245, 250
- Whey protein concentrate, effect on gelation, 218
- Whey protein hydrolysate, in infant nutritional products, 245
- interaction with lecithin, 252–253
- Whey protein isolate, as infant nutritional product emulsifier, 237, 248, 249
- Whey proteins, 391
- emulsifying characteristics of, 247
 - heat-related denaturation of, 222–223, 249
 - in infant nutritional products, 238–239, 249
 - interaction with DATEM, 254
 - in milk, 195
 - in milk protein-based emulsions, 223
- Whipped cream, 204
- cryo scanning electron micrograph of, 204, 205
 - definition of, 204
 - fat-particle coalescence in, 204, 205
 - foam stability of, 8
 - foam structure of, 328–329
 - non-dairy emulsifiers for, 332
 - milk solids non-fat (MSNF) component of, 330–331
 - stand-up properties of, 205, 328–329, 332
 - structure of, 204, 205, 330
- Whipped toppings, 207–210
- foam structure of, 208, 210
- Whipping cream
- definition of, 204, 328
 - emulsifiers for, 206
 - homogenized dairy, 328–330, 331
 - emulsifiers for, 206–207, 331–332
 - interfacial tension of, 206
 - whipping ability of, 204–206
 - whipping time of, 206 - manufacture of, 204, 350
 - non-dairy, 328, 330–331, 332
 - non-homogenized
 - cryo scanning electron micrograph of, 204, 205
 - whipping ability of, 204 - as oil-in-water emulsion, 349, 350
 - recombined, 206–207
 - stability/stabilization of, 204, 350

X

X-ray diffraction analysis, 77

Xylene, with ethoxylated nonyl-phenol,
178

Y

Yeast-raised products, emulsifiers for, 276–279

YN lecithin. *See* Lecithin, synthetic

Yoghurt, 401