

CAGE FARMING AQUACULTURE-E

# Cage Farming Aquaculture

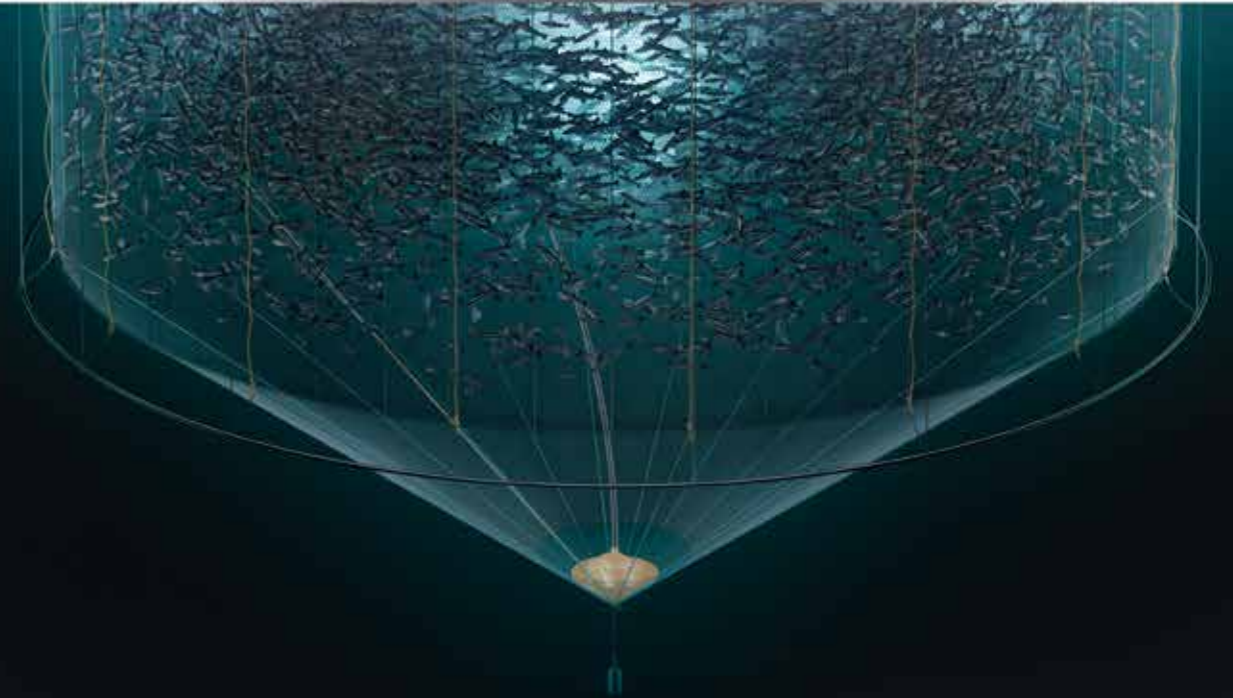

# Your Aquaculture Technology and Service Partner

## C O N T E N T S :

YOUR PARTNER .....	4
CAGE FARMING .....	6
SERVICE .....	10
PRODUCT TRAINING .....	11
RENTAL .....	12
CAGES .....	14
PLASTIC CAGES .....	16
STEEL CAGES .....	22
MOORING SYSTEMS .....	26
FIBRE NETS .....	30
NON FIBRE NETS .....	34
NET CLEANING SYSTEMS .....	36
WORKBOATS .....	46
FEED BARGES .....	54
FEED SYSTEMS .....	72
CAMERA SYSTEMS .....	92
ENVIRONMENTAL SENSORS .....	98
BIOMASS ESTIMATORS .....	108
UNDERWATER LIGHTS .....	110
SOFTWARE .....	116
LAND BASED FARMING .....	128
AQUACULTURE SPECIES .....	134
GLOBAL TRENDS .....	136
WORLDWIDE SALES .....	138

*Certain products and services may not be available in all countries. Please contact a sales representative in your country or region for further details.*

# Reliable and innovative aquaculture solutions combined with professional service and support



**As a partner our mission is to improve your profitability and sustainability.**

During more than 40 years as innovator and provider of technology and services to the global aquaculture industry, we in AKVA group have learned what really matters to our customers as well as to ourselves. Partnerships, good partnerships – enabling us to contribute solutions and services that make our customers successful in developing and operating sustainable and profitable aquaculture operations. Good Partnerships, where our contribution to solutions and services earn us the opportunity to develop AKVA group as a sustainable and profitable company.

We will continue to build AKVA group with this as our mission. We will be focused on our customers' needs, being attentive and responsive. We will develop and use our knowledge to contribute solutions and services that lifts our customers performance.

We will take pride in being reliable and honest in what we do and how we act, and we will use our enthusiasm to generate the energy and joy needed to take our customers as well as AKVA group forward.

In AKVA we strongly believe that we can make a difference. We are proud to be part of the global aquaculture industry which is playing a crucial role providing healthy seafood world wide.

We are partners – and in it for the long run.

**AKVA group is a leading technology and service partner to the aquaculture industry worldwide**

AKVA group is a solid partner with offices and facilities in Norway, Chile, Denmark, Scotland, Iceland, Spain, Greece, Turkey, Iran, Canada and Australia. With 11 offices and several agents and distributors around the globe AKVA group is present in all markets worldwide. AKVA group is a unique partner with the capability to offer both cage farming and land based aquaculture operations with complete technical solutions and service.

The company holds strong, well-known brand names and the product line range from plastic and steel cages, mooring systems, nets, net cleaners, work boats, feed barges, feed systems, camera systems, environmental sensors, underwater lights, production and process control software, recirculation systems, PE piping systems, farm design, on-site services and training courses.

Partnering with AKVA group allows customers to keep their focus on fine tuning farm operations to increase profitability, while sharing the technical challenges with a reliable partner with the right people, the right technology and the right knowledge to achieve excellence.



HALLVARD MURI  
CEO, AKVA group ASA.

## Project planning

Two heads think better than one, says an old proverb. In terms of planning an aquaculture operation it translates into allowing people with different know-how to work together in the planning process. Letting AKVA's technical experts team up with your own operational experts will ensure well founded and correctly dimensioned farming solutions.

## Budgeting

Budgeting means planning years ahead to create an image of the size and shape of your operations. This is imperative to secure adequate financing and proper financial control. Allowing technical considerations into the budget will also help you identify constraints or bottlenecks in your operation.

## Technical solutions

Are you happy with standard solutions or does your operation or managers require fine tuning of some of the hardware? In a carefully planned complete project, specific hardware requirements can be taken into account at an early stage so they won't add extra costs or delays along the way.

## Installations

Plug and play may be the preferred mode for anyone wanting to connect two pieces of equipment together. In an aquaculture facility, putting the pieces together may not be quite as simple, although it might seem like it when our experts are at work. Professional commissioning and start-up will prevent future headaches and costly mistakes.

## Service & support

Systems running year after year, sometimes in extreme weather, will always be subject to extensive wear and tear. In order to maintain reliable operations, preventive service agreements and regular maintenance are critical. AKVA group's Service department has decades of experience in supporting and performing maintenance under such conditions.

## Rental\*

AKVA group offers rental of complete systems as well as single products with service included. We have a very skilled and experienced service network and our new rental agreement allow our customers to focus their attention on feeding fish, while we make sure that the equipment is continuously performing. *\*Not offered in all areas.*

# Cage Farming Aquaculture - Complete Solutions Worldwide

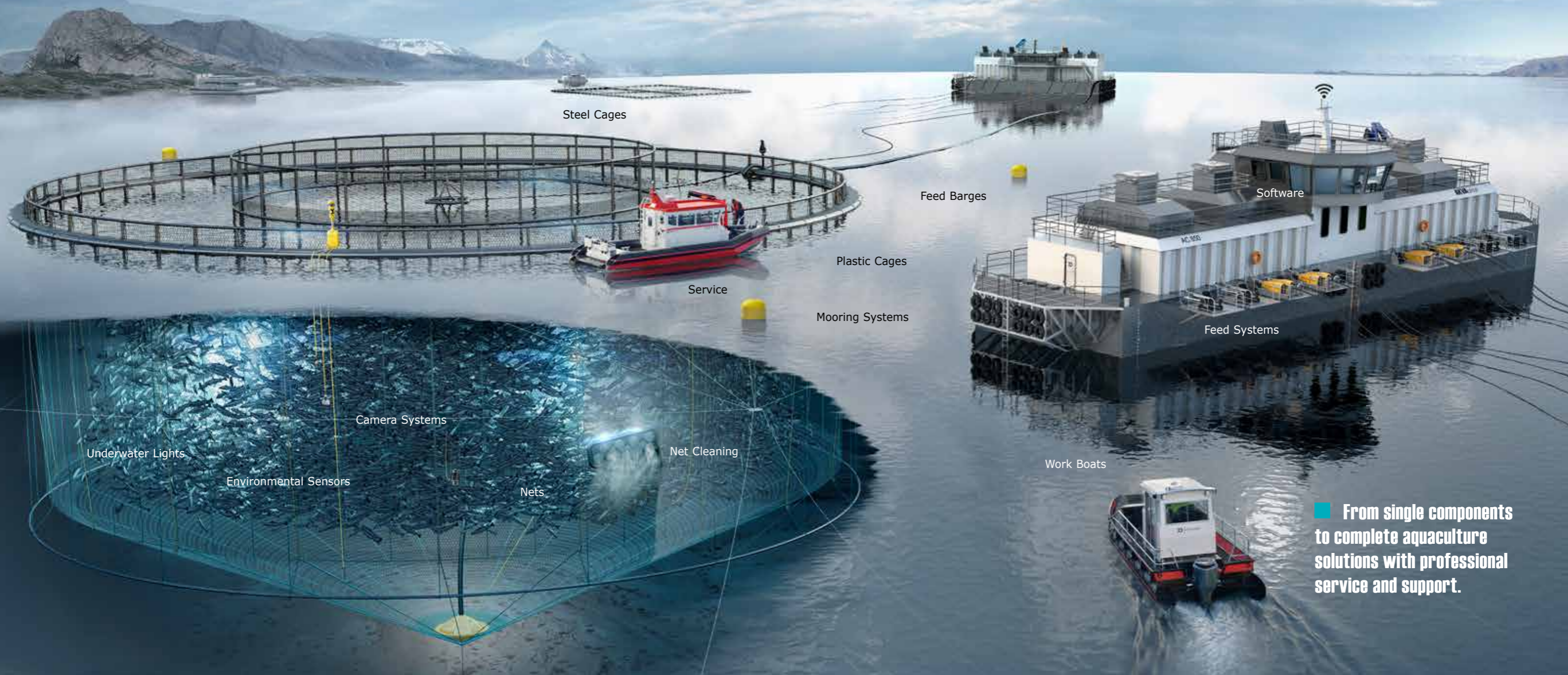

From single components to complete aquaculture solutions with professional service and support.



### Feed Barges

AKVA group is the world's leading supplier of feed barges with decades of experience and nearly 300 barges delivered worldwide.



### Feed Systems

The central feed system was invented by AKVA group in 1980 and Akvasmart CCS is today the world's most popular and reliable feed system.



### Cages

AKVA group is the leading supplier of both plastic and steel cages in aquaculture, and has since 1974 delivered more than 60,000 cages.



### Software Solutions

Fishtalk is a unique IT concept and tool that provides integrated operations and biological production. AKVAconnect is the latest farm operations and technical control software platform.



### Camera and Sensor Systems

Advanced video camera and sensor systems monitor both fish, the feeding process and the environment. This ensures optimum operations and a healthy fish.



### Workboats

The robust Polarcirkel workboats offers great design, quality build, unique flexibility, safety and low maintenance.



# Service, support and training

## Advanced aquaculture needs professional maintenance

As aquaculture equipment becomes more advanced, the need for professional service and preventive maintenance increases. AKVA group offers global professional service on all products.

Through on-site visits, AKVA group technician will get a complete overview and understanding of specific solutions on the site, specific requirements, preferences and work routines of local staff.

Sufficient training of your staff and managers will minimize the amount of frustration that builds up while browsing through a manual in search of a solution to a problem. Training of staff, face-to-face is always a smart investment.

## Rental\*

AKVA group offers rental of complete systems as well as single products with service included. We have a very skilled and experienced service network and our new rental agreement allow our customers to focus their attention on feeding fish, while we make sure that the equipment is continuously performing.

*\*Not offered in all areas.*



# Professional service, maintenance and training

As aquaculture equipment becomes more advanced, the need for professional service and preventive maintenance increases. AKVA group offers global professional service on all products; on or off location including:

- **Fixed pricing on reconditioned critical spare parts with guaranteed local availability.**
- **Technical telephone support during local office hours.**
- **Professional consultancy services.**
- **System upgrades, including fixed pricing on specific rebuild kits.**
- **Fast service response times.**

 **Prioritized 24 hour telephone support**

 **Global professional service on all products**

 **Dedicated AKVA group service representative during office hours**

 **Status report with yearly documentation of the site**

 **Discount on AKVA group training programs**

 **Discount on spare parts**

 **Discount on software upgrades**

*The main overview provides fast access to the present state of the entire system.*

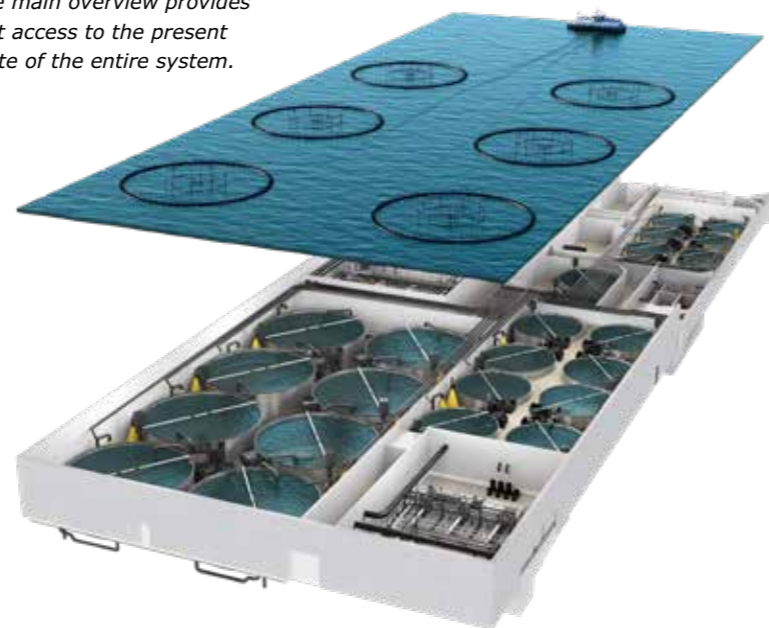

*Software support can include training, online support, consulting, implementation, server control & server security oe.*



**With a service agreement, the farm manager can focus completely on the fish, while our technical staff looks after the equipment.**



*Regular service prevents downtime, and thus ensures predictable and uninterrupted production.*

**Experienced service personnel on-site.**

**Off-line service and support.**

## Regular service



*AKVA group offer a regular service visit with equipment control and maintenance, including detailed status reports.*



## Customized courses



*AKVA group offers a wide range of advanced aquaculture technology, and provides customized product training on demand.*

## Preparing, Training, Follow-up

All training programs are tailor-made and planned in close cooperation with the customer. Further on, and to ensure the highest possible learning outcome, the following stages are followed:

1. **Individual self-paced preparation phase**
2. **Face-to-face training**
3. **Close post-training follow-up**

## Complete remote control



*Turning a software solution into the optimal work tool requires understanding about local knowledge, work routines and preferences.*

1. **On-site support, telephone support, online support**
2. **Implementation**
3. **On-site, in depth training**
4. **Upgrading of licences**
5. **Consulting**
6. **Tailor-made solutions**
7. **Securing long time investments**

## On-site training



*Experienced and highly qualified AKVA group personnel will teach the classes, both at the main courses and out on the customer's locations.*

**Well trained employees is a smart investment. It will improve the results and reduce down time.**



AC 600 PV with V-bottom

## Rental agreements with professional service and support included\*

### Equipment Renting - More effective performance

AKVA group Services rental concept is offered for a number of products such as e.g. feed systems, feed accessories, camera systems, environmental sensors, infrastructure, dead fish systems, underwater lights, washing systems, subsea feeder, etc.

The rental concept has been developed in cooperation with our customers, and it is evident that more and more customers prefer rental instead of traditional purchase. Much of the reason for this is peace of mind and fixed monthly costs.



*A rental agreement allows you to give the fish priority, while AKVA group ensures optimum functionality and operation of the systems. A rental agreement gives you the most modern equipment.*

### A rental agreement may include:

- Transport of complete rental equipment\*\*
- Installation and start-up
- Training in using the system
- Service and support of the rental equipment is included, which ensures high uptime and optimum configuration
- Repairs or replacement of defective equipment free of charge
- Fixed price for the entire rental period
- No front-end fee
- Free access to support

The customers may themselves choose between several different rental periods that may be individually customized. Rental agreements from 2-8 years. Our aim is that you will have state of the art equipment at all times and as worry-free operations as possible.

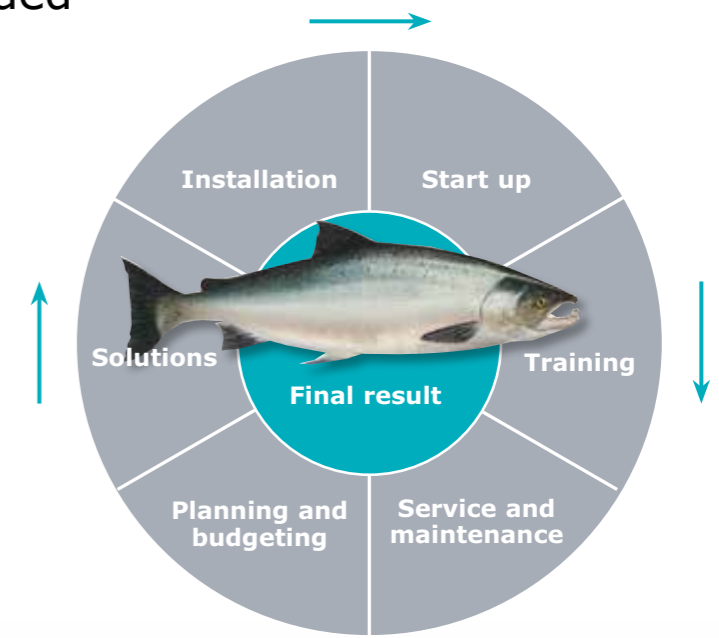

**■ A regular purchase gives you a quality product. If you rent, you're paying for a successful outcome.**

\* The rental agreement is not available in all areas.

\*\* Transport costs may vary.



## Cages

### The world's leading cage supplier

AKVA group is the world's leading supplier of both plastic and steel cages. Polarcirkel, the most recognized brand in aquaculture, invented the plastic cage concept in Norway in 1974, and has since supplied more than 45,000 cages worldwide. The renowned Wavemaster steel cages originated in Ireland in 1985, and more than 15,000 cages have since been delivered globally.

In order to ensure the highest possible quality, competitive pricing and on-time deliveries, the cages and components are manufactured in many different regions. All cages are installed by professional installation teams, and serviced by professional AKVA group service technicians.

AKVA group invests heavily in innovative and professional R&D in order to remain the leading supplier of cages, not only to improve products in the short term, but also to look into the future of tomorrow's demands for cage technology.



# Polarcirkel All-Plastic-Cages



Polarcirkel PE brackets are tested in arctic areas to withstand extreme cing such as here in Russia.

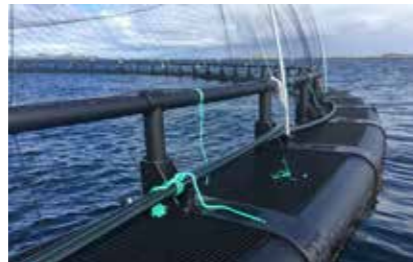

The new "flagship" Polarcirkel 630, have 63 cm circumference on the floating pipe and up to 240 metres across the cage.

Experience is a crucial success factor in the fish farming business. AKVA group (Polarcirkel) invented the plastic cage in 1974, and has since then supplied more than 45.000 Polarcirkel Cages and 15.000 Polarcirkel Boats. The cages are made from PE raw materials especially suited for the dynamic loads of the sea, and are available in a wide range of models, shapes and sizes to suit individual needs.



Most plastic cages are moored in a grid system and include sinker tube, centersupport stand, feed system/ barge, cameras and sensors.

All Polarcirkel Cage designs are carried out by our professional T&D department. Independent marine engineering consultants are also involved in advanced static and dynamic load calculations to ensure all designs meet or exceed expected real life loads as well as applicable industry standards.

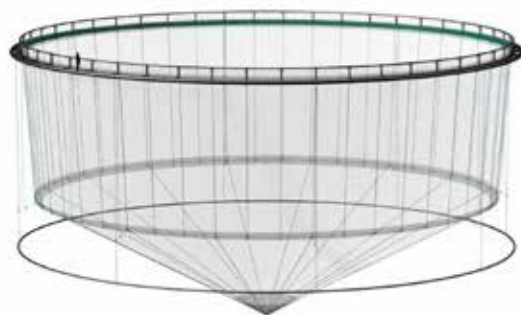

A wide range of strong circular Polarcirkel PE cages are offered in various dimensions.



## Polarcirkel 630

The new, rugged Polarcirkel 630 model has a floating pipe circumference of 630mm and up to 240m cage circumference. Our largest cages are therefore well suited for rough weather conditions along stormy coastlines.

Due to its low weight-to-strength ratio, the Polarcirkel Cages have very high reserve buoyancy compared to cages with other brackets. This easily results in our larger cages having up to 4-6 metric tons higher reserve buoyancy.



The fully integrated anti-skid walkway panels fit securely between the two floating pipes, forming a stable and safe working surface.



All the weight of the net and sinker tube system is supported by the floating pipe - NOT by the handrail.

# A well proven concept in flexible cage design

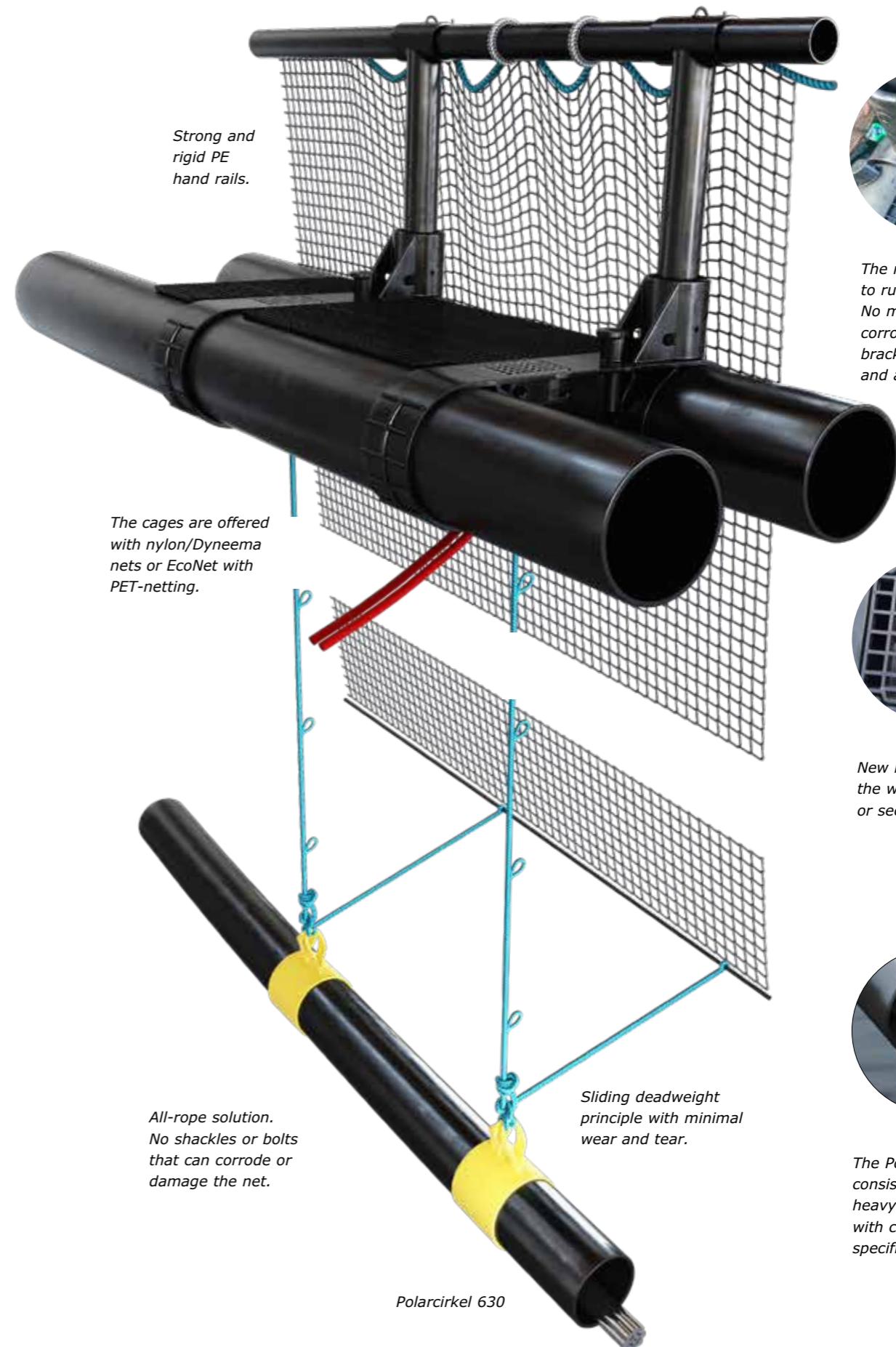

Strong and rigid PE hand rails.

The cages are offered with nylon/Dyneema nets or EcoNet with PET-netting.

All-rope solution. No shackles or bolts that can corrode or damage the net.

Sliding deadweight principle with minimal wear and tear.

Polarcirkel 630



The nets are easily connected to rugged PE plastic brackets. No metal parts that will create corrosion problems. The PE brackets have longer lifespan and are easy to clean.



New recessed connections inside the walkway for bridle, sinkertube or security rope for nets.

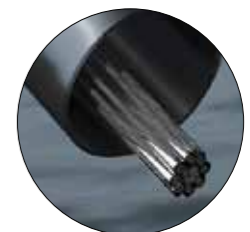

The Polarcirkel Sinker Tube consists of a 200-400mm heavy walled PE pipe filled with chain or wire rope at specified weight.

## Simplified net handling and maintenance

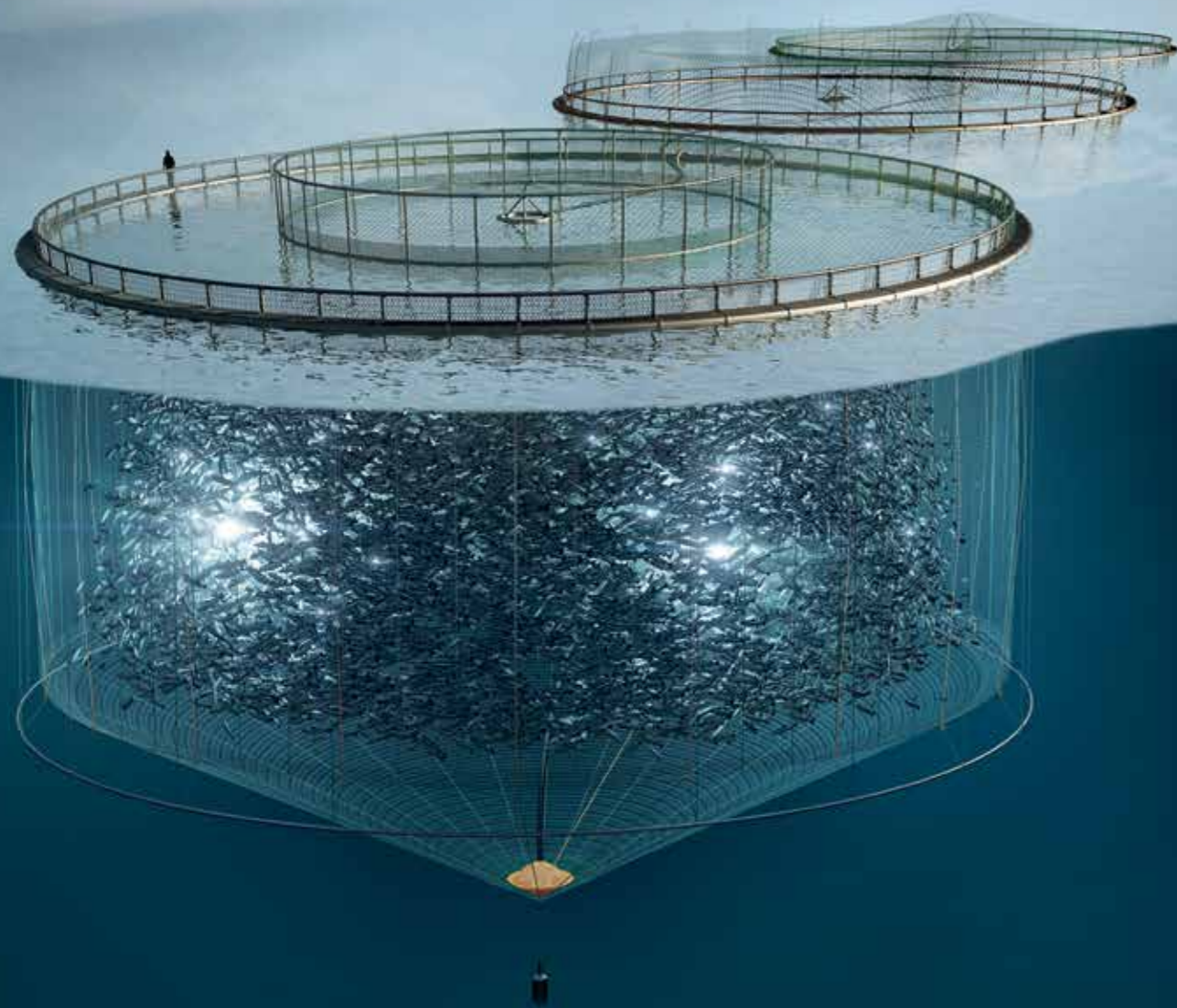

■ A safe and stable platform designed for rough weather conditions.

## The safest and most escape resistant cages on the market

Polarcirkel also offer an optional secondary continuous safety chain inside the outer floating pipe. This will serve as an unbreakable barrier in case the cage integrity is severely compromised. Keeping the chain inside the pipe leaves it out of the water until needed and maintains a clean exterior cage layout. All of this makes the Polarcirkel Cages the safest and most escape proof cages on the market!

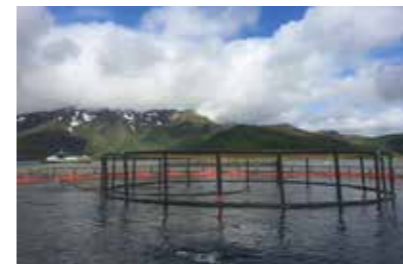

*Polarcirkel 500 with hamster wheel and anti-skid walkway.*



*Various types of net hooks are available. The systems simplify net handling on the cages and provide secure attachment points for your nets.*

### Center Support Stands



*Center Support Stands keeps the bird nets high off the water. Standard sizes from 4m to 5m high. Other heights can also be delivered on request. Hamster Wheels" Center Support Stands can be offered with circumference from 30 up to 72m.*



### Polarcirkel 500

Polarcirkel 500 has a floating pipe diameter of 500mm and up to 200m cage circumference. The cage has been delivered to several large fishfarms along the Norwegian coast line.

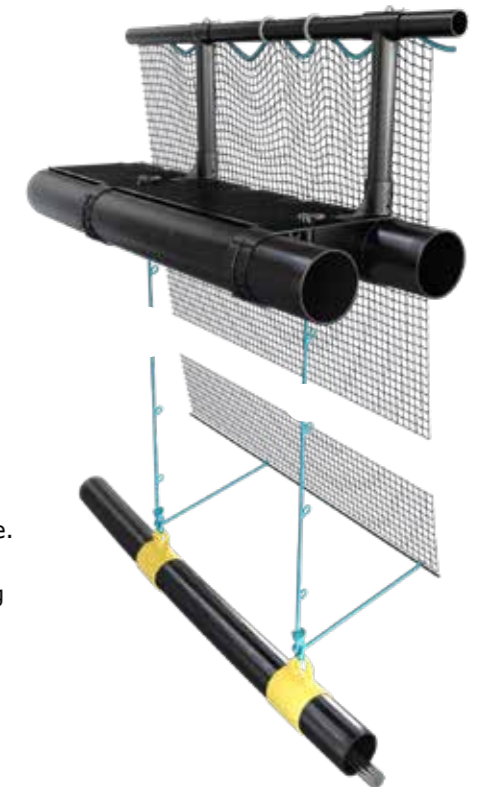

### Polarcirkel 400

Polarcirkel 400 has a floating pipe diameter of 400mm and up to 160m cage circumference. This is one of AKVA group's bestsellers world wide the last decades.

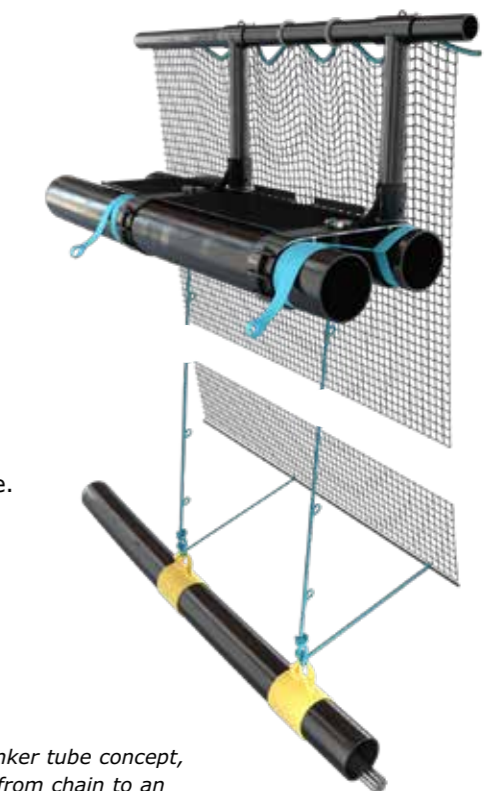

*In terms of our sinker tube concept, this means going from chain to an all-rope solution, including the use of new type of sliding dead weights as an option.*



■ To avoid fish escapes we need to ensure that all potential sources of chafe and net damage are eliminated.

## Plastic Cage Specifications



C A G E S

Cage Models:	225/250	315	400	450	500	630	Comments
Cage sizes – Floating pipe diameter:	225/250mm (9"/10")	315mm (12")	400mm (16")	450mm (18")	500mm (20")	630mm (26")	Imperial sizes to be confirmed.
Cage sizes – Standard circumferences:	40 - 90m (130 - 300')	60 - 100m (200 - 330')	90 - 160m (300 - 530')	120 - 160m (400 - 530')	130 - 200m (430 - 660')	160 - 260m (530 - 860')	At centre of inner floating pipe.
Cage sizes – Standard diameters:	13 - 29m (42 - 94')	19 - 32m (63 - 104')	29 - 51m (94 - 167')	38 - 51m (125 - 167')	41 - 64m (136 - 209')	51 - 83m (167 - 272')	At centre of inner floating pipe.
Center - center distance between floating pipes:	52cm (20")	66cm (26")	85cm (33")	100cm (39")	110cm (43")	140cm (56")	
Bracket – PE Injection Moulded (new PIM Type):	*	Yes	Yes	Yes	Yes	Yes	PIM Bracket (Pressure Injection Moulded Bracket) with plastic uprights.
Connection for bird net support poles:	Yes	Yes	Yes	Yes	Yes	Yes	Available as option.
Standard distance between brackets:	2m (6' 7")	2m (6' 7")	2.5m (8' 2")	2.5m (8' 2")	2.7m (8' 6")	2.7m (8' 6")	Can be customized to fit nets.
Dimension – PE Handrail Upright:	125mm (5")	125mm (5")	160mm (6,5")	160mm (6,5")	160mm (6,5")	200mm (8,1")	
Dimension – Handrail Pipe:	110mm (4,5")	110mm (4,5")	140mm (5,5")	140mm (5,5")	140mm (5,5")	180mm (7,3")	
Net hook on uprights:	PE (SS opt.)	PE (SS opt.)	Stainless Steel (12mm)	Stainless Steel (12mm)	Stainless Steel (12mm)	Stainless Steel (12mm)	One single hook per upright included.
Polystyrene Safety Floatation added:	Only inner pipe	Only inner pipe	Only inner pipe	Only inner pipe	Only inner pipe	Only inner pipe	Custom hooks available
Available with – Secondary Safety Chain (redundancy):	Inside outer pipe	Inside outer pipe	Inside outer pipe	Inside outer pipe	Inside outer pipe	Inside outer pipe	Available in all floating pipes on request.
Materials used – PE80 & PE100:	Yes	Yes	Yes	Yes	Yes	Yes	Continuous internal safety chain inside the outer floating pipe for extra safety
Norwegian Standard – NS9415 Certified:	Yes	Yes	Yes	Yes	Yes	Yes	The Polarcirkel factory is ISO 9001 and ISO 14001 certified.
Available as Two-Ring Cage:	Yes	Yes	Yes	Yes	Yes	Yes	Mandatory for Norway only.
Available as Three-Ring Cage:	Yes	-	-	-	-	-	Standard Cage
Available with Sinkers Tube:	Yes	Yes	Yes	Yes	Yes	Yes	
Avail. with Walkway Decking:	Yes	Yes	Yes	Yes	Yes	Yes	Mainly used for 315 model and up.
Avail. as Submergible Cage:	Yes	Yes	Not yet	Not yet	Not yet	Not yet	Please ask for specific details.

\* Polarcirkel 225/250 are delivered with the original type of the PE injection moulded bracket.

### Polarcirkel quality and certification

All Polarcirkel Cages are manufactured and assembled in accordance with AKVA group's Quality Assurance System (ISO 9001 and ISO 14001) which is certified by DNV (Det Norske Veritas). All cages in Norway are designed in accordance with NS9415 (Norwegian Standard 9415 for cage farming equipment to prevent fish escape).

■ AKVA group delivers complete cage farming solutions worldwide.

# Wavemaster Steel Cages

## Superior design makes an ideal platform for fish farming

Wavemaster is the world's leading brand of steel cages with over to 15.000 cages delivered since 1985! The cages provide an ideal platform for fish farming. Wide non-slip walkways with high free-board around all sides of the cages allow the operator full flexibility of operation and easy access from cage to cage. This is becoming essential for good fish husbandry and maintenance.

The compactness and simplified mooring arrangements make Wavemaster Steel Cages a very attractive option for many sites.

Wavemaster cages are available in a wide range of models, single- or double string systems and sizes up to 40x40m to suit individual needs.

## Patented moulded rubber hinge system reduces loads and increases life-span.



Wavemaster has a proven track record of installations on a wide range of sites and in many different climates around the world, such as here in Iran.



Safe and stable hot dip galvanized cage construction make a safe workplace.



Fully integrated and extra wide non-slip walkways, net supports and floats with self-draining top.

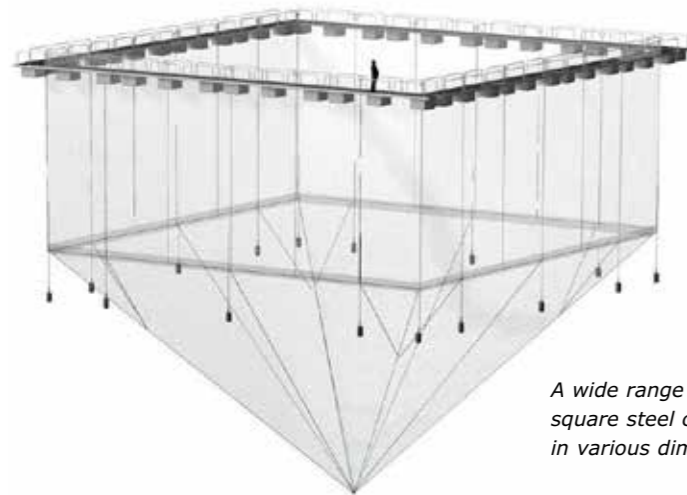

A wide range of high quality square steel cages are offered in various dimensions.

## Ongoing R&D

All of the Wavemaster designs are continuously updated to reflect operating experience and the changing work practises of the fish farmers using the equipment. This continues to make Wavemaster the leading edge steel cage in the fish farming industry.

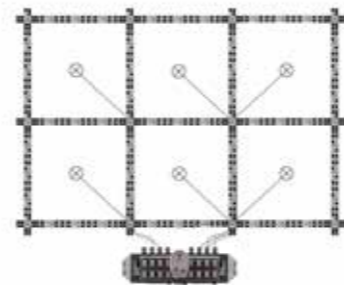

New cage farms are customized for each location with safe and stable non-slip walkways.

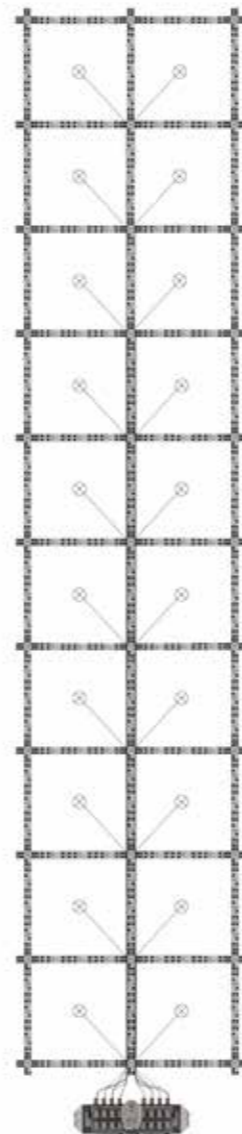

# Safe and strong steel cage solutions

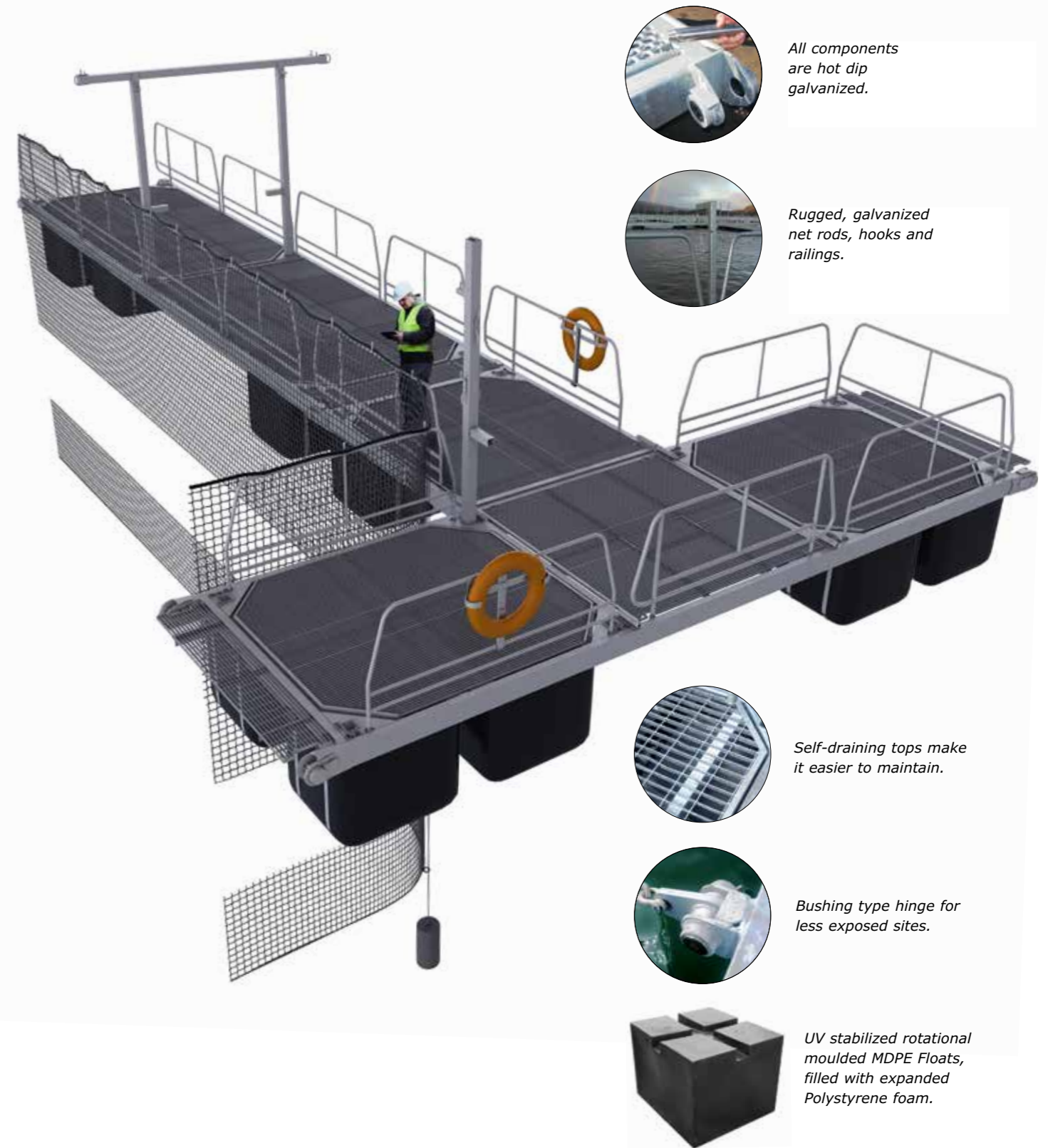

All components are hot dip galvanized.



Rugged, galvanized net rods, hooks and railings.

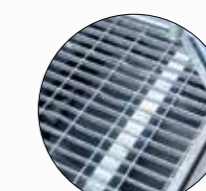

Self-draining tops make it easier to maintain.



Bushing type hinge for less exposed sites.



UV stabilized rotational moulded MDPE Floats, filled with expanded Polystyrene foam.

A trusted and well proven steel cage concept



## Steel Cage Specifications



C A G E S

Wavemaster Cages:	EX-1	EX-2	Comments
Model description:	High Performance	High Exposure	Please consult your Wavemaster representative for expert advice on proper model selection.
Cages sizes available - inner measurements:	10x10m (30'x30') 12x12m (40'x40') 15x15m (50'x50') 20x20m (60'x60') 25x25m (82'x82') 30x30m (100'x100') 40x40m (130'x130')	25x25m (82'x82') 30x30m (100'x100') 40x40m (130'x130')	Others sizes available on request.
Main walkway width:	1.1 - 2.5 m (3'3" - 8'2")	1.1 - 3.0 m (3'3" - 10')	Others sizes available on request.
Perimeter walkway width:	1.1 - 2.5 m (3'3" - 8'2")	1.1 - 2.5 m (3'3" - 8'2")	Others sizes available on request.
Suitable for shipping into 40" containers:	Yes	Yes	On request.
Driveable (Forklift):	No	Yes	On request.
Deck type:	2 or 3mm stamped plate, 32x5 or 38x5 serrated vertical grating	2 or 3mm stamped plate, 32x5 or 38x5 serrated vertical grating	Others design on request.
Main beam sizes:	80x40x5mm up to 200x70x6mm	150x50x5mm up to 200x70x6mm	
Hinge bushing:	35mm (1 3/8") - 45mm (1 3/4")	35mm (1 3/8") - 45mm (1 3/4")	Available in both moulded rubber or nylon type.
Cage configuration layout:	Single or double string	Single or double string	
Floats available - standard:	Yes	Yes	Rotational moulded PE or blowing PE (Colors under request).
Floats available - increased volum:	Yes	Yes	Rotational moulded polyethen (Colors under request).
Floats filled with expanded polystyrene and sealed for added safety:	Yes	Yes	
Ralling height:	1000mm (39,7")	1000mm (39,7")	Others sizes available on request.
Ralling net hooks included:	Yes (Pointed up, down or both)	Yes (Pointed up, down or both)	
Post options for:	Predator net, bird net, Lifting.	Predator net, bird net, Lifting.	On request.
Others accesories:	On request	On request	Please inquire.
Hot dipped galvanizing:	Yes	Yes	



Wavemaster Steel Cages in Chile.

# Safer mooring with low cage point loading

We can offer an innovative mooring connector system that simplifies the mooring process and improves the structural strength of the cage when moored at the site. All anchoring connections and components are NS9415 certified. (Norwegian Standard 9415).

The new Polarcirkel anchoring connector eliminates most of the weak points typical of steel brackets: Corrosion, damage to work boats, sideways jamming of brackets, chafe on floating pipes, need for chafe sleeves, point loading floating pipes, bending connection lugs, icing loads etc.

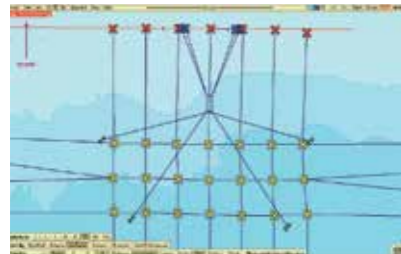

A typical mooring design showing grid, anchors, buoys and barge locations etc. This design allows for for custom positioning to the farm site.



Experienced crew and certified mooring solutions. Anchoring of Polarcirkel cages outside Lofoten in the North of Norway.



The buoys are made of rotation moulded polyethylen filled with polystyrene foam. This retain full floating capasity even if the shell has been damaged.

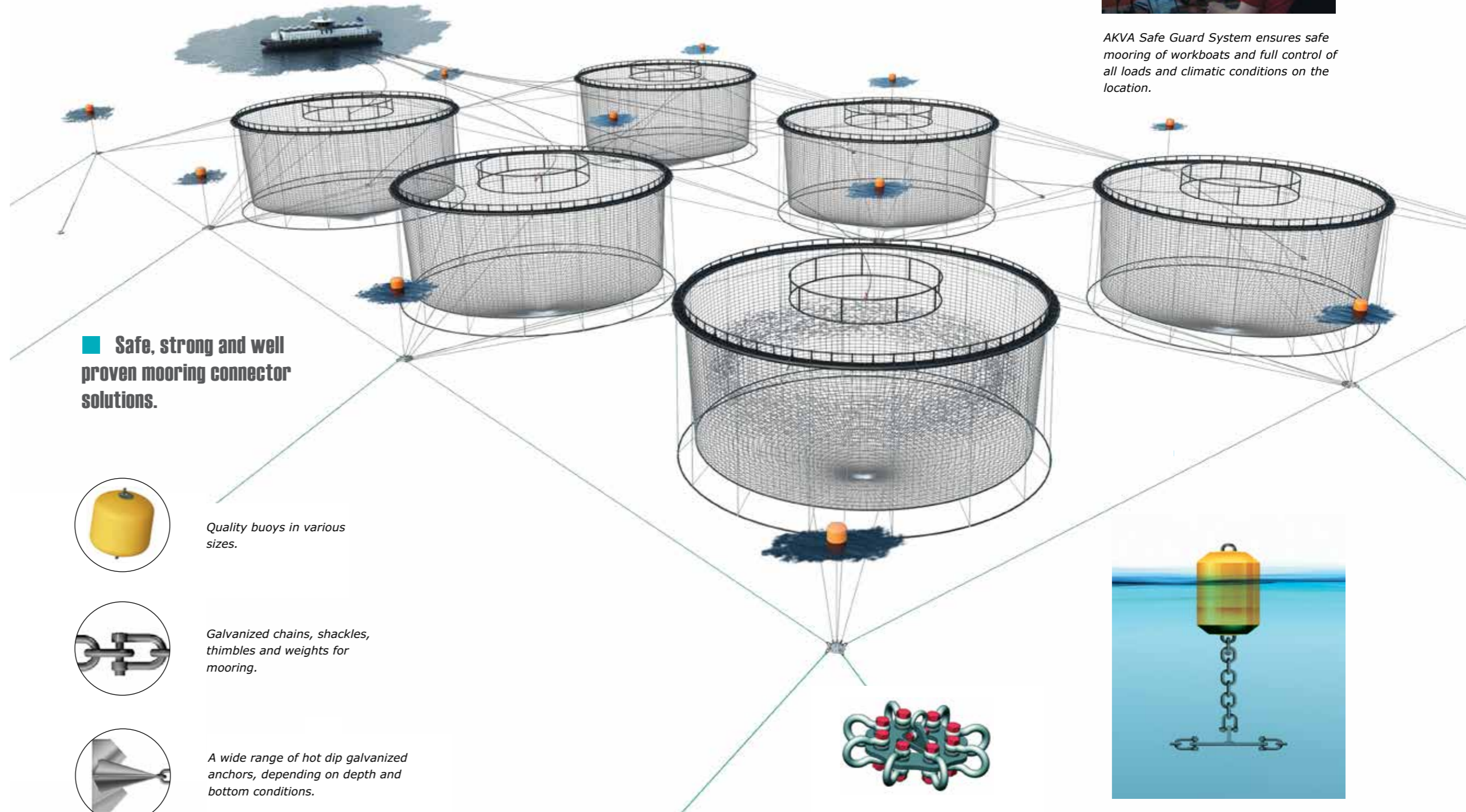

**Safe, strong and well proven mooring connector solutions.**



Quality buoys in various sizes.



Galvanized chains, shackles, thimbles and weights for mooring.

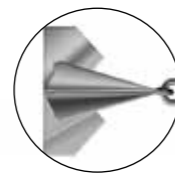

A wide range of hot dip galvanized anchors, depending on depth and bottom conditions.

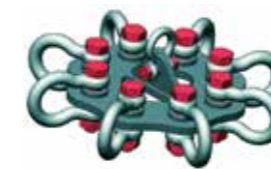

Practical and safe shackle point connection. All steel components used near or under the surface are hot dip galvanized.



All ropes are connected to the mooring plate well below propeller depth, ensure easy boat access around the cages.



AKVA Safe Guard System ensures safe mooring of workboats and full control of all loads and climatic conditions on the location.



## Cage Nets

The highest quality nets safeguard your fish

AKVA group offer several types of nets for your cages. Both traditional and proven fibre nets (mainly nylon) made by Egersund Net in Norway, as well as the innovative and promising non-fiber EcoNets (solid PET wire), made by the Italian company Maccaferri.

As the net is the only barrier keeping your valuable farmed fish inside and predators outside, it is the most critical piece of equipment on a cage farm that prevents fish escapes and other fish losses. Consequently, only the highest quality and design must be used, combined with Norwegian Standard (NS9415) design and dimensioning. In order to ensure correct net specifications for your farm site, documented site environmental loads from currents, waves and wind must be used for dimensioning and design. This must be followed by professional and systematic inspection, maintenance and testing throughout the life span of the net.

The end result is a net you can trust, whether fiber or non-fiber materials.





**Egersund Net is recognized for providing a high level of service.**

## Egersund Net - top of the line for more than 40 years



*These quality nets are based on years of experience with the safety of our customers at heart.*



*A wide range of special design nets are available, including saithe nets, bird nets, harvest nets for both round and square cages.*



*Well proven net constructions for easy handling and low maintenance.*



*Our highly qualified employees have been with us for many years, gathering a great deal of experience, competence and understanding of product characteristics.*

### One of world's leading net and net service suppliers

Egersund Net has developed into one of Europe's leading suppliers of fish farming nets and net services.

### Construction and design

It is very important to ensure the nets are easy and safe to handle. A good user manual as well as clear marking of lifting points facilitate safe and secure handling. The risk of escape is thereby reduced.

The ENCA (Egersund Net Circle Angled) net design is an example of a design which facilitates easier/faster and safer net handling.



*All new models are tested under different current conditions at SINTEF's research tank facility in Hirtshals, Denmark.*

### Netting made in Norway

Egersund Net uses filaments from reputable European suppliers. Long-term cooperation with suppliers ensures the best technical solutions.

We deliver superknot, hexagonal netting, standard knotless netting as well as a variety of knotted netting. Our netting is manufactured of Nylon P6 or Dyneema™ filaments.

Our netting is manufactured with a meshwidth of 1008 meshes, and we are able to produce netting with a breaking strength from 36kg up to 191kg, and up to 220kg in Dyneema™.

### Net testing and research

We are continuously engaged in research and development activities, emphasizing improvement and innovation. We intend to reduce the risk of escapes, reduce the risk of disease, and optimize handling and operation.

Egersund Net invests major resources in product development and testing of models in cooperation with our customers. A test tank allows simulation of various currents and wave conditions.



*Advanced software is used to develop optimum net designs by simulating scenarios.*

### Loops for proper connection of nets and weight system

All connection loops are color coded to ensure that it will be easy for operators to ensure they lift the net using the correct loops and ropes. The loops have been lab tested in Egersund Nets' lab to document the horizontal and vertical forces acting on them.

The loops are fitted in such a way that a failure will not result in net damage. It is also easy to replace worn out loops when the net is serviced.

**The entire net fabrication process is ISO 9001 certified by Det Norske Veritas (DNV) and according to NS9415.**



## Net load calculations - advanced testing



■ All new nets and components are tested and documented under different current conditions.



Net in 0.5 knot current.



Net in 1.0 knot current



Net in 1.5 knot current

## Quality based on experience and product development



The coating helps protect the nets from UV radiation, makes cleaning of the nets easier and increases the life-span of the nets.



The nets are lifted safely during harvesting and cleaning. We also supply sweep nets for all types of cages.



The service package\* includes cleaning of nets, inspection, repair, anti-fouling and abrasion protection.  
\* Some areas only.

### Nylon netting

Special knotless netting made from nylon ensures high quality netting with a long lifespan. Such netting is available in various thread, mesh sizes and colors.

### Dyneema™

Cage nets made of knotless Dyneema™ are stronger and lighter in weight than regular nylon nets. They are often used for species that bites algae off the net and predator protection. Color: White

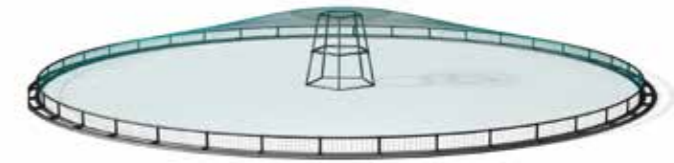

Bird nets with center support.



Bird nets with fiberglass support poles.



Bird nets with "hamster wheel".

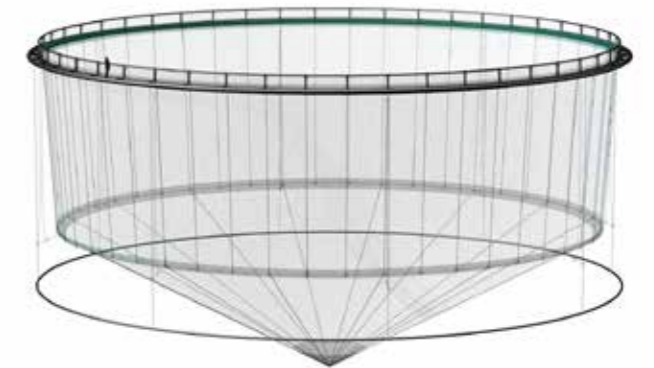

Nets for circular cages with or without sinker-tubes.

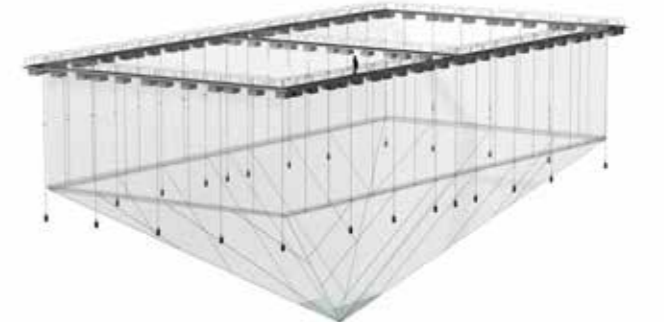

Nets for square and rectangular cages.



Nets for circular angled cages.

## High performance, durability and escape prevention

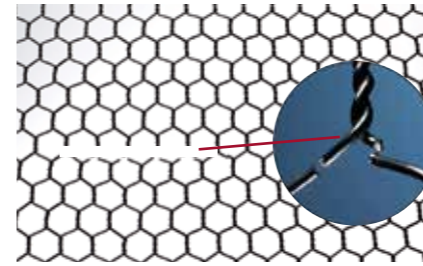

A long cut in an EcoNet will tend to stay closed due to the double twisted thermo formed semi-rigid structure and non-tearing weaving.

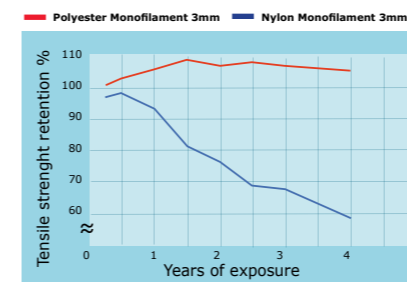

The PET netting wire retains high tensile strength for decades below and above water.



Net sample after 20 years use in seawater in Japan. High tensile strength is retained.



NS9415 certified EcoNets are made in Malaysia by the Italian based Maccaferri Industrial Group.

- High performance and max water flow
- High durability and strength
- Escape and predator prevention
- No need for antifouling paint
- No net changes

EcoNet ensures maximum water flow to the fish. This is due to the very low water drag resistance of the smooth monofilament PET and the semi-rigid structure that retains mesh opening and prevents overall net shape collapse. This has resulted in some of the best ever production results in large scale salmon farming, such as higher SGR, lower FCR, lower mortality and higher fish harvest quality.



EcoNet is used as shark nets as protection outside popular beaches.



The real strength of the EcoNet is well tested when used as rock slide nets!

EcoNet has very high durability, strength and other escape prevention properties. It is certified under NS 9415:2009 to stay in the water for upto 14 years. This eliminates costly net changes and reduce the risk of net damage and fish escape during net handling. The EcoNet is easily cleaned, inspected and maintained while in the water (no anti-fouling used).



EcoNet is handled in very similar ways to a nylon net, including drying up the net for crowding fish during harvest.

### Deformation and loads

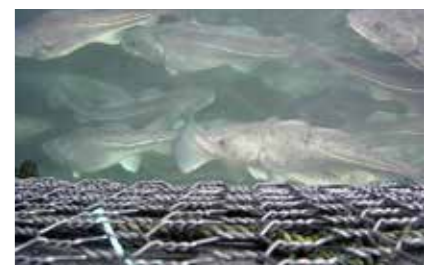

The semi-rigid structure keeps the net shape intact to maximize water flow and oxygen to the fish.

**Polarcirkel EcoNet** has proven very resistant to predator attacks (Grey Seals, Fur Seals, Sharks, Tiger Tooth Fish, Barracuda etc.) due to the strong PET monofilament and semi-rigid and tightly stretched net walls. Should damage to the net occur, the semi-rigid structure has proven to have self-closing properties that prevent fish escape. The mesh are also thermo-formed double twisted to prevent unraveling.



EcoNets are made to withstand rough conditions, stormy weather, predators, biological or mechanical damage.

EcoNet is approved for fishfarming use according to Norwegian Standard 9415 - NS9415, to stay in the water for up to 14 years.



Extreme weather



Predators



Mechanical damage

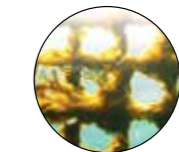

Biological deterioration



# Extra strong long-life EcoNets, easy to install - easy to keep clean



The upper section of the EcoNets have slightly tapered vertical walls with a 1m jump-net up top and the bottom is normally cone shaped.



Polarcirkel EcoNet being installed by use of cranes and skilled farm technicians.



Installation of EcoNet as predator nets in the southern regions of Chile.



For shorter periods, Polarcirkel EcoNet can be hooked onto the railing net hooks when dried up.

Experienced salmon farmers state that EcoNet is easy to operate, handle and clean during ongoing farming operations. The low water drag resistance allows use of light weight sinkertube (10-15 kg/m compared to 40-70 kg/m). This makes handling the net during harvest, grading, sea lice treatments and similar, easier and safer for the farm crew.

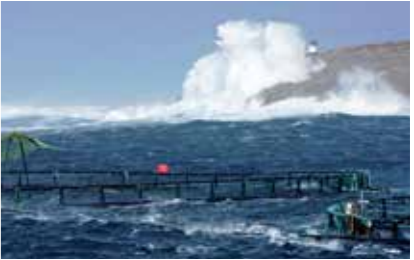

The Polarcirkel EcoNets are made for rough, daily use, from very strong but light weight PET.

### Strong but light material

The shape of the EcoNet wire mesh is designed to remain intact if a single wire is cut. This means the mesh will remain relatively stable and the shape intact with minimum negative effect of the strength of the net cage structure.



The hard non-fibre wire reduce settling of marine fouling and makes the net easy to clean with a net cleaner from AKVA group.

The Polarcirkel EcoNet is made from very strong but light weight PET, (Polyethylene Terephthalate).

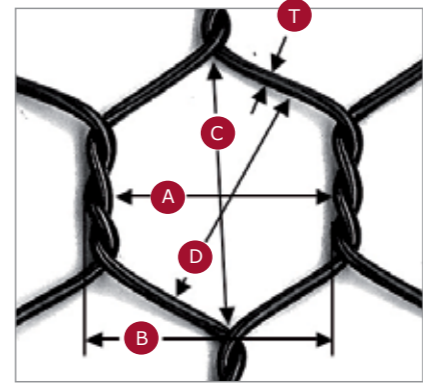

A = Mesh width  
B = Mesh pitch  
C = Mesh height  
D = Mesh diagonal  
T = Wire thickness



If overloaded, EcoNet stretch about 60-70% before it finally breaks.



In comparison, nylon stretch about 40% before it finally breaks.

EcoNet is available in three different mesh sizes. Small is suitable for 150g Atlantic Salmon smolts and up.

Mesh size:	t (mm)	A (mm)	B (mm)	C (mm)	D (mm)	weight
Small:	2,5	35	40	43	37	570g/m <sup>2</sup>
Large:	3,0	45	50	71	59	590g/m <sup>2</sup>
Super large:	3,5	73	80	100	85	450g/m <sup>2</sup>

Note: Super Large is not a fish net and therefore not NS9415 certified.



# A wide range of Net Cleaning Systems

In Net Cleaning, filtered high pressure sea water is used to remove marine fouling on the nets. Idema Net Cleaners use rotating cleaning discs mounted on support frames in various shapes and combinations. We use rugged, tailor-made high-pressure pumps to drive the cleaning discs. The cleaning process starts with submerging the frame on the inside of the net, using only sea water under high pressure. Idema cleaning systems do not use chemicals or scrubbing action making them environmentally friendly while ensuring minimal wear on the nets.

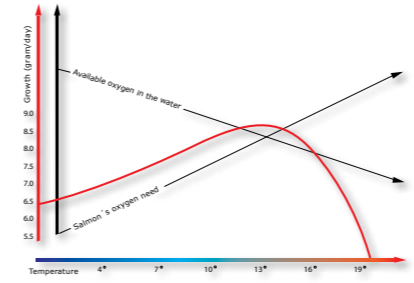

■ Growth  
■ Temperature

**Growth curve for salmon**  
Good waterflow through the nets are crucial at high water temperatures. The growth curve is almost identical for most aquaculture species such as; trout, cod, halibut, sea bass and sea bream.

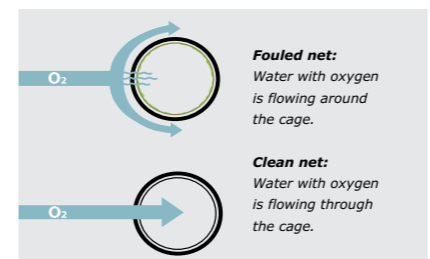

It is proven that increased marine fouling leads to reduced water flow. As a result, the oxygen rich water will mostly flow around the cage.



**Rugged washing rigs with improved features and long lifespan:**

- New washing rig with camera and new water jet thrusters that create significantly better push against the net.
- Stainless shock absorbers reduce vibrations and water pressure hammering in connections and pipes.
- Large integrated particle filter included.
- Can be offered with 1, 2, 5 or 7 cleaning discs.

One of the improved washing rigs, is the 7 disc rig with a stainless steel protective net guard.

On the larger frames we offer tailor-made camera and video systems.



Extra strong 2-layer steel reinforced high pressure hose with strong connector fittings for heavy duty use.

The discs are generally delivered in 40cm diameter.

# Flying Net Cleaner - AKVA FNC8

- safe, powerful and easy to operate

**Flying Net Cleaner can be operated both remotely at the cage and from the control room.**

Flying Net Cleaner is built using standard ROV components that are easy to clean and disinfect. Flying Net Cleaner's ease of use is also assisted by several built-in automated features, sensors that monitor cleaning and advanced camera systems.

The unique feature of the new cleaning rig is that it "swims" along the net line in the pen and cleans using high-pressure seawater. The rig also cleans the top of the net.

- Thrusters for propulsion and pressure (no sharp wheels that can damage the net)
- Robust components and rugged design
- Open construction, easy to maintain
- Advanced control system with touch screen
- Graphic presentation with overlapping images and data

*"It's like driving a Mercedes under water,"*

*Frode Viken, Vikahav (Service company)*



The Net Cleaner can be equipped with a mobile pilot console or alternatively a pilot chair with integrated control system.



The unique feature of the new cleaning rig is that it "swims" along the net line in the pen and cleans using high-pressure seawater. The rig also cleans the top of the net.



Pilot control



Topside control system

Flying Net Cleaner is built using standard ROV components that are easy to clean and disinfect.



High pressure salt water pump



Pilot chair

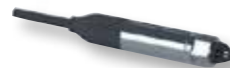

1 x depth sensor



1 x cleaning water pressure sensor



2 color cameras HD wide angle.

Xylan coated frame, AISI 316.

6 thrusters with 2000W.

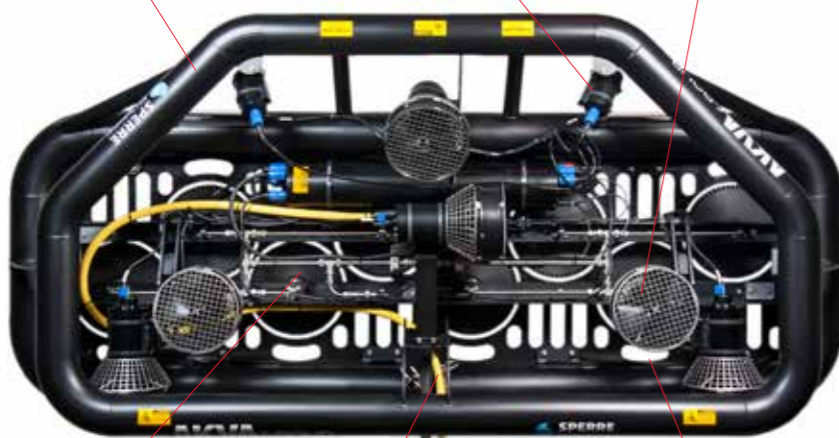

8 cleaning discs in POM.

Fiber tether.

2 LED lights with 15000 lux.

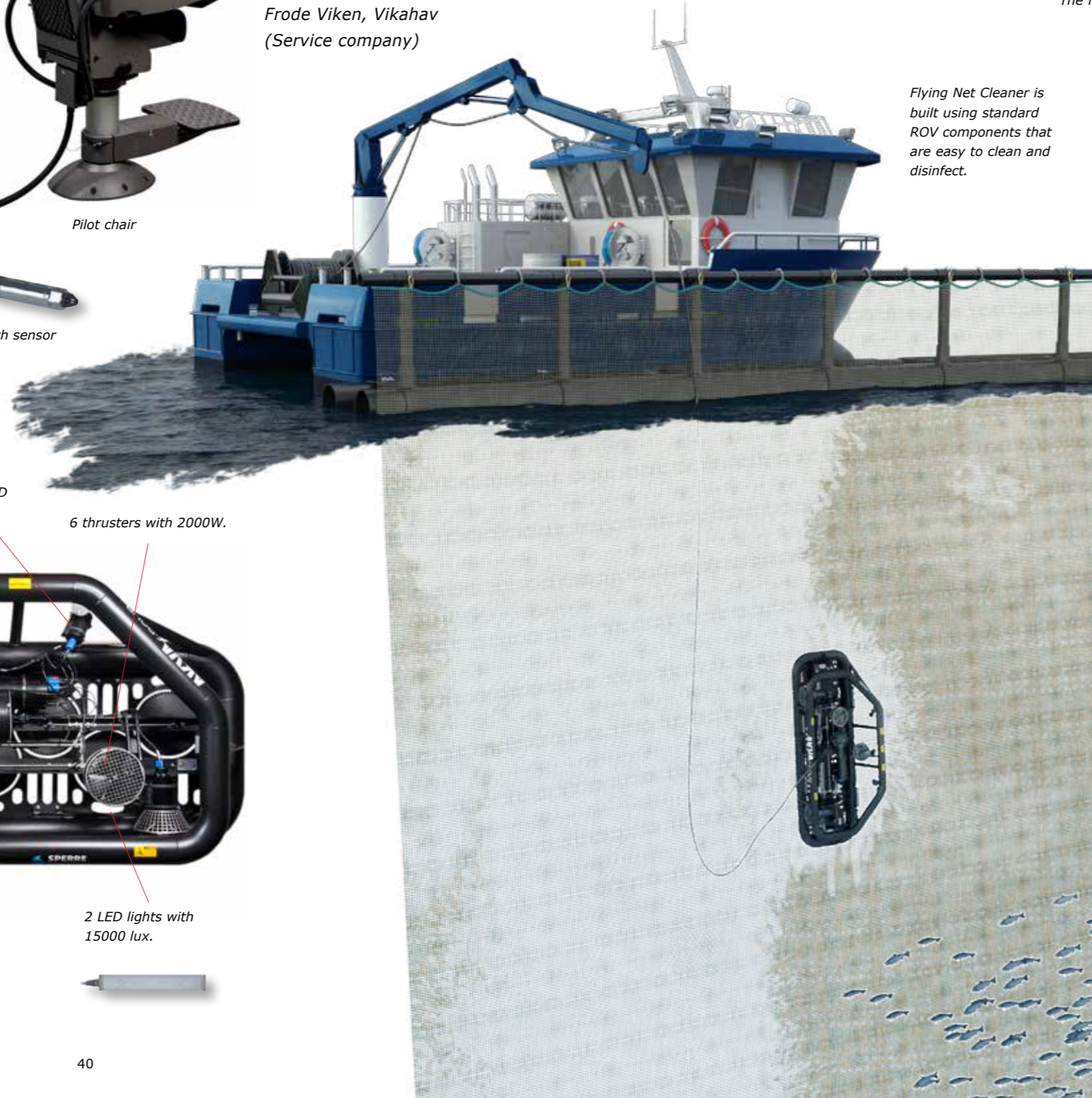

Flying Net Cleaner (FNC8) standard version*	
Physical size of vessel:	LWH 300 x 110 x 66 cm.
Frame construction	AISI 316 and anodised AL6082-T6
Weight on land:	360 kg.
Cleaning area width FNC:	260 cm.
Hourly cleaning capacity:	5,000 m <sup>2</sup> /h (theoretical)
Water consumption/nozzles:	Approx. 340 L/min @ 250 bar (1.2 mm. nozzles)
Nozzle sizes:	1 - 2.0 mm
Feeder hose:	3/4" or 1"
Buoyancy:	Air filled tubing
Power supply (recom. 63Amp):	230V AC - 15 kW, 3 phase 50 - 60 Hz
Thrusters:	6 ea. thrusters 2000W
Speed along net:	0 - 1,5 m/sec
Cameras:	2 HD cameras wide angle, (+ 2 optional)
Transponder connection:	Electricity outlet for navigation transponder
Light interfaces:	2 off
Lights standard:	2 x Sperre LED light 1500lux, (+ 2 optional)
Auto functions:	Auto Depth, Auto Heading
Sensors:	Water pressure cleaning unit, Depth sensor, Moist sensor, electronical, Disc speed sensor (optional)
Communication:	Fiber optical
Cable for FNC, signal & elect.:	Neutral cable for electricity and fibre, std. 100m

Control station	
Operating console:	Option 1, Pilot chair with integrated control system Option 2, Mobile pilot console with control system
Screens for data and video:	2 x computer screen, 2 x video screen
Overlay, data presentation:	Text generator, date, time, depth, sensor value etc.
Video recording:	HD recording, 1 channel, various solutions
Graphical visualization:	Graphical presentation of FNC orientation
Power cabinet:	Main switch, hour counter, fuses, insulation monitoring, V/A meter

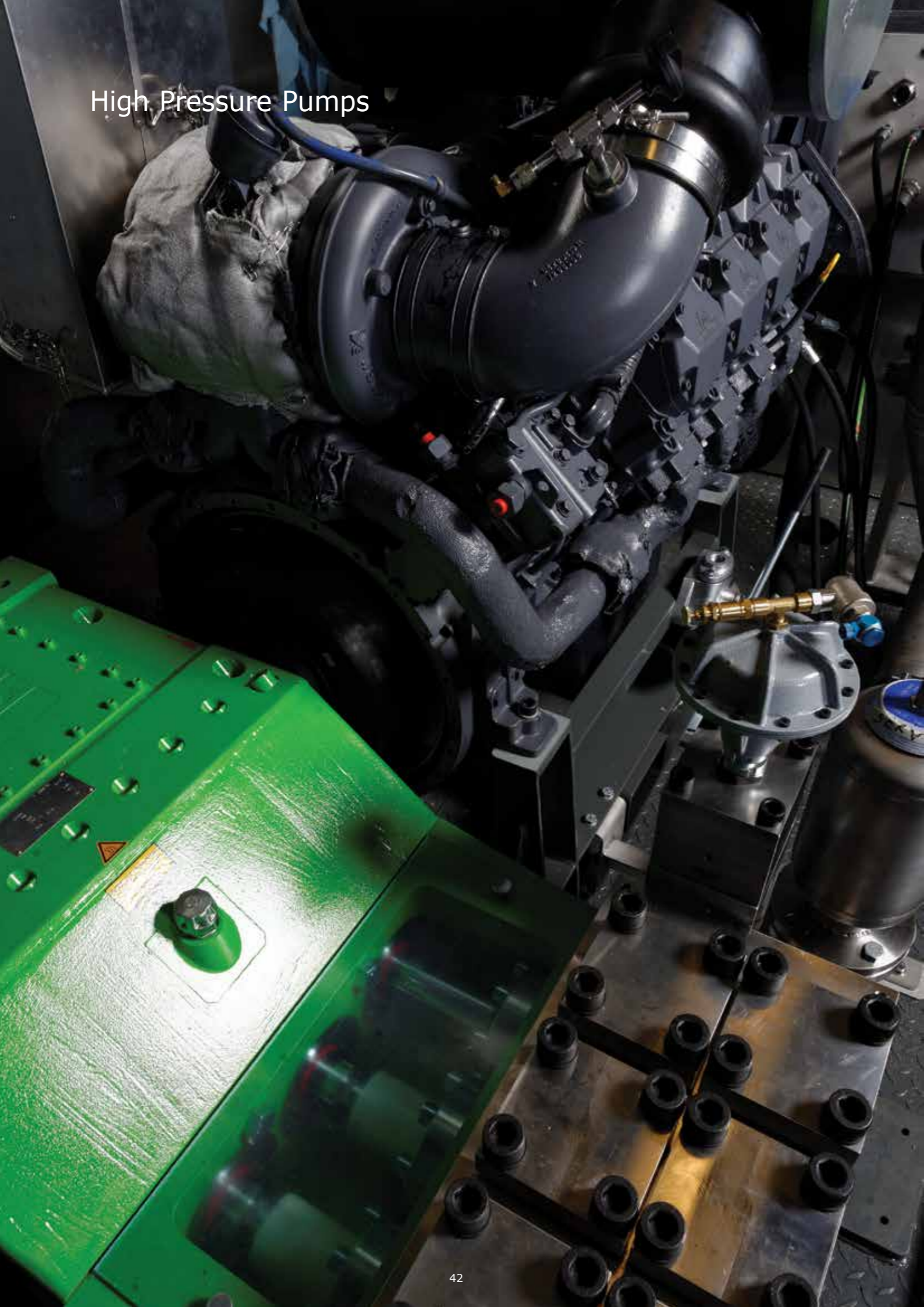

## - Powerful, flexible and reliable



AKVA group offers special designed high pressure pump systems for net cleaning, hull washing and cage cleaning.



The pump systems are delivered with flexible and userfriendly control system that improves both the operation and the safety.



New improved and corrosion free Prattisoli pumps from the interpump group with good service interval and easy of maintenance.



KCC Power System are sole agent of the solid German KAMAT products, who has a good reputation world wide.

**A variety of High pressure pumps are adaptable for all AKVA group systems. We can offer a wide range of user friendly, flexible and reliable high pressure pumps.**

High Flow Pumps – Increased cleaning speed to allow more cages to be cleaned per day.

AKVA group are continually working to develop additional pump system options as well as suitable accessories to enhance the industries requirements & efficiencies. We have a number of integrated as well as standalone options available to support our customers in their Netcleaning Operations:

- **Integrated Hydraulics**
- **External Winch**
- **Wireless Winch Control**
- **Hose Reels**
- **Disinfection Systems**



Simple and robust industrial design built on a common platform with the ability to customize for specific needs.





Working with a variety of recognised engine suppliers John Deere, Deutz Marine and Caterpillar has enabled us to supply an operating system tailored to the requirements of today's emission controls.

AKVA group continually commits themselves to providing a high level of customer support with rapid response times, as well as support to our sister companies globally.

- High pressure pump components and safety valves are delivered in seawater resistant duplex
- Engine and pump monitoring via oil pressure sensors and temperature sensors
- Comprehensive range of spare parts are available from local offices
- Remote control integration options with other systems are available
- Customized solution to suit customer requirements
- Hydraulic winch with folding boom is an available option
- Systems can be packaged in various formats including, offshore container, acoustic canopy or alternatively installed directly into the vessels engine room
- Pump and engine are assembled on a powerful, vibration dampened frame
- Choice of flow rates to suit customer requirements and on site conditions.
- Advanced control system provides more feedback to the operator to give confidence that all is going according to plan
- The system is delivered ready for installation, with the appropriate operation and maintenance manuals.

# Net Cleaning System Specifications



High Pressure Washers*:	D-Drive K-300-240-SD-JD	D-Drive K-240-280-SD-JD	D-Drive K-136-280-SD-JD	D-Drive K-25065-1	D-Drive K-25065-2	D-Drive K-18050-M-5	F-Drive K-28-280-S-D-VA	D-Drive K-28-280-S-D-HZ-22	H-Drive K-28-280-SH	H-Drive K-30-200-SH
Engine:	John Deere Tier 3	John Deere Tier 3	John Deere Tier 3	Catepillar/Deutz**	Catepillar/Deutz**	Catepillar/Deutz**	Vanguard V-Twin	HATZ 2G40	Fitted to workboat	Fitted to workboat
Max hp:	202hp	202hp	156hp	310kw/400hp	315kw/400hp	150kw/200hp	23hp	22hp		
Pump type:	Prattisoli	Prattisoli	Prattisoli	Kamat	Kamat	Kamat				
Size:	300x135x180cm	300x135x180cm	300x135x180cm	304x243x280cm	-	360x240x280cm	120x60x75cm	120x80x80cm	60x35x25cm	60x35x25cm
Weight:	approx. 3000kg	approx. 2900kg	approx. 2750kg	approx. 7500kg	-	approx. 5000kg	80kg	180kg	40kg	40kg
Fuel:	Diesel	Diesel	Diesel	Diesel	Diesel	Diesel	Gasoline	Diesel	Hydraulic	Hydraulic
Max cleaning discs:	10	7	5	10 or 2xFNC8	10 or 2xFNC8	7 or 1xFNC8	2	2	2	2
Recommended cage circumference:	Up to 200 meter	Up to 200 meter	Up to 120 meter	Up to 200 meter	Up to 200 meter	Up to 200 meter	Up to 90 meter	Up to 90 meter	Up to 90 meter	Up to 200 meter
Standard equipment:	Powder Coated or Stainless Steel Acoustic Cabinet, Integrated Centrifugal Suction Pump & High Pressure Pump.	Powder Coated or Stainless Steel Acoustic Cabinet, Integrated Centrifugal Suction Pump & High Pressure Pump.	Powder Coated or Stainless Steel Acoustic Cabinet, Integrated Centrifugal Suction Pump & High Pressure Pump.	Powder Coated Cabinet, 100m high pressure hose, boost pump 230-400V.	Integrated in an engine room. 100m high pressure hose, boost pump 230-400V, power nozzle.	Power Coated Cabinet, 100m high pressure hose, boost pump 230-400V.	40m high pressure hose, 3m suction hose, power nozzle with 40cm extension and swivel.	Stainless steel frame in Euro pallet size with lifting lugs.	Integrated pump	Integrated pump
Water, liter/min:	300	240	136	530	530	309	28	28	28	30
Bar:	240	280	280	240	240	225	280	280	280	200
 • 300 cm	<b>AKVA FNC8 Net Cleaner with remote control.</b>	Recommended for FNC8.	Recommended for FNC8.	-	Recommended for 2 x FNC8.	Recommended for 2 x FNC8.	Recommended for FNC8.	-	-	-
 • 270 cm*	<b>7 disc washing rig in stainless steel.</b>	Recommended for 7 disc rig.	Recommended for 7 disc rig.	-	Recommended for 7 disc rig.	Recommended for 7 disc rig.	-	-	-	-
 • 180 cm	<b>5 disc washing rig in stainless steel.</b>	-	Recommended for 5 disc rig.	Recommended for 5 disc rig.	Recommended for 5 disc rig.	Recommended for 5 disc rig.	-	-	-	-
 • 90 cm	<b>2 disc washing rig in stainless steel.</b>	-	-	-	-	-	Recommended for 2 discs.	Recommended for 2 discs.	Recommended for 2 discs.	Recommended for 2 discs.
 • 30 cm (Shaft model)	<b>Single washing rig in stainless steel.</b>	-	-	-	-	-	Recommended for single disc.	Recommended for single disc.	Recommended for single disc.	Recommended for single disc.

\* The traditional cleaner disks we use have a user range from 15 – 40 liter per minute (lpm) of water for each disc. The nozzle dimension (diameter) will give the recommended pressure, which shall not override 300 Bar.

\*\* Alternative engine solutions. (For more details contact our sales offices).



# Workboats

## Designed for extreme conditions

The robust workboats offers great design, quality build, unique flexibility, user-friendliness and low maintenance. More than 2000 boats are in use in fish farming, marine industry, gas/oil industry, emergency services, military, arctic tour operators and pleasure boaters who need an indestructible boat.

All AKVA group boats are tested in extreme weather conditions all over the world. All models are loaded with smart details and unique features for safe operation in tough conditions and we ensure our products have an emphasis on safety and the environment.





These robust Open Workboats offers great design, quality build, unique flexibility, user-friendliness and low maintenance. Polarcirkel RBBs (Rigid Buoyancy Boats) are self-bailing, in contrast to a conventional RIB, and have rigid pontoons filled with polystyrene. Combined with 21° V-shaped hull, this design makes a virtually unsinkable boat with unique stability and excellent seaworthiness.



We offer Polarcirkel Open workboats with outboards in sizes from 5,80 up to 8,45 meters. The inboard series ranges from 6,85 to 8,45 meters.

All Polarcirkel boats are tested in extreme conditions all over the world. They are loaded with smart details and unique features for safe operation in tough conditions, with emphasis on safety and the environment. The PE-100 plastic is LNG-based with great recycling properties.

The 685, 785 and 845 models are offered with new hull design, which gives better lift, and forces the spray out to the sides. These improvements provides better seaworthiness and and a more comfortable ride.



Polarcirkel has flexible model solutions, such as Polarcirkel Sport, with removable cockpit canvas for windy or rainy days.

### Open Workboats, standard equipment:

- 4 pcs mooring cleats
  - Extra protective hull strips
  - Stowage space with hatch
  - Manual bilge pump
  - Self-bailing deck
  - Red gunwales
  - Fire extinguisher
  - Non-skid rubber deck mat outside
  - Red PE rub rail on pontoons
  - Built-in steps in aft pontoons
  - Hydraulic steering wheel
  - CE approved, category C
  - RPM gauge, temperature gauge, oil pressure gauge, voltmeter and tilt indicator
  - Steering console with instrumentation and antenna arch with nav-lights
- Outboard only:**
- 4 x lifting eyes
  - Step boards
  - Fuel tank: 103L (560) or 210L (685, 785 and 845)
  - Fuel gauge
  - Battery compartment under bench
  - Guard rails around bench
  - Seat with stowage space
- Optional equipment:**
- Search lights, work lights, antenna arch, bow platform with pulpits, marine electronics, etc.

Open Workboats	580	685	785	845
Lenght (LOA):	580cm (19')	685cm (21' 8")	785cm (25'8)	845cm (27'7")
Beam (BOA):	207cm (6' 9")	248cm (8' 2")	271cm (8' 10")	271cm (8' 10")
Displacement:	750kg/1650 lbs	950kg/2090 lbs	1250kg/2750 lbs	1375kg/3025 lbs
Max HP:	115HP	250HP	300HP	350HP
Recommended HP:	From 60HP	From 100HP	From 115HP	From 150HP
Max load:	1000kg/2200 lbs	1250kg/2760 lbs	2250kg/4960 lbs	2250kg/4960 lbs
Max persons:	10	10	12	12
Shaft:	Long	X-Long	X-Long	X-Long/Ultra long
V-bottom :	21°	21°	21°	21°
Inboard engine:	Not available	Available	Available	Available
Water Jet:	Not available	Not available	Available	Available

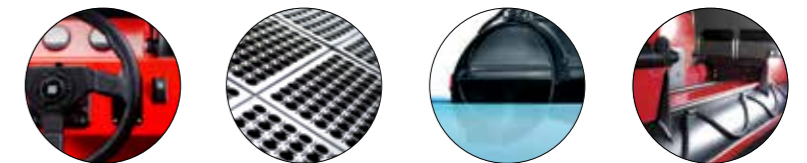

Hydraulic steering wheel, self-bailing deck, sloping pontoons with integrated steps and smart options like hinged gunwale.



We deliver tailor made workboats for professional users such as, fish farming, coast guard, navy, fire department, police, tour operators etc.



The boats have performed exceptionally well in arctic and tropical regions and can handle temperatures from -40°C to +55°C.

**■ New bow and hull design provides better seaworthiness and less sea spray.**



AKVA group's tough and reliable hand-crafted Polarcirkel Cabin Workboats benefit from great design values, high quality build, unique flexibility and extremely low maintenance. Polarcirkel RBBs (Rigid Buoyancy Boats) are self-bailing, in contrast to a conventional RIB (Rigid Inflatable Boat), have rigid pontoons filled with polystyrene for ultimate safety.



*Polarcirkel Cabin Workboat can also be delivered in a popular outboard version. A smart solution with large deck space.*

### New hull design

The Polarcirkel Cabin 785 and 845 models have a new and improved bow design. The bow is raised with 25cm. The bow has been raised 25cm to improve ride comfort and reduce spray.



*Polarcirkel Cabin can be used in various applications. The photo above shows a fire service boat with fire pump and fire fighting equipment.*

### Cabin Workboats, standard equipment:

- 4 pcs mooring cleats
- Extra protective hull strips
- Stowage space with hatch in bow
- Manual bilge pump
- Self-bailing deck
- Red gunwales
- Fire extinguisher
- Hydraulic steering wheel
- Dashboard mounted controls
- Electric bilge pump with sensor
- Insulated engine hatch with pneumatic lifters
- Battery, main switch & ignition lock
- Insulated cabin
- 3-passenger bench seat
- RPM gauge, temperature gauge, oil pressure gauge, voltmeter and tilt indicator
- Built-in diesel tanks 2 x 220 litres
- Head available on the 910 model

- Non-skid rubber deck mat outside
- Red PE rub rail on pontoons
- Built-in steps in aft pontoons
- CE approved, category C

### Optional equipment:

Search lights, work lights, hydraulic installation, capstan, bow platform with pulpits, marine electronics, etc.



*New bow and hull design.*



*Volvo Penta inboard turbo-diesels from 130hp to 435hp and hydraulic steering wheel. Useful options like hydraulic winch and search lights.*

Cabin Workboats, inboard	785	845	910
Length (LOA):	785cm (25,8')	845cm (27,7')	910cm (30")
Beam (BOA):	270cm (9')	270cm (9')	300cm (10')
Displacement:	2400kg/5290 lbs	2600kg/5730 lbs	3600kg/7940 lbs
Max Hp:	260hp	310hp	435hp
Recommended HPS:	From 225hp	From 225hp	From 370hp
Max load:	1600kg/3530 lbs	1400kg/3090 lbs	1400kg/3090 lbs
Max persons:	5	5	5
Material, Polyethen:	12mm	12mm	15mm
Shaft (Outboard versions):	X-long	X-long	—
V-bottom 21° :	•	•	•



*The models have a comfortable cabin and can be equipped with cage control monitors and advanced software.*



*Polarcirkel RBB hulls are self-bailing and have rigid pontoons filled with polystyrene that makes them virtually unsinkable.*

# Polarcirkel 1050 Workboats



## - with double sloping pontoons

### A smart work boat concept

AKVA group has developed a boat based on an entirely new concept. The boat has double buoyancy pontoons manufactured from 500mm PE tubing. The hull is approximately identical to our other boats, featuring a 21° V-bottom, however, this model has 3 pressure-tested chambers. This ensures very good buoyancy.



*Polarcirkel 1050 model is a tailor made workplace with many practical solutions and smart details.*

The Polarcirkel 1050 model can be offered with an inboard motor with drive propulsion, inboard motor with water jet, or ordinary outboard motors. The cabin boat can also be delivered with twin motors.

A prototype has been equipped with two 265 hp motors, and the boat has a maximum speed of around 40 knots. Window wipers are installed for all front windows. A number of useful details are included, such as stainless steels shackles, lots of cabin space, slanted stern tube with incorporated steps and comfortable padded seats.



*Polarcirkel 1050 can also be offered with other engine alternatives, here's a new version with two outboard motors.*

### Polarcirkel 1050 standard equipment:

#### Engine: Inboard engines with water jet, inboards with stern drive, or outboard engines.

- Bow propeller 6hp, continuously variable
- Manual bilge pump
- Electric bilge pump with sensor
- Self-bailing deck
- Hydraulic steering with servo assisted steering wheel
- Motor installation includes battery, cabling, main power switch
- Built-in fuel tanks, 630 litres
- Built-in steps in aft pontoons
- Pulpits
- Insulated motor hatch with pneumatic lifters
- Stowage space in bow
- Step mouldings
- Automatic fire extinguisher in engine room
- 6 heavy duty cleats

#### Cabin Equipment

- Material: aluminium, WXL = 1,9mx4,2m or 1,9mx3,2m
- Windows, sliding windows for captain and helmsman
- Ladder to roof (mounted on rear side)

- Adjustable pilot seat, for the rest of the seats it can be choosed between chairs and benches with lockers.
- LED mlights in ceiling
- Exit on rear side. (Libra door)
- Mast with lanterns on roof
- Dashboard with motor control instruments, navigation equipment, etc.
- 2 cupholders
- Control handles mounted on dashboard
- Two 12V sockets in dashboard
- Fire extinguisher
- Large stowage space under forward pulpit (A toilet can be installed here)
- Defroster 10 KW
- Railing along roof and walls
- Compass

**Options:** Chart plotter, radar, AIS, VHF, hydraulics, capstan, lifting crane, pantry, toilet, refrigerator.

Polarcirkel 1050	
Length (LOA):	1050cm (32')
Beam (BOA)	350cm (11')
Displacement:	5.700kg
Max speed:	40 knots
Max persons:	Depending of model
V-bottom :	21°
Material, hull:	PE 100
Cabin:	Aluminum 1,9x4,2m
Pontoons:	Double, 0,5m Ø filled with polystyrene
Construction:	Buttwelded hull with 3 water proof bulkheads



*The Polarcirkel 1050 models have got new spacious cabins with entrance aft and emergency exit at the front.*



*The 1050-series has well arranged dashboard. All antennas, radars o.e. are mounted on the roof and are easy available with an aft ladder. Exterior steering position can also be installed.*



*1050 can also be delivered with a crane solution, an external control position for the helmsman, rescue net, bow thruster, and maritim electronics, such as chart plotters, radars and Thermic cameras.*



*The boat is equipped with a large cabin type walk-around. Inside the cabin, there are four padded seats and a large bench seating three persons.*



## Feed Barges

AKVA group is the world's leading supplier with decades of experience and with close to 300 barges delivered world wide.

The latest models provide true scale of economics efficiencies to a wide range of cage farming operations with sizes ranging from 96 to 850 metric tons. They include the latest innovations in FEED CARE OPTIMIZED and efficient feed handling, storage, logistics and personnel comforts to ensure a functional and safe farm base for your crew.

AKVA group has feed barges suitable for a wide range of sites and climates, including inshore, offshore, arctic and tropical areas. All barges are delivered complete, fully self contained with Akvasmart CCS Feed Systems, generator(s), control room, living quarters, safety equipment and all other optional equipment installed, such as integrated mort silage systems, camera- and sensor systems.



# Wavemaster Feed Barges

Up to 850 tons and 16 parallel feed lines

The main purpose for a feed barge is to provide the most efficient and reliable feed system for your farming operations. The second purpose is to provide a safe and seaworthy barge that can withstand the forces of nature at your farmbase site.

Each individual barge model has been optimized to ensure the lowest possible cost compared to size of barge. As a result, the AKVA group Feed Barges are the most cost efficient barges on the market with no material or space wasted.



**Full overview and control**  
The control room is the heart of the feed barge. This is where the operator has all the information available and controls the entire feeding process.



**Just like home**  
Modern feed barges today are becoming a main work place with proper facilities, living areas and entertainment centers.



**Sound proof machine room**  
A big machine room with sound proofing makes the maintenance easier, and leaves room for more equipment.

**Flexible crane solutions**  
Cranes of high quality and different sizes can easily be installed on the barges.

**Tailormade quality barges for a wide range of sites and climates.**

**Automatic silo hatches**  
They will open safely and easily with a new electrical remote system. New silo loading system means only 4 hatches are opened to load 16 silos, thereby shortening loading time.

**Large silo capacity**  
The feed storage capacity in each silo range from 15-84 metric tons (based on a density of salmon feed at 650kg/m<sup>3</sup>).

**Larger deck space?**  
Our new AB 450 and 650 barges are designed with larger deck space and more working area.

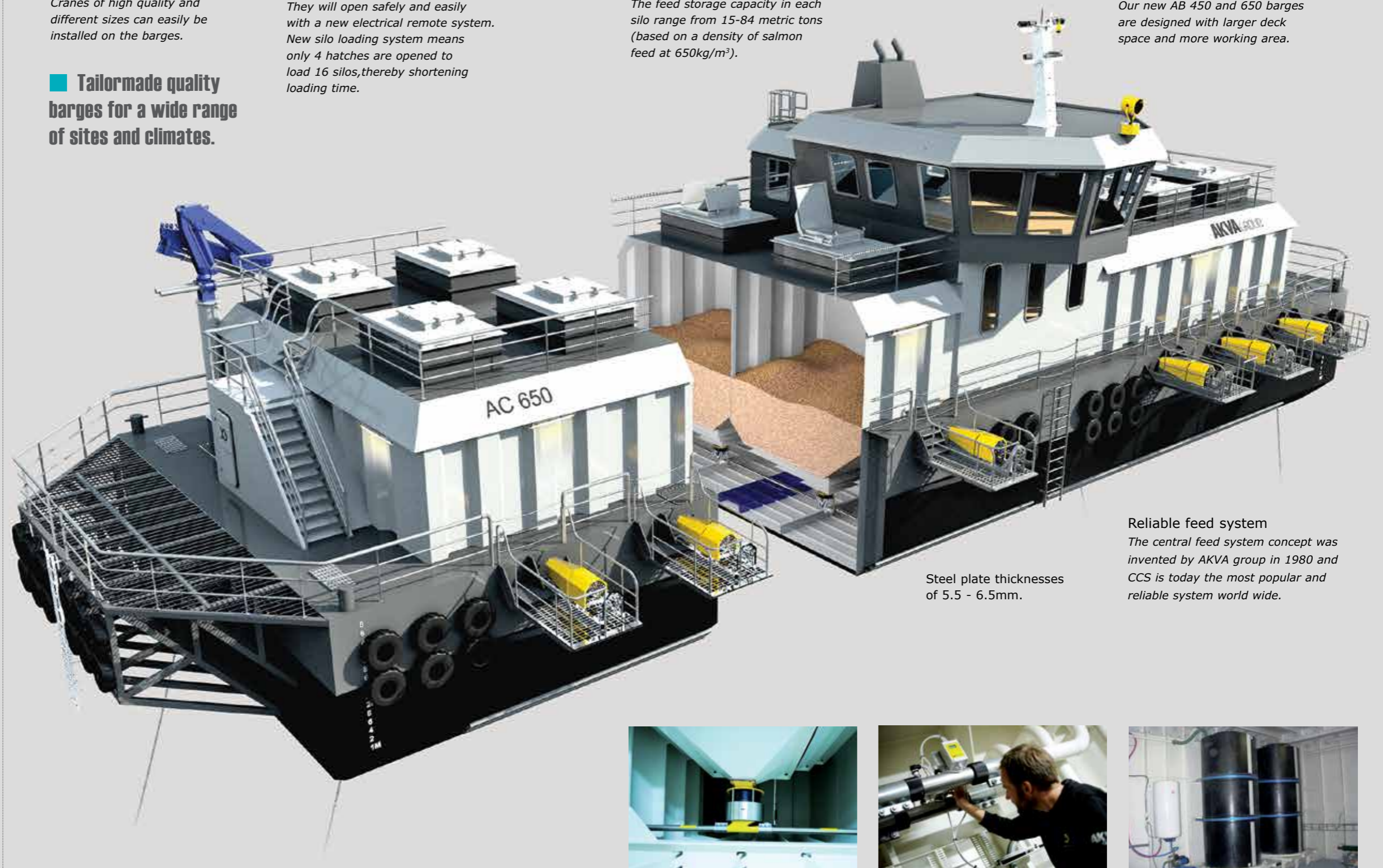

Steel plate thicknesses of 5.5 - 6.5mm.

**Reliable feed system**  
The central feed system concept was invented by AKVA group in 1980 and CCS is today the most popular and reliable system world wide.

**"Trumpet" mooring pipes**  
Reinforced bottom "trumpet" mooring pipes distributes loads and prevents chain being snagged during tightening.

**Watertight bulkheads**  
Subject to local safety regulations, most barges include 3-5 watertight bulkheads with two automatic bilgepumps in each.

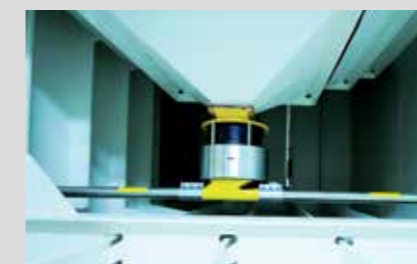

**Gentle feed handling**  
Custom designed feed doser valves transfer the feed into the air flow. Air control ensures gentle feed handling.



**Optimal Air Control**  
Air control system allows for real time measurement of airflow, back-pressure and temperature ensuring optimum feed handling.



**Integrated tanks**  
Most barges are supplied with large fuel tank(s), freshwater tank, hot water tank, sewer tank and optional integrated mort silage tank(s).

# AB 650/450 Comfort/ Panorama



AB 450 Comfort

# AC 850/650 Comfort/ Panorama



AC 850 Panorama

## AB 650/450 features

- Feeding capacity Hexa System - 6 to 8 silos, 75 ton each
- Big storage room under main deck up to 100 m<sup>2</sup>
- Working area on main deck up to 80m<sup>2</sup>
- Spacious engine room prepared for the advanced power management system
- Dimensioned to withstand up to 4m significant wave height (Hs).
- Design & comfort are key interior features.
- Great stability features.
- Large crane capacity located on the mid barge.
- Metallized above waterline to ensure high quality corrosion protection.
- 2 years paint warranty
- Integrated tank system with large capacity.



Silo deck level

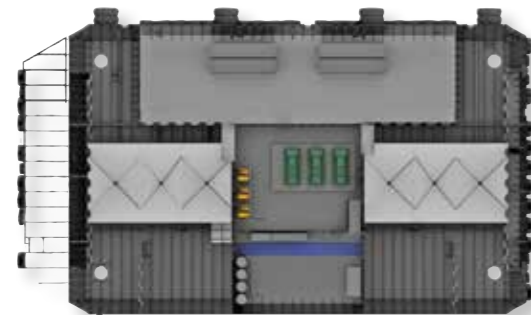

Main deck level

Capacity	AB 650	AB 450
Feed storage capacity:	650 tons (8 silos*)	450 tons (6 silos)
Silage:	Up to 90 tons	Up to 60 tons
Fuel Oil:	Up to 30 tons	Up to 36 tons
Fresh water:	Up to 10m <sup>3</sup>	Up to 6m <sup>3</sup>
Sewage:	Up to 10m <sup>3</sup>	Up to 5m <sup>3</sup>
<b>Main Dimensions</b>		
Length (ex. platforms):	30m	30m
Beam:	19m	19m
Hull height:	3,6m	3,3m
Minimum freeboard:	1,210m	1,210m

\* AB 650 are offered with 8 silos alt. 4 silo hatches.

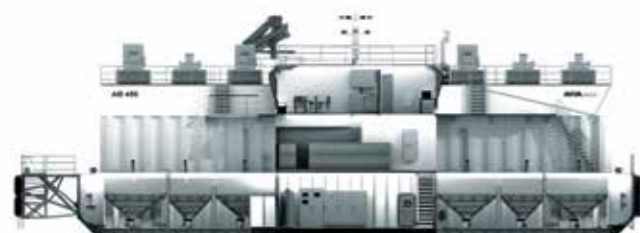

Control room and living room  
Cabin level  
Deck level Storage/ Workshop



Gallery  
Wardrobe  
Machine room

## AC 850/650 features

- Feeding capacity up to 4 x Quattro System (12-16 silos).
- Dimensioned to withstand up to 4m significant wave height (Hs).
- Design & comfort are key interior features.
- Panorama provides the view control of the silos and the cages.
- Suitable accomodation perfect for long stays onboard.
- Spacious engine room prepared for the advanced power management system.
- Metallized above waterline to ensure high quality corrosion protection.
- 2 years paint warranty.
- Integrated tank system with large capacity.

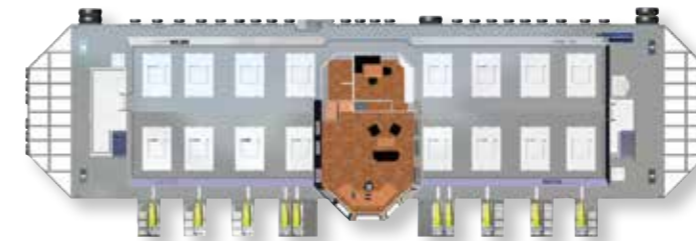

Control room and silo deck level

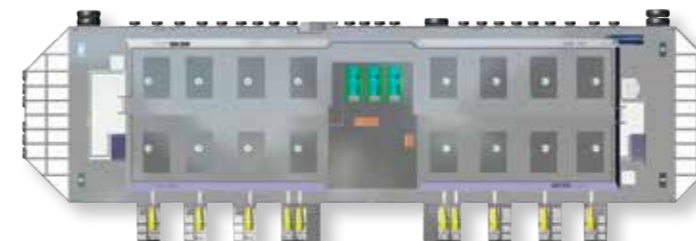

Main deck level

Capacity	AC 850	AC 650
Feed storage capacity:	850 tons (16 silos)	650 tons (12 silos)
Silage:	Up to 60 tons	Up to 60 tons
Fuel Oil:	Up to 24 tons	Up to 24 tons
Fresh water:	Up to 8m <sup>3</sup>	Up to 8m <sup>3</sup>
Sewage:	Up to 3m <sup>3</sup>	Up to 3m <sup>3</sup>
<b>Main Dimensions</b>		
Length (ex. platforms):	44,6m	31,3m
Beam:	12m	12m
Hull height:	4,0m	4,0m
Minimum freeboard:	1,391m	1,233m



Control room and living room  
Cabin level  
Deck level Storage/ Workshop

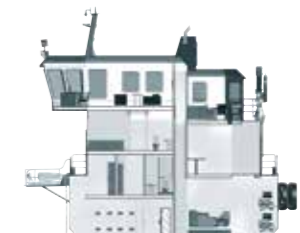

Wardrobe  
Machine room

# AC 600 PVDB



# AC 600 PV



## AC 600 PVDB (Panorama V-bottom, Double Bow)

- Feeding capacity up to 3 x Quattro System (12 x lines) 2 big silo hatches.
- Dimensioned to withstand up to 6m significant wave height (Hs).
- Design & comfort are key interior features.
- Panorama provides the view control of the silos and the cages.
- Suitable accomodation perfect for long stays onboard.
- Spacious engine room prepared for the advanced power management system.
- Metallized above waterline to ensure high quality corrosion protection.
- 2 years paint warranty.
- Integrated tank system with large capacity.



Control room and silo deck level



Main deck level

Capacity	AC 600 PVDB
Feed storage capacity:	600 tons (8 silos) 2 big hatches
Silage:	Up to 77 tons
Fuel Oil:	Up to 25 tons
Fresh water:	Up to 8m <sup>3</sup>
Sewage:	Up to 5m <sup>3</sup>
<b>Main Dimensions</b>	
Length (ex. platforms):	43,4m
Beam:	12m
Hull height:	5,2m
Minimum freeboard:	1,44m

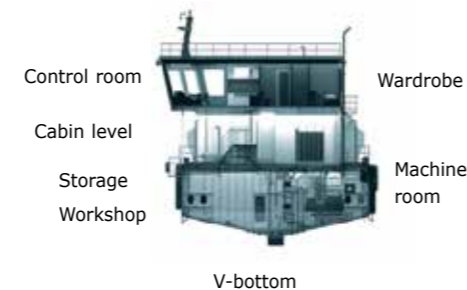

## AC 600 PV (Panorama V-bottom)

- Feeding capacity up to 3 x Quattro System (12 x lines) 4 big silo hatches.
- Dimensioned to withstand up to 5m significant wave height (Hs).
- Design & comfort are key interior features.
- Panorama provides the view control of the silos and the cages.
- Suitable accomodation perfect for long stays onboard.
- Spacious engine room prepared for the advanced power management system.
- Metallized above waterline to ensure high quality corrosion protection.
- 2 years paint warranty.
- Integrated tank system with large capacity.



Control room and silo deck level

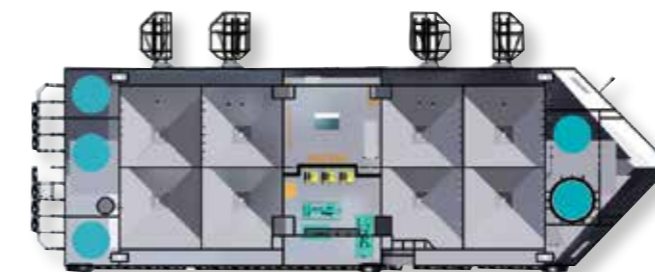

Main deck level

Capacity	AC 600 PV
Feed storage capacity:	600 tons (8 silos) 4 big hatches
Silage:	Up to 75 tons
Fuel Oil:	Up to 30 tons
Fresh water:	Up to 8m <sup>3</sup>
Sewage:	Up to 5m <sup>3</sup>
<b>Main Dimensions</b>	
Length (ex. platforms):	39,2m
Beam:	12m
Hull height:	5,2m
Minimum freeboard:	1,33m

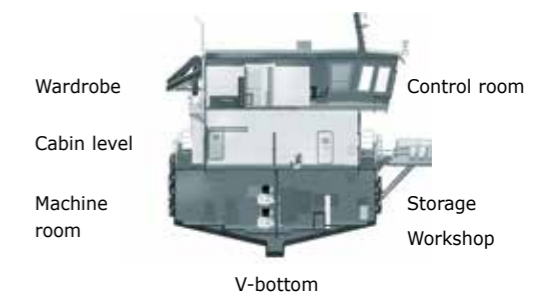

# AC 450/350 Comfort/ Panorama



AC 450 Panorama

# AM 400/320/240 Classic/Comfort



AM 320 Comfort



Control room and silo deck level



Living quarters, wardrobes, silos

## AC 450/350 features

- Feeding capacity up to 2 x Quattro System (8 x lines).
- Dimensioned to withstand up to 3,5m significant wave height (Hs).
- Design & comfort are key interior features.
- Panorama provides the view of the silos and the cages.
- Suitable accommodation perfect for long stays onboard.
- Spacious engine room prepared for the advanced power management system.
- Metallized above waterline to ensure high quality corrosion protection..
- 2 years paint warranty.
- Integrated tank system with large capacity.

Capacity	AC 450	AC 350
Feed storage capacity:	450 tons (8 silos)	350 tons (8 silos)
Silage:	Up to 50 tons	Up to 40 tons
Fuel Oil:	Up to 30 tons	Up to 30 tons
Fresh water:	Up to 6m <sup>3</sup>	Up to 8m <sup>3</sup>
Sewage:	Up to 5m <sup>3</sup>	Up to 5m <sup>3</sup>
<b>Main Dimensions</b>		
Length (ex. platforms):	22m	28,4m
Beam:	12m	10m
Hull height:	4,0m	3,5m
Minimum freeboard:	1,074m	1,182m



Control room and living room  
Cabin level  
Deck level Storage/ Workshop



Gallery  
Wardrobe  
Machine room



Control room and silo deck level



Machine room, silos aft deck

## AM 400\*/320/240 - features:

- Feed capacity dimensioned based on customer needs.
- Dimensioned to withstand up to 3,5m significant wave height (Hs).
- Spacious engine room prepared for the advanced power management system.
- Metallized above waterline to ensure high quality corrosion protection.
- 2 years paint warranty.
- Hull integrated mill tank of high processing capacity.
- Large deck with high loading capacity pr. m<sup>2</sup>.

\* AM 400 12S can only be delivered in a Comfort version.

Capacity	AM 400 12S	AM 320	AM 240
Feed capacity:	400 t (12 silos)	320 t (8 silos)	240 t (6 silos)
Silage:	Up to 50 tons	Up to 40 tons	Up to 30 tons
Diesel tank:	Up to 30 tons	Up to 30 tons	Up to 30 tons
Freshwater tank:	Up to 8m <sup>3</sup>	Up to 8m <sup>3</sup>	Up to 4m <sup>3</sup>
Sewage:	Up to 5m <sup>3</sup>	Up to 5m <sup>3</sup>	Up to 5m <sup>3</sup>
<b>Main Dimensions</b>			
Length (ex platforms):	27 m	28,4m	21,5m
Breadth:	12 m	10m	10m
Hull height:	4.0 m	3,5m	3,5m
Minimum freeboard:	1.159 m	1,182m	1,065m



Control room and living quarters  
Cabin level/ Deck level  
Storage/ Workshop

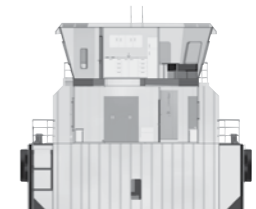

Gallery  
Wardrobes  
Machine room

# AJ 150/96 Classic/Comfort



AJ 150 Classic Med

# AWB 50 Work Barge



FEED BARGES

AWB 50 Work Barge

### AJ 150/96\* - features:

- Feeding capacity dimensioned based on customer needs.
- Dimensioned to withstand up to 3,0m significant wave height (Hs).
- Comfort model's raised control room, provides full view control over the silos and their cages.
- 2 years paint warranty.

\* AJ 96 can only be delivered in a Classic version.

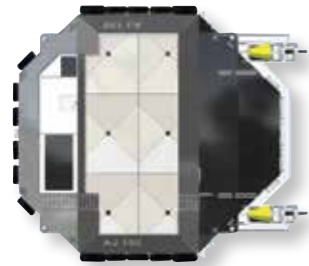

Silo deck

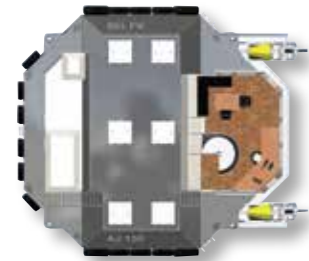

Control room, living quarters, silos



Control room and living quarters

Deck level Storage



Gallery

Machine Room

Capacity	AJ 150	AJ96
Feed capacity:	150 t (6 silos)	96 t (4 silos)
Silage:	-	-
Diesel tank:	Up to 12 tons	Up to 5,5 tons
Freshwater tank:	Up to 2m <sup>3</sup>	Up to 2m <sup>3</sup>
Sewage:	Up to 2m <sup>3</sup>	Up to 2m <sup>3</sup>
<b>Main Dimensions</b>		
Length (ex platforms):	13,3m	14,5m
Beam:	12m	8m
Hull height:	3m	2,2m
Minimum freeboard:	0,926m	0,947m

### AWB 50 Work Barge - features:

- Deck area of 17x5m designed for optimal cargo handling and operations.
- Dimensioned to withstand up to 3,5m significant wave height (Hs).
- Accomodation of 6.5x4m, with living room, kitchen, toilet and garage available areas.
- Metallized above waterline to ensure high quality corrosion protection.
- 2 years paint warranty.
- Max cargo capacity up to 100 tons (including deck cargo, excluding ensilage)



Control room, living quarters, deck area

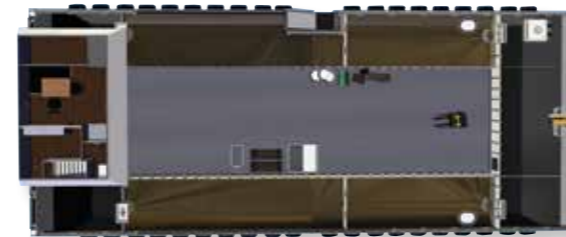

Machine room, storage



Pantry/WC  
Deck level Storage



Control room/  
Living room  
Machine Room

Capacity	AWB 50
Feed capacity:	50 tons
Silage:	Up to 125 tons
Diesel tank:	1 cubic meter
Freshwater tank:	Up to 125 tonn
Sewage:	1m <sup>3</sup>
<b>Main Dimensions</b>	
Length (ex platforms):	25m
Beam:	10m
Hull height:	2,2m
Minimum freeboard:	1,000m

# Wavemaster Feed Barges - Specifications

Model:	AB 650	AB 450	AC 850	AC 650	AC 600PV	AC 450	AC 350	AM 400 12S	AM 320	AM 240	AJ 150 Med	AJ 96	AWB 50
<b>Feed capacity</b>													
Loading capacity - feed (tons):**	650	450	850	650	600	450	350	400	320	240	150	96	50 (on deck)
Loading capacity - feed (m3):	1052	715	1377	1050	976	729	579	645	495	405	250	155	No silos
Number of silos:	8 alt. 4 silo hatches	6-8	16	12	8 alt. 4 silo hatches	6	8	12	8	6	6	4	
<b>Barge specifications*</b>													
Length - total (LOA) excl. platform m:	30	30	40,6	31,3	37,2	30	22	27	28,35	21,5	13,33	14,5	25,0
Beam - total (BOA) m:	19	19	12	12	12	19	10	12	10	10	12	8	10
Hull height (m):	3,6	3,3	4	4	5,2	3,3	4	4	3,5	3,5	3	2,5	2,2
Water proof sections: (Subject to app. reg.)	4	4	5	5	5	4	5	4	4	4	3	3	3
Min. freeboard Hs >=3m, stand. mooring:	1,21	1,0210	1,391	1,233	1,332	1,21	1,074	1,159	1,182	1,065	0,926	0,947	1,125
Min. freeboard Hs >=3m, cross mooring:	1,4	1,315	1,591	1,4	1,532	1,41	1,274	1,139	1,382	1,265	1,198	1,147	1,325
Deck house - options available:	Panorama/Comfort	Panorama/Comfort	Panorama/Comfort	Panorama/Comfort	Panorama V-bottom	Comfort/Panorama	Comfort/Panorama	Comfort	Comfort/Classic	Comfort/Classic	Comfort/Classic	Classic	
Veterinary/divers room possible:***	Yes	Yes	Yes	Yes	Yes	Yes	Yes	Yes	Yes	Yes	***	No	No
Biosecure zones:	Yes	Yes	Yes	Yes	Yes	Yes	Yes	Yes	Yes	Yes	No	No	No
Max number of generators:	4	3+1 small	3	3	3	4	3	3	3	3 (small)	2	1	1
Diesel tank, construction:	Steel	Steel	Steel	Steel	Steel	Steel	Steel	Steel	Steel	Steel	Steel	Steel	Steel
Diesel tank capacity (m3):	2x15	1x36	2x15	2x12	5x15	2x13	2x10	2x11,5	2x11,75	2x11,5	2x3-2x6	5,5	5,5
Freshwater tank, construction:	PE/GRP	PE/GRP	PE/GRP	PE/GRP	PE/GRP	PE/GRP	PE/GRP	PE/GRP	PE/GRP	PE/GRP	PE/GRP	PE/GRP	PE/GRP
Freshwater tank, capacity (m3):	2-10	2-6	2-8	2-8	2-6	2-10	2-6	2-8	2-8	2-4	1-2	1-2	1-2
Sewage, construction	Steel	Steel	Steel	Steel	Steel	Steel	Steel	Steel	Steel	Steel	Steel	Steel	Steel
Sewage tank, capacity (m3):	3-10	3-5	3-5	3	3-5	3-10	3-5	3-5	3	3	1-2	1-2	1-2
Silage tank, construction:	Painted steel	Painted steel	Painted steel	Painted steel	Painted steel	Painted steel	Painted steel	Painted steel	Painted steel	Painted steel	N/A	N/A	Painted steel
Silage tank, capacity (m3):	32-90	32-60	32-76	32-60	5x15	42	2x25	2x24	23-40	20-30	N/A	N/A	50-100
Mill tank, capacity, construction:	Integrated in the hull or aft platform	Integrated in the hull or aft platform	Integrated in the hull or aft platform	Integrated in the hull or aft platform	Integrated in the hull or aft platform	Integrated in the hull or aft platform	Integrated in the hull or aft platform	Integrated in the hull or aft platform	2 m³ stainless steel in aft platform	2 m³ stainless steel in aft platform			2 m³ stainless steel in aft platform
Control room + pantry (m²):	42	73	53/33,5	53/33,5	49,5	42	28	38	23/13	23/13	25	8	7
Living quarters, wardrobe, wc (m²):	69	12	45	45	42	69	22	39	23/8	23/8	29		
Workshop (m²):	63	67	24	24	35	63	18						
Technical room (m²):	30	47	36	36	36	30	21	54	28	28	8	4	
Machine room (m²):	72,5	58	36	36	36	72,5	39	72	46	30	27	16,5	17
Metallized above water line:	Optional	Optional	Optional	Optional	Optional	Optional	Optional	Optional	Optional	Optional	Optional	Optional	Optional
Certified according to:	NS 9415/NYTEK	NS 9415/NYTEK	NS 9415/NYTEK	NS 9415/NYTEK	NS 9415/NYTEK	NS 9415/NYTEK	NS 9415/NYTEK	NS 9415/NYTEK	NS 9415/NYTEK	NS 9415/NYTEK	NS 9415/NYTEK	NS 9415/NYTEK	NS 9415/NYTEK
Designed according to:	DNV 1A1 Barge R3	DNV 1A1 Barge R3	DNV 1A1 Barge R3	DNV 1A1 Barge R3	DNV 1A1 Barge R3	DNV 1A1 Barge R3	DNV 1A1 Barge R3	DNV 1A1 Barge R3	DNV 1A1 Barge R3	DNV 1A1 Barge R3	DNV 1A1 Barge R3	DNV 1A1 Barge R3	DNV 1A1 Barge R3
Optional equipment:	Please inquire	Please inquire	Please inquire	Please inquire	Please inquire	Please inquire	Please inquire	Please inquire	Please inquire	Please inquire	Please inquire	Please inquire	Please inquire
<b>Feeding system</b>													
Possible number of feed lines:	2-16	2-8	4-16	2-12	8 (12)	8	Max 8	6	Max 8	2-4	2-4	2-3	
Standard location of selectors:	Side	Side	Side	Side	Side	Side	Side	Side	Bow	Bow	Bow	Bow	
Air cooling system:	U-profile	110mm steel cooling pipes/ U-profile	U-profile	U-profile	U-profile	U-profile	U-profile	U-profile	U-profile	U-profile	Air-to-air cooler or U-profile	Air-to-air cooler or U-profile	

\*Barge specifications are subject to change without any notice. \*\* Density of 650kg/m³ \*\*\* Optional diver's room

## Certification guide, construction/anchoring:

The Wavemaster Feed Barges are designed in accordance with DNV 1A1 Barge R3 classification. Steel hull, superstructures and feed silos are manufactured using marine grade mild steel, type NVA or equivalent. All steel construction is

performed in accordance with NS470, and all welding is tested by certified NDT (Non Destructive Testing) inspector. The silo modules are constructed with corrugated steel plates in order to get smooth internal surfaces and a high strength to weight ratio (not all models).

High quality on all windows, watertight doors and hatches. Extended bow and aft platforms is available as options. Well proven design and construction, combined with innovation makes Wavemaster Barges reliable, efficient and seaworthy barges. A wide range of models are available at a competitive price.

**All barges are constructed according to NS9415:2009 Norwegian standard for floating fish farms. The barges are certified by Noomas.**

## APW Work Platform

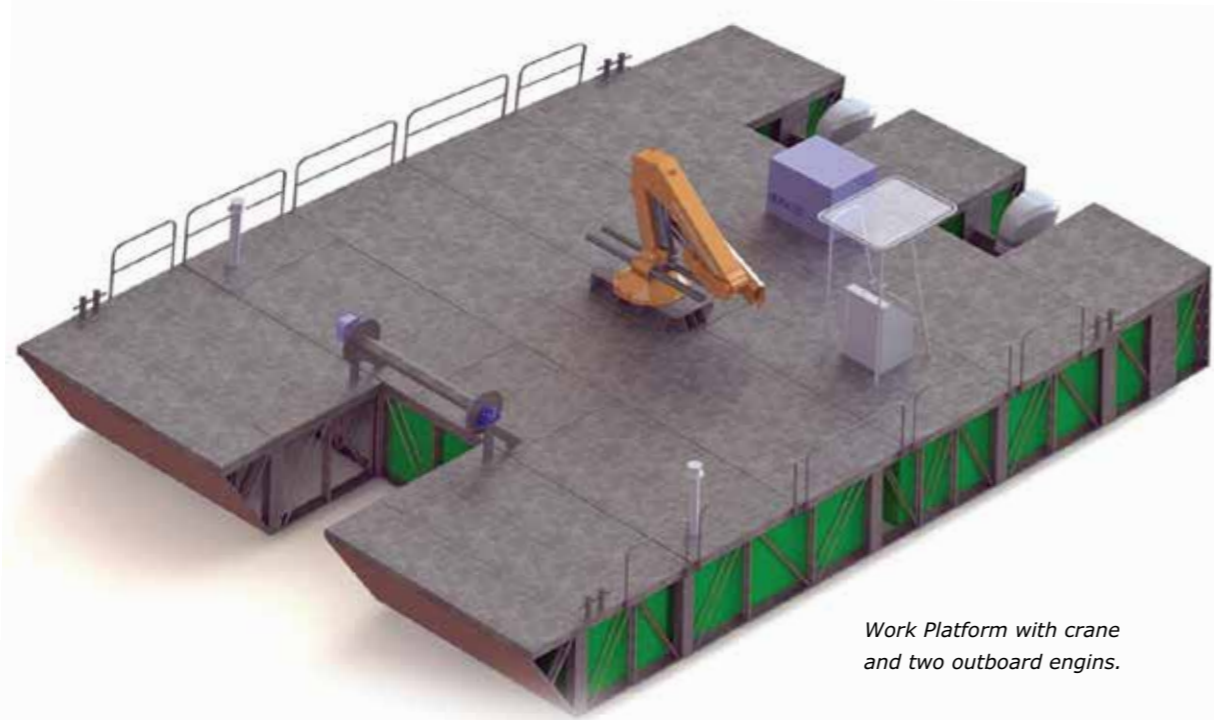

Work Platform with crane and two outboard engines.



Side view with floats and fendering.

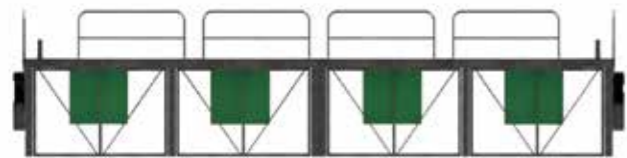

Side view with floats.

### Wavemaster Work Platforms

- Load-capacity dimensions calculated according to customer needs.
- The modular construction/solution allows for easy containerisation and shipment anywhere in the world.

Float grid below the platform.



**Local deck installation**  
The modules are transported to the location in parts and installed by experienced Wavemaster staff.



**Modular deck sizes**  
The deck modules can be offered in five different sizes; 6x5m, 8x5m, 10x10m, 20x10m and 30x10m.



**Withstands heavy loading**  
The modules are very stable and have a loading capacity from 6 tonnes up to 40 tons on the largest deck model.

## AP Platform Feed Barge



Transparent illustration showing silos and feed system. The house modules are flexible and can easily be tailor made for each location.

### Wavemaster Platform Feed Barge

- Load-capacity dimensions calculated according to customer needs.
- The modular construction/solution allows for easy containerisation and shipment anywhere in the world.
- All Platform Barges include a control room for the feeding process using a CCS Feed System, sensors and cameras.
- Silos with 3 tons capacity are located in the bow.
- Equipped with a chain hoist trolley to lift up the feed to fill the silos. The number of silos per barge can be adjusted.



**Tailor made platform barges**  
Tailor made solutions can be adapted for installation of any equipment that the customer need for the farm operation.



**Hot dip galvanized construction**  
All structural steel components are hot dipped galvanized after manufacture. This has proven to be the most effective and durable coating for use on fish farming structures.



**Designed for remote locations**  
The latest feed technology can be shipped to lakes and places that were inaccessible before..

# Wavemaster APW Work Platform - Specifications



Deck models:	APW 30	APW 40	APW 100	APW 200	APW 300	Comments
Length - Total (LOA) m:	6	8	10	20	30	
Beam - Total (BOA) m:	5	5	10	10	10	
Deck (m <sup>2</sup> ):	30	40	100	200	300	
Load capacity:	6 tons	9,7 tons	13 tons	27 tons	40 tons	
Depth to deck (mts):	1,5	1,5	1,5	1,5	1,5	
Freeboard full load, standard:	400mm	400mm	400mm	400mm	400mm	
Floats standard:	Rotational Moulded Polyethen	Rotational Moulded Polyethen	Rotational Moulded Polyethen	Rotational Moulded Polyethen	Rotational Moulded Polyethen	Color on request (styrofoam filled)
Floats Increased Freeboard:	Rotational Moulded Polyethen	Rotational Moulded Polyethen	Rotational Moulded Polyethen	Rotational Moulded Polyethen	Rotational Moulded Polyethen	Colour on request (styrofoam filled)
Handrails:	Optional	Optional	Optional	Optional	Optional	
Mooring points:	4	6	6	10	14	Mooring plate or pipes with flared bottom openings
Fendering:	Yes	Yes	Yes	Yes	Yes	Along sides on request
Deck:	2-3mm stamped plate, 32x5 grating, 4 mm checkered plate	2-3mm stamped plate, 32x5 grating, 4mm checkered plate	2-3mm stamped plate, 32x5 grating, 4mm checkered plate	2-3mm stamped plate, 32x5 grating, 4mm checkered plate	2-3mm stamped plate, 32x5 grating, 4mm checkered plate	
Hot Dipped Galvanizing:	Certified according to ASTM 123	Certified according to ASTM 123	Certified according to ASTM 123	Certified according to ASTM 123	Certified according to ASTM 123	
Duplex System (Galvanizing + Painting):	Available on request	Available on request	Available on request	Available on request	Available on request	
Cathodic protection:	Available on request	Available on request	Available on request	Available on request	Available on request	
Other equipment:	Please inquire	Please inquire	Please inquire	Please inquire	Please inquire	



## Safety details

All decks and platforms are supplied with all the safety gear required for the country of operation as a minimum. Typical standard / optional safety equipment may include: Safety handrails and non-skid surfaces, life rings with heaving line, boarding ladders, etc.

## Design & Construction

All Wavemaster modular decks/platforms are designed/built supervised by professional naval/mechanical engineers. All welders are certified under AWS D1.1/D1.1M ed.2010



Rugged and UV stabilized rotational moulded MDPE Floats, filled with expanded Polystyrene foam.

# Wavemaster AP Platform Feed Barge

Platform models:	AP 50	AP 100	AP 150	AP 200	AP 300	AP 400	Comments
<b>Feed capacity</b>							
Loading capacity:	50 tons	100 tons	150 tons	200 tons	300 tons	400 tons	
Number of silos:	2-4	2-4	2-4	2-4	2-6	2-6	
<b>Barge specifications</b>							
Length - Total (LOA) m:	20	26	33	40	40	50	
Beam - Total (BOA) m:	12	12	12	12	17,5	17,5	
Depth to deck (mts):	1,5	1,5	1,5	1,5	1,5	1,5	
Freeboard full load (Standard Floats):	400mm	400mm	400mm	400mm	400mm	400mm	
Standard Floats:	Rotational Moulded Polyethen	Rotational Moulded Polyethen	Rotational Moulded Polyethen	Rotational Moulded Polyethen	Rotational Moulded Polyethen	Rotational Moulded Polyethen	Colour on request
Floats increased freeboard:	Rotational Moulded Polyethen	Rotational Moulded Polyethen	Rotational Moulded Polyethen	Rotational Moulded Polyethen	Rotational Moulded Polyethen	Rotational Moulded Polyethen	Colour on request
Handrails	Optional	Optional	Optional	Optional	Optional	Optional	
Mooring points:	10	10	10	12	12	14	Mooring plate or pipes with flared bottom openings
Fendering:	Yes	Yes	Yes	Yes	Yes	Yes	Sides on request
Flooring:	4mm checkered plate	4mm checkered plate	4mm checkered plate	4mm checkered plate	4mm checkered plate	4mm checkered plate	Others on request
Discharge area (stern,m <sup>2</sup> ):	24	24	24	24	35	35	
Control Room (m <sup>2</sup> ):	14	14	14	14	14	14	
Room + Toilets (m <sup>2</sup> ):	14	14	14	14	14	14	Additional on request
Fuel Tank:	1000 to 4000 lts	1000 to 4000 lts	1000 to 4000 lts	1000 to 4000 lts	1000 to 4000 lts	1000 to 4000 lts	Optional
Hot dipped galvanizing:	Certified according to ASTM 123	Certified according to ASTM 123	Certified according to ASTM 123	Certified according to ASTM 123	Certified according to ASTM 123	Certified according to ASTM 123	
Duplex System (Galvanizing + Painting):	Available on request	Available on request	Available on request	Available on request	Available on request	Available on request	Extra protection for harsh environments
Cathodic protection:	Available on request	Available on request	Available on request	Available on request	Available on request	Available on request	
Others Equipments:	Please inquire	Please inquire	Please inquire	Please inquire	Please inquire	Please inquire	
<b>Feeding System</b>							
Number of possible feedlines:	2-4	2-4	2-4	2-4	2-6	2-6	
Standard placement of selectors:	Bow	Bow	Bow	Bow	Bow	Bow	
Aircooling System:	Optional	Optional	Optional	Optional	Optional	Optional	

## Certification and construction/anchoring:

Wavemaster Modular Decks and Platforms are designed and built supervised by professional naval and mechanical engineers to meet all required regulations. Steel hulls, superstructures and feed silos are manufacturing-certified steel.

All welders are certified under AWS D1.1/D1.1M, and all welding is tested by a certified NDT (Non Destructive Testing) inspector. As a standard all the deck/platform are hot dip galvanised in accordance with ASTM 123.



## Feed Systems

### Matches fish appetite

The central feed system concept was invented by AKVA group in 1980 and Akvasmart CCS is today the most popular and reliable feed system world wide. The system is suitable for all species feeding on pellets. It is now also fully integrated with camera control and environmental sensors, as well as Fishtalk production control software. All feeding and environmental data is stored in the Fishtalk database. This unique integration allows for full overview and control of all operational activities from farm site to top management level.

The Akvasmart CCS Feed System will feed the correct amount, at the optimal rate, on time and every time. This powerful system provides great opportunities to optimize the entire feeding process.

AKVAconnect is the leading edge feed system software, now part of the Fishtalk software family. New functionality includes meal planner, group feeding and adaptive feeding. Combined with data from environmental sensors, this allows for efficient analysis and benchmarking between farm sites.





**Software**

**The Feed System**

The Akvasmart CCS Feed System is designed to handle more than 40 feed lines running in parallel and more than 1000 cage/tank units, centralized- or hopper feeders, all operated from one PC, iPad or smartphone.

Akvasmart CCS is the perfect choice for feeding fish, designed to fit the requirements from low capacity system such as CCS-32, up to high capacity systems such as CCS-110.



**Wireless Transmitter**

Digital CAP transfers video and sensor data in real-time. Integrated surface camera.

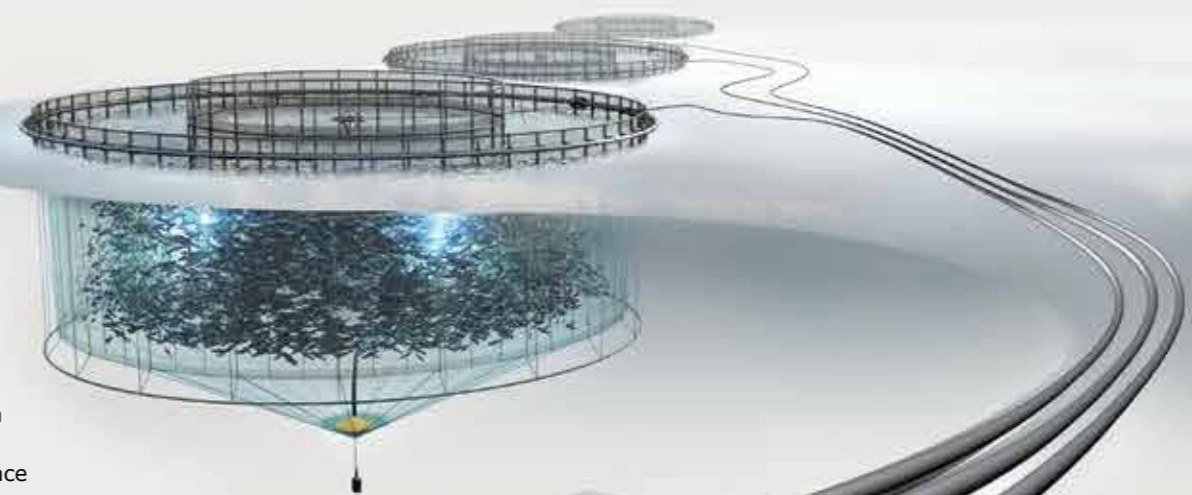

**Feed Blower**

Generates transport air for the feed system.

**Feed Silos**

Up to 8 silos can be connected in series for each feed line.

**Cleaning Plug Injector**

The Cleaning Sponge is inserted into the feed system via the Feed Pipe Cleaner, and will be transported through the system by using pressured air. The sponge will attract feed residues and condense when going through, reducing deposits inside the pipes to a minimum.



**Akvasmart CCS Feed Systems and components are tested through decades to ensure gentle feed handling.**

**Air Cooler**

Reduces the temperature of the transport air above the surface.

**Air Control system**

Regulated air speed and keeping the pellet in the gentle feed handling area significantly reduce the risk of blockage and feed breakage.

**Feed Dosers**

With capacities from 0,6kg/min up to 192kg/min. Up to 8 dosers can be connected in series for each feed line.

**Feed Selector Valve**

Distributes feed to the correct cage and ensures gentle feed handling. The Selector Valves can be offered with connections from 4 to 60 feeding pipes.

**Integrated accessories**

A wide range of Akvasmart units such as sensors, cameras, and rotor spreaders can easily be integrated to the CCS Feed System.

**Feed Pipes**

A wide range of high quality and durable Polarcirkel Feed Pipes are available in various dimensions and coil lengths up to 1000 metres.



Environmental Sensors



Camera Systems



Network Systems



Underwater Lights

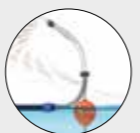

Rotor Spreaders



**AKVA Basic - a compact feed system solution**

Easy installation, operation and low maintenance makes AKVA Basic an ideal and reliable equipment on smaller locations or isolated farms.

Feed accounts for 60-90% of the production cost in most fish farming around the world today. That makes every pellet count when it comes to financial results.

## Feed Care



### Important elements in the feeding process

- **Feed storage, how to:**
  - Fill silo
  - Store feed
  - Take feed out of silo
- **Pellet transport**
  - Pipe work
  - Connections
  - Adjustment
  - Cleaning
- **Air transport**
  - Air temperature
  - Cooling
  - Air speed
  - Back pressure
- **Adjustment in control system**
  - Feeding speed
  - Air speed
- **Feed spreading**
  - Type of spreader
  - Spreading area
- **General maintenance**
  - All equipment

All issues above are down to how to transport the pellet undamaged to the fish!



### Commercial Scale testing

AKVA group has developed a special feed durability test machine (Doris) that makes it possible for farmers and feed manufacturers to test and document the physical quality of different feed types. We work closely with experienced feed suppliers to optimize feed handling.

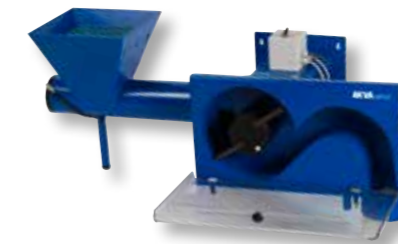

Our patented feed test unit "Doris", is also used by leading fish feed manufacturers and other aquaculture companies.



Video control of the pipes.

Monitoring and regulating the transport air speed is one of the most important factors. "Speed kills" also when it comes to feed systems, and only a 10-20% reduction of transport air speed make a significant reduction in feed dust and pellet breakage. This is where most of the feed dust has been created historically. Using the Air Control System combined with our highly effective (low friction start) Rotor Spreaders allow reduction in air speed while still getting excellent spreading.



Centre of Aquaculture Competence. The world's largest full scale test site for salmonidae is owned by Marine Harvest, Skretting and AKVA group.

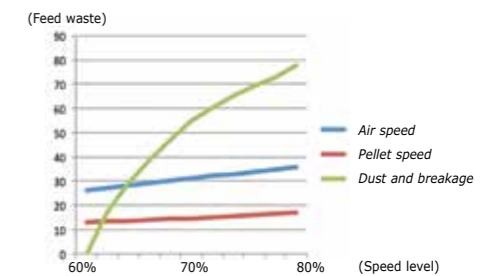

Graph showing how pellet speed influences dust and breakage.

### Preventing up to 3% feed waste

It is quite common for large scale fish farms today to spend 10-20.000 US\$ average per day in fish feed. Preventing only 1% feed waste (dust and breakage) can add a total of 50 - 100.000 US\$ to the bottom line each year! Consequently, it is critical that your feed system reliably deliver the feed to the fish 100% intact, at the correct rate, exactly the amount the fish wants to eat and with optimal spread.



All feed system equipment is tested by experienced AKVA group technicians to make sure all equipment meet our high standard.



**Feed Blowers**

The blower generates the air pressure to transport the feed to each tank/cage. The combination of air control system and frequency regulated blowers makes it possible to optimize the pellet transportation. The air speed can be adjusted to optimize both feed spread and gentle feed handling. The blowers are delivered in high quality silencer cabinets which ensures a comfortable work environment.



AKVAconnect provides detailed feeding data from the silos to the cages/tanks.

The feed enters the air flow through the Doser Valves and is then blown through seamless stainless pipes and up to the Selector Valves.



Inspection of a Feed Blower installation, noise cabinets with easy access.

Sound protected machine room with Feed Blowers and generators.

**Air Coolers**

Depending on the transport distance and ambient temperature, many feed types and feed systems will benefit from installing air cooling systems.

Too high temperature may cause lipids to be released from the pellets and even proteins to be denaturated. This will lower the nutritional value of the feed.

If the lipids are released from the feed during transportation this will increase the risk of pipes being blocked hence increasing the need for pipe cleaning.



Feed blowers and air coolers come in a variety of models.



The cooling pipes are integrated in the hull construction on most of our Feed Barges.



AKVAconnect process control offers special alarm functions for air control (speed, temperature and back-pressure).

**Air Control System**

Akvasmart Air Control System with regulated air speed ensures optimal pellet flow, significantly reducing the risk of blockage and breakage. If the pellet/air speed is too low, the risk for pellet blockage is increased. If the pellet/air speed is too high, dust and breakage is increased. The system also monitors and logs air speed, back-pressure and temperature.



The Air Control unit is installed between the Air Cooler and Feed Doser Valve.

The control system is visualized in AKVAconnect through a simple graph per feeding line. The graph displays real-time data for each unit being fed.



Too low pellet speed.



Optimal pellet speed.



Too high pellet speed.

## From silo to fish - A critical part of the feed transport



## Feed silos, Augers and Feed Doser Valves

### Feed Doser Valves

A custom Feed Doser Valve is used to transfer the feed into the air flow. As this is a critical part of any feed system, it is important that only FEED CARE OPTIMIZED equipment is used. In order to meet all our customer's needs, we can offer both Feed Doser Valves and Feed Augers with Sluice Valves for this purpose. The CCS Feed Doser Valves are designed in two main models. Vari Doser 1500" and Feed Doser 4000".

Service and cleaning of the feed doser can easily be done in 30 minutes. See more details in our user manual.



The Feed Doser Valves have capacities from 0,6kg/min. up to 192kg/min.

### Silo Systems

A wide range of different feed tank solutions and sizes can be delivered to suit any requirements. We can deliver square or round silos in both aluminum and steel. Contact our sales department for more details and specifications.



Feed silos can be delivered in wide range of types, shapes and sizes.



A smart silo outlet gate, made from galvanized steel, can easily be installed at the doser top in between the silo flange and feed doser valve.

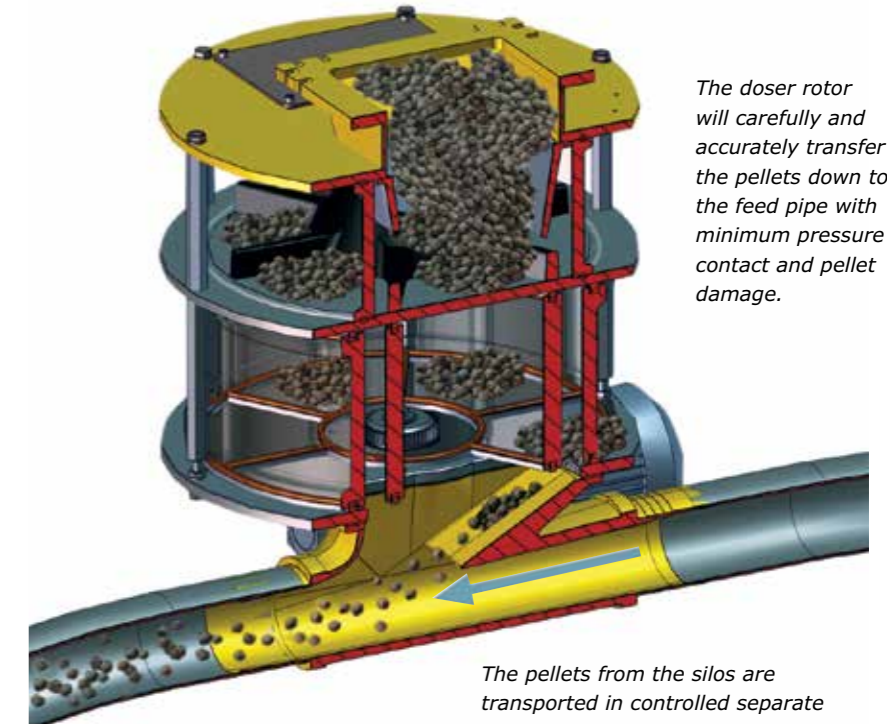

The doser rotor will carefully and accurately transfer the pellets down to the feed pipe with minimum pressure contact and pellet damage.

The pellets from the silos are transported in controlled separate doses to the feeding pipe below and then blown to each cage.



### Feed Auger

The Feed Auger is a well proven solution to transfer the feed into a gate valve. The Auger provides more flexible installation, simpler pipe systems and easier maintenance.



Feed Auger/Dosers:	Feed Auger	VariDoser Start	VariDoser	Doser 4000
Min. feed rate (kg/min):	12	1,8	6	12
Min. feed rate pulse (kg/min):	9	0,9	4,5	9
Max feed rate (kg/min):	100*	24	75	150
Material:	316 Stainless steel	Polyethen (PE) / Cast iron / Stainless steel		
Weight:	50kg	75kg	75kg	95kg

\* With appropriate settings

The leading feed concept since 1980



## Feed Selectors

### Feed Selector Valve

The Feed Selector Valves are programmed to distribute the feed to the correct cage through the PE feeding pipes. The pipes are exposed to the full forces of the ocean, and consequently we have designed a very rugged strain relief bracket that can handle the expected loads and makes it easier to replace the pipes. Our product line includes a wide variety of Selector Valve models with connections from 4 to 60 feeding pipes (depending on model).



The CCS system is designed to withstand the extreme forces of weather and salt corrosion.



Feed Selectors can easily be installed at the front or the side of the barge.

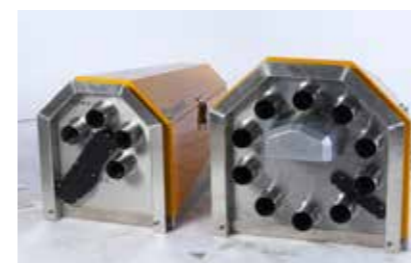

A new improved construction makes the Feed Selectors easier to open, clean and maintain.



New rugged strain relief bracket.

Pipe length up to 1400m.

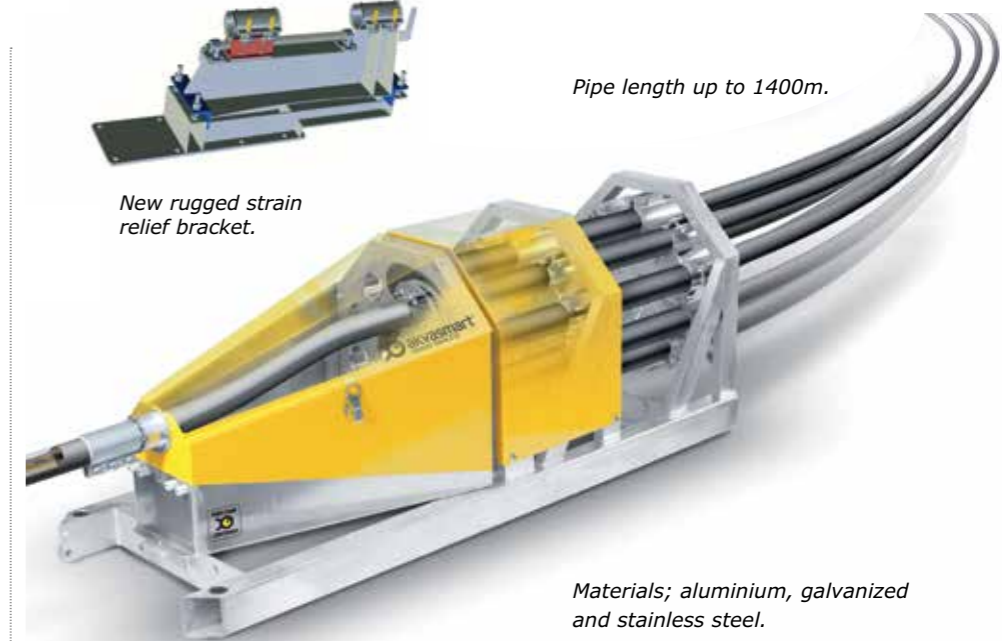

Materials; aluminium, galvanized and stainless steel.

Pellet sizes from 1.2mm up to 25mm+.



The new Wavemaster AC650 Feed Barge has 12 silos and 6 Feed Selector Valves.



Feed Selector	CCS32	CCS63	CCS90	CCS110
PE pipe dimension:	32mm (1")	63mm (2")	90mm (3")	110mm (4")
Max pellet size:	5-7mm	9-12mm	25mm (1")*	25mm+ (1")*
Outlets:	32-60	24-32	4, 10 or 24	4 or 8
Materials:	Stainless Steel/ Aluminum	Stainless Steel/ Aluminum	Stainless Steel/ Aluminum	Stainless Steel/ Aluminum
Weight:	45-55kg*	45-55kg*	50-65kg*	50-65kg*

\* Depending on model/ex. pipe restrainer

# Rotor Spreaders



## Faster and more even growth and better feed care with adjustable feed spread

### Extra careful feed handling

One of the most important factors for gentle feed handling is regulating transport air speed. "Speed kills" also when it comes to feed systems.

Akvasmart Rotor Spreaders are designed to provide excellent feed spread in cages. All our models have adjustable light weight aluminium rotor pipes that allow for lower air speed for start-up and rotation. This means less dust and breakage, power consumption, back pressure, air temperature, noise and wear and tear on the feed pipes. Our unique ventilated Zenon bearing requires no regular cleaning and does not corrode.



Akvasmart Rotor Spreader Hex has a light weight construction, and is easy to install and to move around.



Preventing only 1% feed waste in a larger fish farm can add a total of 50 - 100.000 US\$ to the bottom line each year!

**Akvasmart Rotor Spreaders are easy to install and simple to maintain.**

The new Rotor Spreader Hex with unsinkable floating base. No protruding parts eliminates the risk of net damaging or harming the fish in the cage.

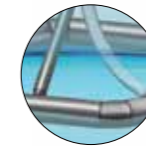

A light weight but strong construction ensures reliable performance in rough water.



Foam filled HDPE pipes - Will never sink.

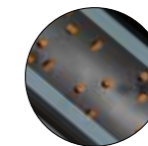

The twistable rotor tip are less curved and ensures more gentle feed care.

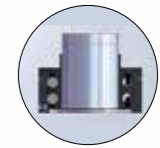

The new ventilated bearing has extra low friction and requires no regular cleaning and does not corrode!

RS-63 and RS-90 have a heavy keel weight in galvanized steel is keeping them stable in rough seas.



Rotor Spreader	RS-63C	RS-90C	CF-90
PE pipe dimension:	63mm (2")	90mm (3")	90mm (3")
Max pellet size:	12mm (1/2") *	25mm (1") *	25mm+ (1") *
Recommended RPM:	50-100 *	50-100*	50-100 *
Spread diameter (adjustable):	Approx. 4-12m Ø * Approx. 12-40' Ø *	Approx. 5-18m Ø * Approx. 16-60' *	Approx. 5-18m Ø * Approx. 16-60' *
Materials:	Stainless Steel/Alum. Rotor/POM (Delrin) Polyform buoy	Stainless Steel/Alum. Rotor/POM (Delrin) Polyform buoy	Stainless Steel/ Alumium/POM Floating ring: HDPE
Height above water:	1,2m (4')	1,2m (4')	1,5m (4'9")
Draft:	1,8m (6')	1,8m (6')	0,1m (3.3')
Total weight:	Approx. 30kg (66 lbs.)	33kg (73 lbs.)	35kg (77 lbs.)

\* Depending on feed system and feed type. (RS spreader can also be delivered in a 110mm version.)

# AKVA Subsea Feeding System



■ Subsea feeding combined with sub lights will keep the salmon in deeper waters.

## Effective feeding that provides increased growth and improved fish welfare



The cyclone is equipped with a floating element, which is easy to place and move during maintenance and other necessary operations.



The fish will be fed 7m below the surface, where the sea is calmer.



Aurora SubLED 1350 - a combination of anti-maturation light and UV-light will keep the salmon in deeper waters.

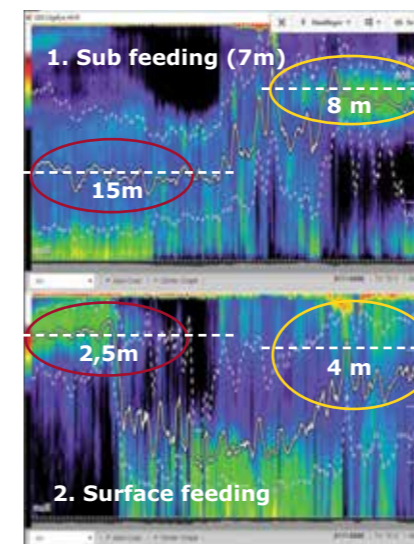

Screen 1 above shows that the salmon now reside in deeper waters, most of the time around the feeding points.

AKVA Subsea Feeder is an underwater feeding system that feeds fish at a depth of approximately 7 metres. The feed is transported to the cages through a regular air hose. Water is added and passed down through a main pipe. The water is added by using a pump that draws deep water of good hygiene, in order to ensure the required speed of the feed. The feed is then spread using a dispersion unit of 17 meters in circumference with 12 feeding units so that the feed is spread about the cages in a satisfactory manner. The feeding rate is up to 50kg of feed per minute. Experience from using the system shows that bird netting is not required.

### The principal advantages:

- Fast and efficient underwater feeding (approx. 50kg/min.)
- Good feed distribution • Good hygiene
- Easy to operate and maintain
- No bird netting required
- Certified in accordance with NS 9415.

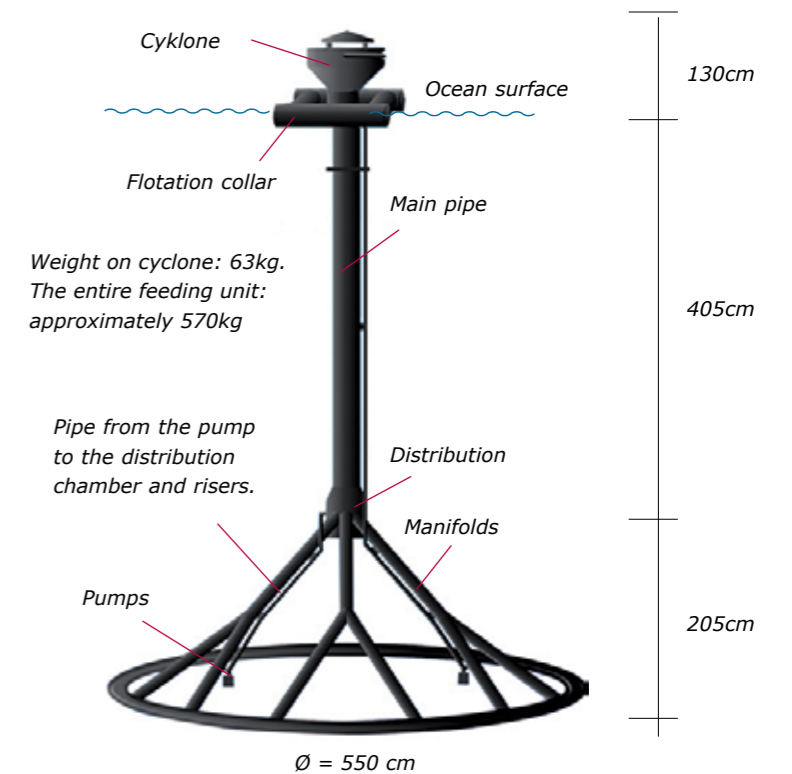

### Promising test results

The AKVA Subsea Feeder has been tested by a salmon farming company, SinkabergHansen, and initial tests show that the salmon exhibit good growth and welfare because sea lice infestation is reduced. Experience so far shows that the fish remain by the feeding point during daytime.

Further tests will be carried out over the coming year. The tests will include the use of light in combination with the AKVA Subsea Feeder, and tests will be carried out at salmon farms in several locations along the coast. The tests will be carried out collaboratively with a research institute and the results of the tests will be publicly accessible.

## Feed System capacities and transport lengths



The Akvasmart CCS Feed System is designed to fulfill all feeding requirements, regardless of species or how you want to feed your fish.

The configuration of the system is based on the following factors:

- Transport lengths
- Biomass (feed amount)
- Number of units (cages)
- Species

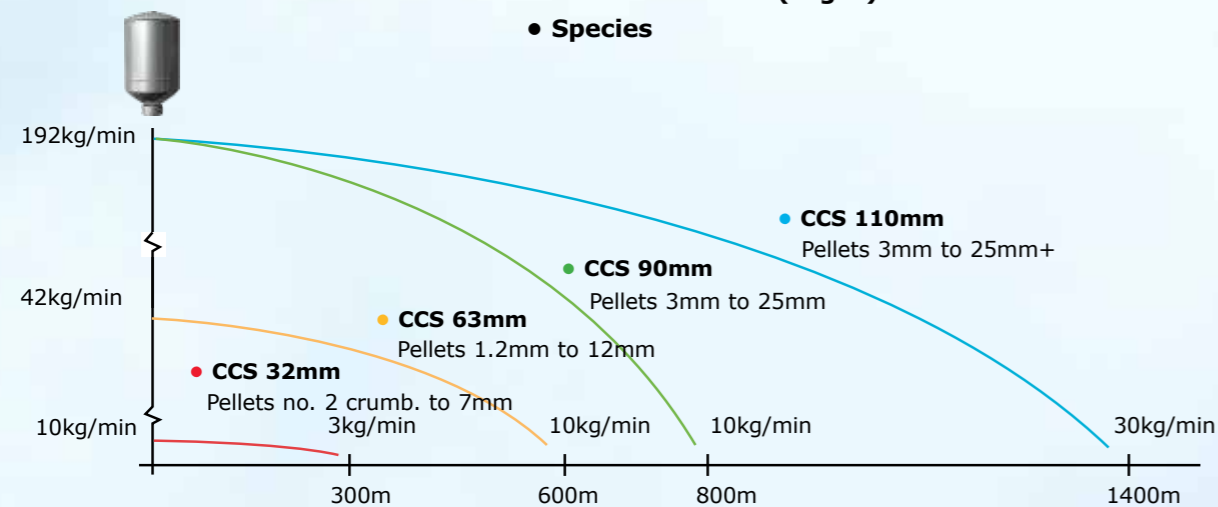

\* The capacity of the feed system depends on the technical quality of the pellet, the feeding regime as well as the length of the feed pipe.

## Feed System Specifications

System		CCS-32	CCS-63	CCS-90	CCS-110	Comments
Feeding pipe size:	OD (mm)	32 (1")	63 (2")	90 (3")	110 (4")	Imperial (North America)
Wall thickness:	(mm)	2,9 (0,11")	4 (0,16")	7 (0,28")	6,3 (0,25")	
<b>Feeding data (for each feed line):</b>						
Pellet sizes: */**	Max.(mm)	5 - 7	9 - 12	17 - 25	25+	
	Min.(mm)	No.2 crumb.	1,2	3	3	This must be evaluated in each specific case.
Max. feeding capacity: */**/**	kg/hour	648	2 520	5 220	5 220	with "VariDoser 1500"
		-	-	11 520	11 520	with "FeedDoser 4000"
Max. feeding rate: */**/**	kg/min.	10,8	42,0	87,0	87,0	with "VariDoser 1500"
		-	-	192	192	with "FeedDoser 4000"
Min. feeding rate: */**/**	kg/min.	1,2	2,4	3,0	3,0	
Min. feed dose (single dose) */**	grams	10	20	40	50	with "VariDoser 1500"
		-	-	200	200	with "FeedDoser 4000"
<b>Transport lengths:</b>						
Max. feed pipe length:	m					*/**
Max. feeding rate at max. feeding pipe length:	kg/min.	3,6	12	10	30	***
Max. feeding rate at half of max. feeding pipe length:	kg/min.					***
Max. feeding rate at short feeding pipe length */**	kg/min.	10,8	42,0	87,0	87	with "VariDoser 1500"
		-	-	192	192	with "FeedDoser 4000"
<b>Power consumption (max):</b>						
Feed Blower:	kW					
FeedSelector Valve:	kW	0,18	0,18	0,18	0,18	
Feeder: FeedDoser/ VariDoser:	kW	0,37	0,37	0,75	0,75	Max. load/unit
Feeder: Auger & Sluice Valve:	kW	1,5	1,5	1,5	1,5	

\* Depending on actual transport distance \*\* Depending on type of feed, technical feed quality, pellet size, feed rates and system settings  
\*\*\* At continuous feeding

PE Feeding pipes /antistatic pipes	Dimensions				
	OD	ID	Wall thickness	SDR**	Weight/m
32mm	32mm	26,2mm	2,9mm	11	280g/m
63mm	63mm	55mm	4mm	15,75	750g/m
75mm*	75mm	66,4mm	4,3mm	17,6	980g/m
90mm*	90mm	79,8mm	5,1mm	17,6	1390g/m
90mm	90mm	76mm	7mm	12,8	1900g/m
110mm	110mm	97,4mm	6,3mm	17,6	2090g/m

\* Not standard dimensions for Akvasmart CCS Feed System. \*\* SDR = Outer diameter (OD) / Wall thickness.

We can offer three control cabinets in various sizes for the feed systems. Ask our sales offices for more specifications.



AKVAconnect is a powerful and advanced software for daily control of all your feeding processes. Combined with Akvasmart CCS Feed System, it is the most adaptable and user friendly system on the market. AKVAcontrol is developed over the last 30 years in close cooperation with fish farmers all over the world. This has resulted in full integration with camera systems, pellet- and environmental sensors.



The new AKVAconnect process platform provides full overview and control.

**Biological approach**

The only feed system software with biomass regulated feeding regimes based on accurate monitoring of fish appetite and environmental data.

**Environmental sensor data**

Oxygen-, temperature- and current sensors are fully integrated in AKVA control. All sensor data are displayed in real time and logged for further analysis. This allows for optimal feeding at all times.

**Fishtalk software integration**

Data generated in AKVAconnect is accessible in Fishtalk Control, providing end-to-end production overview, control, analysis, benchmarking and reporting.

**The most adaptable and user friendly feeding system on the market.**

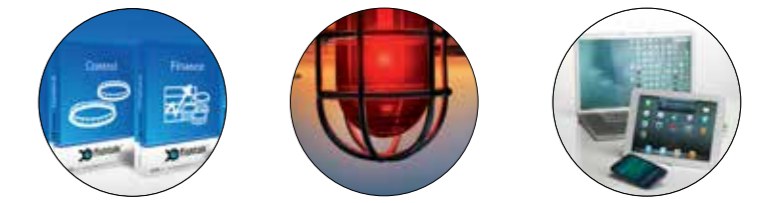

All feeding data is easily accessible in Fishtalk Control. Alarm output to site alarm. The feeding can be remote controlled from an iPad or smartphone.



Accurate monitoring of fish appetite. Environmental data displayed in real time and logged. Automatic or manual camera selection. Feeding according to received data.



**Key functionality:**

- Full farm overview at a glance
- System capacity planning
- Advanced meal planning
- Multiple group feeding regimes
- Hopper control
- Integrated feeding camera control
- Accurate Air Control System
- Wizards
- Powerful reporting and analysis tools.



## Camera and Sensor Systems

Full overview and complete control with AKVAconnect

Akvasmart's advanced video camera and sensor systems monitor both the fish and the feeding process. This ensures optimum operations and a healthy environment for the fish.

Flexible camera solutions, like monochrome feeding cameras or winch controlled pan & tilt 360° Twin colour cameras, provides crystal clear pictures. Wireless transmission of surface and underwater video images, feeding- and environmental data to the farm base.



## Dedicated camera solutions



## Underwater- and surface cameras

Akvsmart cameras have been produced for more than 20 years. Based on this experience AKVA group has a wide product range of cameras from basic fixed monochrome and dual pan/tilt colours to surveillance cameras tailored for aquaculture. Akvsmart cameras can be used to monitor:

- Underwater feeding activity
- Surface feeding activity
- Fish maturation
- Fish behaviour
- Morts at the cage bottom
- Fish parasites (i.e. sea lice)
- General surveillance



*The video camera looks straight up towards the surface during the feeding in order to see uneaten pellets.*



*Akvsmart cameras can monitor fish surface activity and feed spread, even in poor light conditions.*

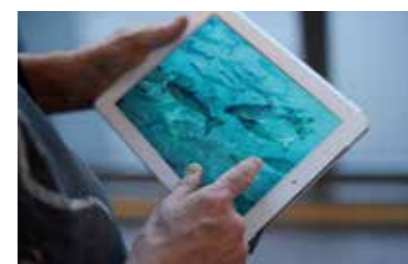

*Fast and accurate camera and winch control using a PC or iPad.*

Robust and waterproof connection cable.



C A M E R A S



Synchronized endless 360° pan and tilt.

Advanced upper colour video camera and a high light sensitive monochrome or colour underwater camera.

### Akvsmart Winch V5

New smart suspension that prevents spinning. Analogue speed, steering on both drums, they can be run with different speed. Moment locker that turns out on programmed power features. Wireless operation via digital CAP. Optional location. Directional round counter calculates where the camera is located. Optional oxygen/temperature connection. Status link on the buttons. 220V operation.



### The winch is prepared for:

Internal temperature and moisture measurement, can warn a prior leak. Future Software upgrades. Positioning with several favorite settings. Profiling and cyclically operation. Reduced operation at night.

Akvsmart Winch V5



SmartEye Cameras



Digital CAP



Monitor



Portable PC/ iPad

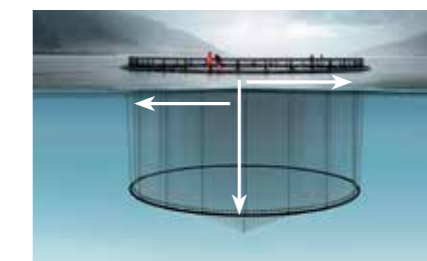

*A flexible Akvsmart Winch V5 allows easy and accurate vertical and horizontal positioning inside the cages.*



*Cameras, cables and connection plugs are pressure tested to ensure that the equipment is 100% water proof.*

# Crystal clear first choice feeding cameras

**Basic HR Feeding Camera** - The Akvasmart HR cameras are the world's most popular feeding camera series. These are stationary cameras hanging below the fish' eating area (typically 5-8m) aiming straight up to detect uneaten pellets sinking towards the camera. Basic HR is a simple, reliable and affordable monochrome camera and a smart choice if you need effective feeding control in cage. Recommended use: Tanks and smaller cages.



**Super HR Feeding Camera** - All of our HR-cameras can be used with Akvasmart hardwired or wireless camera systems and can be operated from the cage, a workboat, feeding control room or via the Internet. One camera is usually permanently installed in each cage. The Super HR Feeding Camera is a rugged and reliable high-resolution monochrome camera designed for use under all conditions. Recommended use: Tanks, medium and smaller cages.



**SmartEye Double Camera** - In-water camera with the ability to switch between look up and look down camera via AKVAconnect process view. This requires WiFi or Fibre based system. Switching between look up and look down is performed using the I/O on the Axis Video server in conjunction with small switch board. Can also be used with a Digital CAP. Recommended use: Tanks, medium and smaller cages.



**SmartEye 360 Twin** - Smart Eye 360 Twin ULL version is the best possible camera for darker light conditions. It has two monochrome cameras that are very light sensitive, and they deliver excellent video images when looking down into deep and dark cages. ULL = Ultra-low light. Smart Eye 360 Twin Colour/ULL camera configuration includes a high resolution colour camera pointing up, and a ULL monochrome camera pointing down. Smart Eye 360 Twin Colour is an advanced double feeding and inspection colour camera with unique features.

The Smart Eye 360 Twin camera is delivered in three different versions, they are all delivered without external moving parts, and thus a massive reduced risk of leaks. All SmartEye 360 Twin cameras include two cameras, one pointing down towards the bottom of the cage, and one that is pointing upwards. Both cameras are synchronized for 360 degrees movement with one joystick for full overview. These cameras are installed in the cage and are operated from a work boat, the feeding control room and via the internet. It provides sharp underwater video images. SmartEye 360 Twin cameras are also available with built-in depth- and temperature sensor. Recommended use: Medium and large cages.



# Camera Specifications



Cameras	SmartEye 360 Twin ULL	360 Twin VVK ULL	360 Twin 2 color	Double Camera	Super HR	Basic HR
Colour Up/down:	Mono/mono	Color/mono	Color/mono	Colour	Monochrome	Monochrome
Type:	Analog	Analog	Analog	Analog	Analog	Analog
Resolution:	570 TVL	1000TVL-1280H/570 TVL	650 TVL	650 TVL	600 TVL	600 TVL
Angle of view:	Fix: 54°	50,4° 64,5°/50,4°	Fix: 72°	Fix: 70°	Fix: 72°	Fix: 72°
Cable:	75m (246')* PUR	75m (246')* PUR	75m (246')* PUR	30 to 100m (99-328') PUR	30m to 100m (99-328') PUR	30 to 100m (99-328') PUR
Depth rating:	75m (246')*	75m (246')*	75m (246')*	100m (323')*	100m (323')*	100m (323')*
Power:	12V DC	12V DC	12V DC	12V DC	12V DC	12V DC

\* Limited by cable

# Surveillance Cameras - Complete overview of your barges and sites

SmartHawk Surveillance cameras provide better control over unwanted visitors, predators, feed spread or simply added safety when working alone at the farm.

These are advanced IP cameras with powerful 32x optical zoom, clear pictures and smart functionality, which can easily be operated from the cage, workboat, control room or via Internet.



Surveillance cameras provides added safety when working alone on the feed barge.



The cameras can monitor the deck, machine room, feeding system or other vital areas on the barge.



The surveillance camera can pan 360° and tilt 90°.



The Surveillance cameras have full color but they will switch to monochrome under low light conditions.

**■ Detects predators and unwanted visitors and increase safety and overview.**

Surveillance Camera		
Colour:	Colour	Colour
Type:	Network	IP
Resolution:	D1 720x576 to 176x144 (50 Hz)	HD 720p
	D1 720x480 to 176x120 (60 Hz)	
Angle of view:	Horizontal: 47.0°-1.5°/ Vertical: 35.5°-1.1°	Fix: 84° dig. zoom
	> 100m	> 100m
Ingress Protection:	IP66	Outdoors IP 66
		Outdoors IP 54
Power:	PoE (Ethernet)	PoE (Ethernet)



AKVA Safe Guard provides a complete overview of the conditions around the cages and of the weather conditions in the local area.

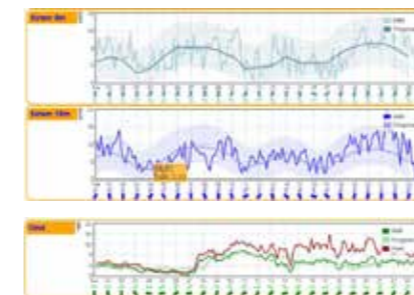

Detailed current and wind measurements with forecasts for the next three days, provides priceless information in real time.

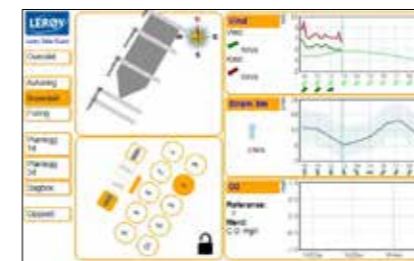

All recorded data and measurements are transferred to a data centre via a robust peer-to-peer network.



In challenging weather conditions, an anchoring on the wrong side of the cage could cause too much load and unnecessary damage on cages and moorings.

AKVA Safe Guard is a new and exciting collaboration between Lerøy Aurora, Multiconsult, NORUT, and AKVA group.

### Safer and more secure mooring of fish carriers at cages. Monitoring and decision support in a new, stand-alone system.

AKVA Safe Guard is a system for risk management (of operations and activities) and decision support that increases operational safety and prevents undesired incidents, such as broaching or personal injury. AKVA Safe Guard is based on monitoring parameters that can detect changes in the condition of the fish and the facility at an early stage, as well as the safety level during various operations. The parameters are input into diagnostic and forecast models that have been developed in collaboration with Norway's foremost consulting and university communities.

#### AKVA Safe Guard provides useful local information on:

- Environmental loads and loads from the fish carrier
- Observed loads on cables (continuous validation)
- Planning of ideal mooring points
- New and calculation-efficient model validated against full calculation models for vessels and fish farms
- New fish farm simulator with proprietary calculation model that simulates time for various systems of rope, chains, nets, buoys and large volume structures.



AKVA Safe Guard makes it easier and safer to anchor fish carriers at cages in challenging conditions.



AKVA Safe Guard sensor buoy.

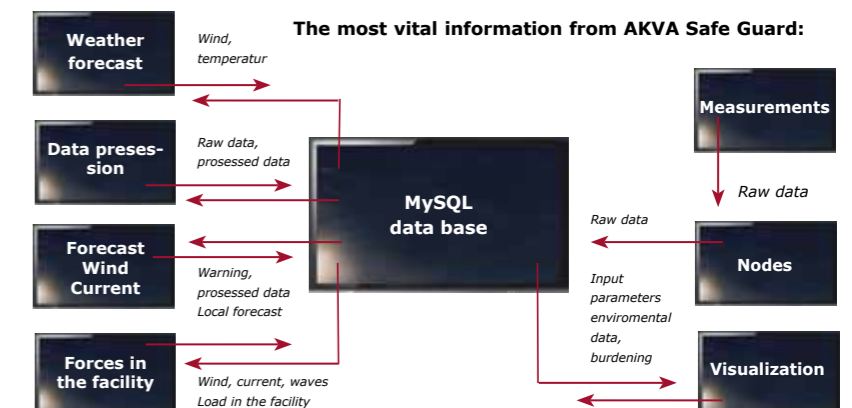

# Environmental Sensors



Environmental sensors are a smart investment that will ensure efficient feeding.

## Environmental data - a critical feeding parameter



Full control of the environmental data will ensure correct farming decisions.



Environmental sensors combined with AKVAconnect will monitor and control secure the stability in your system.

Feed accounts for 60-90% of the production cost in most fish farming today. That makes every pellet count when it comes to financial results.

To know the environmental data such as temperature, oxygen, salinity, pH and current speed and direction is important when feeding fish. Akvasmart Feeding Software allows full control of the environmental status on the site, at all times. The data can be viewed real-time or logged for later analysis. The Akvasmart software can also be set to automatically control the feeding based on these parameters.



Oxygen data - an important factor for growth and fish welfare.



A compact Multi Sensor with 6 different functions and 12 parameters including temperature and oxygen control.

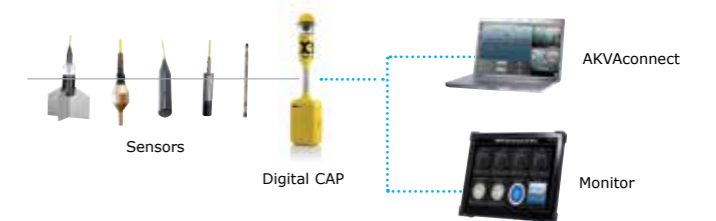
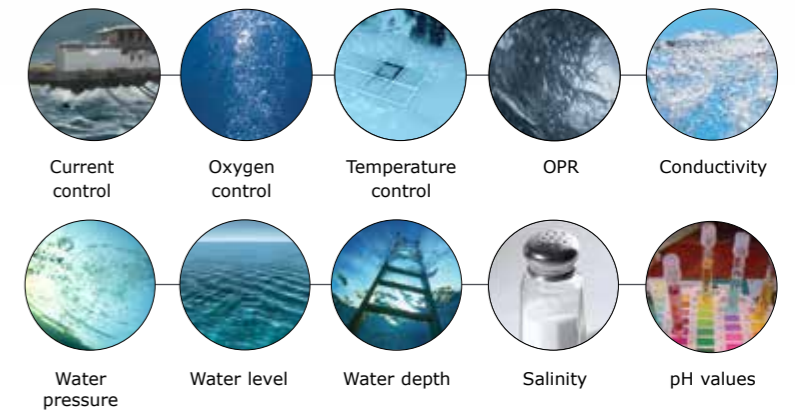

The current sensor system will prevent feed waste caused by tidal current pushing pellets out of the cage.



Temperature - the foundation for all feeding regimes and growth models.

## CAP - Wireless Sensor Network



## Transmission of video and sensor data

SENSORS

This wireless sensor network is an important integrated part of the Akvasmart CCS feed system. The CAP (Cage Access Point) has two-way data communication with the feed system and is an active part of AKVAconnect. Up to two underwater video cameras can be connected to each unit, in addition to the built-in surface camera and camera winch.

New Digital CAP features include more powerful transmitters, external channel selection, 360° adjustable surface camera and directional antennas. The CAP also allows for connection of temperature-, oxygen-, and current sensors. Video and sensor data are transmitted by wireless from each cage to the base.



*The CAP has a built-in surface camera for monitoring fish surface activity and feed spread even in difficult light conditions.*

The wireless sensor network is a useful and safe hub for all contact between the cages and the control room. A powerful pan/tilt/zoom camera can be controlled and moved into correct position from the control room on the feed barge. You can easily zoom in the area you want such as feed spread, net connections, a wellboat or the cage mooring.



*The new Winch V5 can be connected to the new Digital CAP.*



Built-in directional antenna and adjustable 360 degrees horizontal view.



Battery and cable connections are integrated in a splashproof compartment.



The CAP is userfriendly and easy to mount on cage handrails.

CAP	Smart CAP	Digital CAP
Built-in surface camera:	1 pcs.	1 pcs.
Resolution:	380 TV-lines	704x576
Light sensitivity:	0.2 Lux@F2.0 (Colour)	1.0Lux (Colour) - 0.3Lux (B/W)
Angle of view:	92°	360° Pan/tilt 12x700m
Frequency - video transmission:	-	5,8 GHz***
Frequency - command radio:	2,4 GHz***	-
Power supply:	12 - 24VDC / 230VAC*	12V / 230VAC*
Power consumption:	180 - 4900mA**	1-6A
Materials:	Aluminum/PC/Stainless Steel	Aluminum/PC/Stainless Steel
Size - Width x Height :	Ø280 x 770 (Ø10,9"x30,3")	Ø280 x 770 (Ø10,9"x30,3")
Weight:	7kg	12kg
Ethernet:	-	2 pcs. Phoenix connections
<b>Connections</b>		
Underwater Camera:	1 pcs.	1 pcs.
Temperature Sensor:	-	1 pcs.
Current Sensor:	-	1 pcs.
Oxygen Sensor:	-	1 pcs.
Camera Winch:	Smart Winch	Winch V5

\* Via separate AC adapter (extra) \*\* Depending on connected equipment  
 \*\*\* Frequencies can vary from country to country



Temperature Sensor

## Temperature - the foundation for feeding and growth models

There are two different temperature sensors: a separate sensor/stand-alone sensor for connecting to AKVAconnect or integrated in the optical oxygen sensor for using in AKVAconnect.



Oxygen Sensors

## Oxygen - an important factor for growth and fish welfare

The oxygen sensors are with optical reading which reduces the need of calibration and maintains high accuracy and operates with no drift over long-term deployments. On the Oxygen RDO all this information is stored in the replaceable CAP tip. The optical sensors have a fast response and maintains stability, even in dynamically changing conditions.



Current Sensor

## Environmental current knowledge prevent feed waste

An important parameter is the current or water flow when you feed but also to know your site. We can offer two types of current sensors, the Tilt sensor that gives current speed in one layer and the Doppler current profiler that gives you speed and direction at three different levels in the water column.



Multi Sensors  
3 or 5 parameters

## Full environmental overview - know your site

Measure and record water pressure, conductivity, and temperature with the Aqua TROLL 200, or conductivity and temperature with the Aqua TROLL 100. Unique conductivity cell allows for a wide, accurate measurement range in a narrow diameter instrument.



Multi Sensor  
12 parameters

The new Multi Sensor is a compact instrument that houses six water quality sensors and measures 12 parameters: • Actual and specific conductivity, salinity, total dissolved solids, resistivity, and density • Dissolved oxygen • ORP • pH • Temperature • Water level and water pressure (absolute).

Temperature Sensor	Separate	Inside
Resolution:	+/- 0.1° C	+/- 0.1° C
Accuracy:	+/- 0.5° C typical	+/- 0.1° C typical
Operating temp.:	0-50° C / 32-122°F	0-50° C / 32-122°F
Depth rating:	30m ltd. by cable	210m ltd. by cable
Housing:	Bronze	Polyethen
Cable:	30m urethane	30m urethane

Oxygen Sensors	RDO	Standard
Accuracy:	+/- 0.1mg/L 0-8mg/L +/- 0.2mg/L 8-20mg/L +/- 0.10% 20-50mg/L	+/- 0.1° C typical
Operating temp.:	0-50° C / 32-122°F	0-50° C / 32-122°F
Depth rating:	210m ltd. by cable	300m ltd. by cable
Housing:	Polyethen	Polyethen
Cable:	10 or 50m	10 or 50m

Current Sensor	0-50cm/sec	0-100cm/sec
Accuracy:	+/- 0.1cm/sec	+/- 0.2cm/sec
Measurement range:	0-50° C / 32-122°F	0-50° C / 32-122°F
Measuring principle:	Electronic tilt sensor	Electronic tilt sensor
Power consumption:	75mA	75mA
Depth rating:	Polyethen	PE/alu. or SS wings
Housing:	Acrylic/Pom/Alu.	Acrylic/Pom/Alu.
Cable:	30m Polyethen	30m Polyethen

Multi Sensors	Troll 100	Troll 200
Supported parameter:	Actual conductivity, specific conductivity, and temperature	Actual conductivity, specific conductivity, temperature, water depth/pressure
Conductivity:	+/- 0.5% +1uS/cm typical +/- 1% max range	
Temperature:	+/- 0.5° C	
Housing:	Titanium body and sensors, Delrin nose cone, and PVC conductivity cell	

Multi Sensor Troll 400	
Supported parameter:	Actual conductivity, specific conductivity, dissolved oxygen, pH, ORP, temperature, water level/depth/pressure (absolute)
Oxygen:	+/- 0.1mg/L 0-8mg/L +/- 0.2mg/L 8-20mg/L +/- 0.10% 20-50mg/L
Conductivity:	+/- 0.5% +1uS/cm typical +/- 1% max range
ORP:	+/- 0.5mV
pH:	+/- 0.1 pH unit
Temperature:	+/- 0.5° C
Housing:	PVC, acetal, titanium, 316 stainless steel



Digital CAP

Digital CAP UK

## Digital CAP UK - hardwired infrastructure for cameras and sensors

A connection point for all our underwater cameras and three environmental sensors. With transmission of up to 6 parallel video channels the system suits all types of farm sites. The Digital CAP UK is offered in two versions, a standard hardwired model and a new customized version with an Entry Level WI-Box for the Mediterranean market.

## Hard wired solutions - when simple stability counts

Infrastructure that fulfil your need for fixed solutions. Adapted and customized for each site - various sensors and cameras can be adapted to the system.



Wired EAP

## EAP - hard wired and wireless solutions for environmental data

The EAP is directly linked to the Akvsmart CCS Feed System via the AKVAconnect software. Collecting and logging environmental data from one or multiple depths provides better control of the feeding.



Environmental Sensor System

## Network for water quality and environmental data

All data can be viewed, recorded and logged within the AKVA connect software package, allowing parameter thresholds to be set and highlighted. The Akvsmart Environmental Sensor System is designed as a stand-alone system.



Power Cabinet

## Power Cabinet

CPU Power Cabinet supplies power to camera, winch, underwater light, CAP and other equipment on the cage. CPU are offered in two versions, one with 12QPD and one with 6QPD.

Digital CAP UK - Hardwired transmitter*	
Wired network:	Ethernet 100/1000Mbit - customized solutions, depended of site layouts and distances WI-FI Ethernet, Coax or fiber cables.
Above water camera:	External camera - Fix point as an option. 1. No Surface Camera 2. Cage site camera - 5m cable 3. Hamster Wheel camera - 30m cable
Under water:	All our models underwater cameras
Winch:	Option 1. N/A - 2. Standard and Winch HT
Sensors:	Optical Oxygen, Temperature, Current
Power supply:	Mains 230V

\* New Entry Level WI-Fi Box (1 or 2 servers) for the Mediterranean market.

EAP transmitter	Single	Triple
Temperature range:	-10°C to + 40°C	
Communication:	Wireless or hard wired	
Connections:	Amphenol plugs / direct terminal	
Materials:	Fibreglass/Acrylic/Aluminum	
Size - L x W x H:	370x300x170mm	560x560x170mm
Weight:	5kg	8kg
Sensor Connections		
Temperature:	1 pcs.	3 pcs.
Oxygen:	1 pcs.	3 pcs.
Current:	1 pcs.	3 pcs.
Accessories:	Protection aluminum housing (highly recommended) for installation on cage railings	

Environmental Sensor System	
Range:	+800m
Frequency:	868MHz (EU license free band)
Battery Size:	24Ah (if required)
Power supply:	115v-230v Single Phase. 12v model available on request
No. of Communications Hub per base:	50+
Sensors per Communications Hub:	3
Battery Life:	Minimum 24hours **
Mount Bracket:	Galvanised Steel/Stainless Steel
Sensor Cases:	Yellow

\*\* Requires optional UPS pack. Depends upon number of sensors and type of sensors attached.

Power Cabinet	
Power supply out:	220V, 50Hz
Power supply in:	40A, 400V, 50Hz
Weight:	25kg
Size without protection cover:	300x150x400mm
Material:	Polyethen
Ingress protection:	IP66

# Fish Farm Inspection System



## - rugged, portable feeding control

The Fish Farm Inspection System gives crystal clear video images from the submerged camera during feeding, and therefore provides a unique possibility to feed according to the fish appetite. The built-in battery gives the flexibility to use the system without any other infrastructure and the ruggedized system is built into a PELI-case.



Accurate fingertip control provides full overview of the cage in a few seconds, a smart and userfriendly solution.

The inspection system can easily be connected to Akvasmart cameras such as; SmartEye 360 Twin, Basic-HR and SuperHR. There is also an integrated Pan/Tilt controller for the SmartEye 360 Twin Camera.

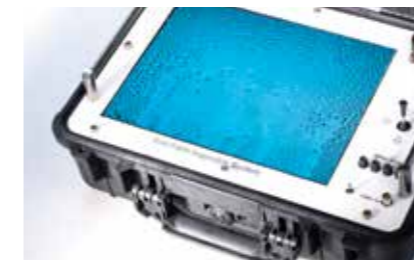

LCD screen made for rough, daily use and provides excellent readability in all light conditions.



A rugged, portable unit with internal battery and waterproof connection plugs.

## CAMERAS

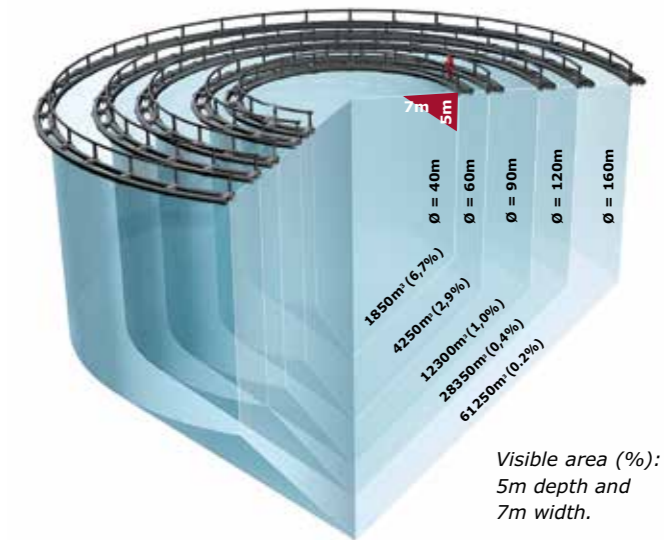

### Why use a camera to monitor feeding?

Cage sizes have rapidly increased over the last 20 years, and as a result, the visible area has decreased accordingly. In a cage of 160m circumference, only 0,2% is visible from the surface. Therefore a submersible camera is a requirement for monitoring and controlling feeding.



The Inspection System is tailor made for control of feeding and fish behavior, and can easily be connected to Akvasmart cameras like SmartEye, Super HR and Basic HR.



Fish Farm Inspection System	
Power supply:	230v AC
Power supply: (optional external battery)	12V DC
Power consumption:	30W * 230v AC - 400mA 12v DC - 2,75A
Internal battery capacity:	13Ah/12v DC 3 - 6 hours *
Sizes: (length/width/height - weight)	470mm x 350mm x 180mm - 10kg (18,3" x 14,3" x 7" - 22 lbs)
Ingress Protection. Lid closed:	IP68
Lid open:	IP65

\* Depending on connected equipment



## Measures length and height with high accuracy

The **Vicass HD (High Definition)** will provide farmers with accurate and efficient biomass estimation, taking high quality digital stereo images of the live fish swimming in the cage.

The images are analyzed in order to determine average weight of each fish. Vicass HD has high accuracy, capacity and speed and the camera unit captures 300-500 images at three different depths before they are analyzed.



The red graph is here showing calculated fish weight in different weight classes.



Accurate biomass estimation, taking high quality digital stereo images of the live fish while swimming in the cage or tank.



### New Vicass features:

- Possible to zoom images for exact data input.
- The weight distribution curve is continuously updated while fish is being entered/recorded by clicking.
- Measures fish sizes at a distance from 60cm up to 2m from the camera.
- Better image overlap because lenses on the new camera are located as little as 15cm apart.

### Vicass HD estimation

A stereoscopic video image measures the height and length of each fish. Advanced geometry algorithms accurately calculate the live weight of the fish.

### Models are now available for species like:

Atlantics, Chinook, Coho, Tasman Salmon, Rainbow Trout, Atlantic Haddock, Arctic Char, Red Sea Bream, Med. Sea Bass/Sea Bream, Striped Jack, Yellowtail, Japanese Amberjack, Nile Tilapia and Southern Blue Fin Tuna. Please ask us regarding other specie models.



### Biomass calculation for a wide range of species



Grabbing of images

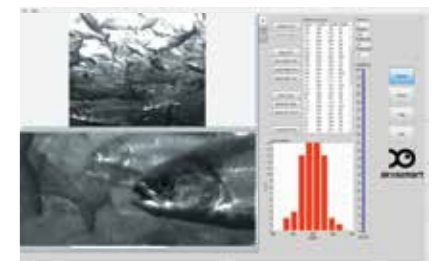

Analyzing

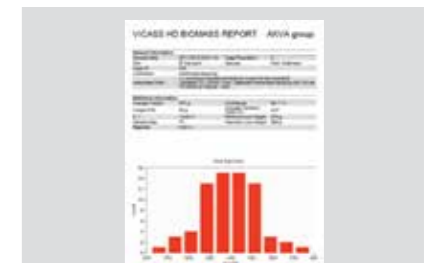

Reporting

Vicass HD	
Power supply:	220V (battery terminal for external battery)
Ingress protection:	Camera unit: IP68 Field computer lid open + plugs inserted: IP64 Field computer, lid closed: IP67
Camera size: length/width/height - weight:	515mm x 130mm x 195mm - 16kg
Field computer size: length/width/height - weight:	485mm x 392mm x 195mm - 12kg

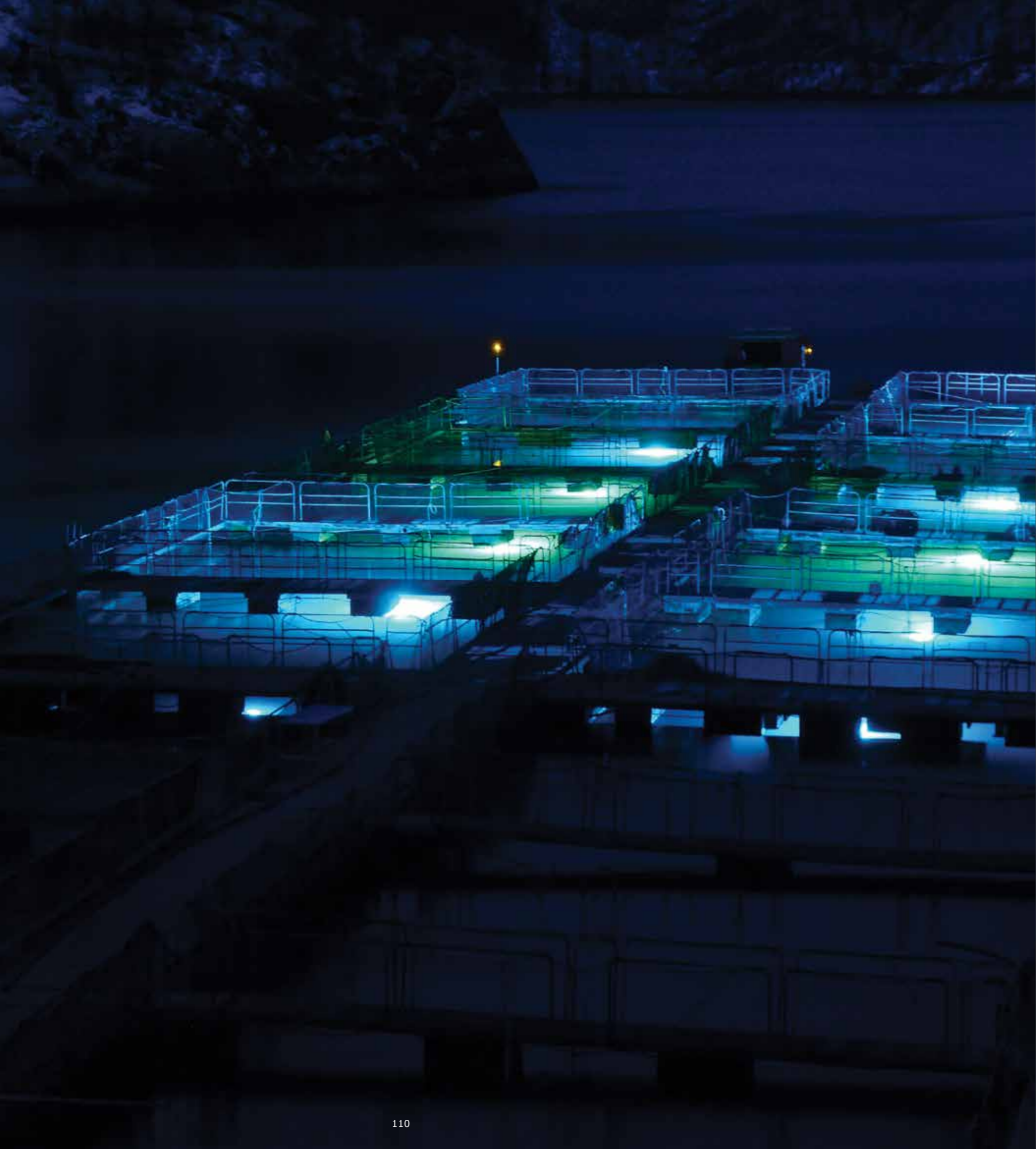

# Underwater Lights

## Stable and accurate lighting increases profits

The correct use of underwater lights for many aquaculture species, ensures reduced fish maturation. In addition it results in faster growth and more effective feed utilization. The Idema Underwater Lights series are adapted for smolt and juveniles in small tanks, as well as for salmon, cod and other fast growing species that require light in larger cage farms. The high quality underwater lights have excellent light distribution, the design allows for for easy bulb replacement, functional design and a rugged construction.

- Quality is always profitable.



# High quality underwater lights

■ Unique combination of ultraviolet, blue, green and white contrast light in one unit.



## LED underwater lights or metal halogen lights?

Expected life-span on the LED bulbs is in the region of 50.000 hours!



BlueLed 400W

ISO approved Pyro Borosilicate glass to withstand rough use in cage farming operations.

Standard 35m or 55m rugged underwater cable (urethane cable), and a waterproof connection plug.



SubLite 1000W

An extra strong construction that is almost maintenance free.

Attachment point for rope and cable.

Smooth surface and low weight reduces the risk of wear and tear and snagging.

Double O-ring protects the sealing.

Lens made in industrial acrylic.



UV-light

Two wires ensures better stability.

Seal gland with vulcanized cable entry.

Open metal core in aluminum bronze for optimal cooling and minimal fouling.

Blue/green LED-light (anti-maturation light)

White contrast light for excellent pellet detection.

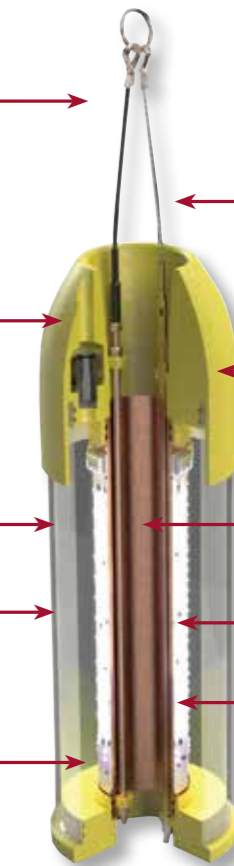

Aurora SubLed Combi 1350W



Aurora SubLED 1350 Combi keeps the fish in deeper waters most of the time and reduces louse pressure.

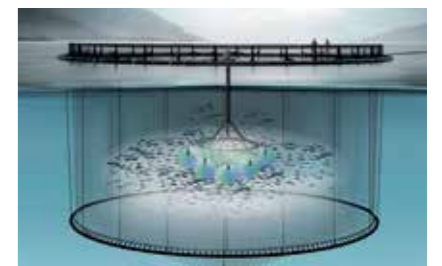

Underwater lights and subsea feeding will keep the fish in deeper waters around the feeding points most of the time.



Underwater Lights are a smart solution in Arctic areas where the light conditions are poor during winter time.



More than 16.000 Underwater Lights have been delivered world wide in the last 15 years.

## Bright solutions for tanks and cages

**Aurora SubLED Combi 1350W**, a new and unique combination of anti-maturation light and UV-light will keep the fish in deeper waters. The underwater lights are placed on approximately 10 meter depth and can then cover the whole cage. This will reduce the louse infestation and the effect will be reinforced if the light system can be combined with underwater feeding at the same depth. Recommended use: Medium and large cages.



**BlueLED 400W** with blue light rays is a rugged luminaire for the sea cages. This luminaire is utilizing the newest High Intensity LED-technology with almost four times more effective light source than the BlueLED 100W. The blue colour has proven to have a very good effect on the fish biology. LED luminaires can provide more effective output from each luminaire compared to other lamp technologies. It saves cost on power generators, less power use and uses less copper in the installations. All this in addition to the long service life of the luminaire.

Recommended use: Medium and large cages.



**Aurora SubLED 100W**, an adjustable underwater light for land based sites. In a standard version the light turns gradually on, but in a more advanced setting, the light in each tank can be controlled off and on after a predetermined program. This will reduce stress for the fish and ensure optimal smoltifaction. The light system has several benefits and it will not bring the fish up to the surface. Recommended use: Landbased tanks and smaller cages.

Recommended use: Landbased tanks and smaller cages.



**SubLite Integra 250W/400W** is the smallest member of the SubLite family. The light can be offered in two luminosities for smolt, juvenile and smaller locations. This model is often placed at various depths for a smooth distribution of light all over the cage. The light bulb and the electronic control device is integrated in the housing compartment and has a service time in the region of 5.000 hours. Recommended use: Tanks, smaller and medium cages.

Recommended use: Tanks, smaller and medium cages.



**SubLite Integra 1000W** is placed at various depths and the powerful light ensures an excellent spread. The light bulb and the electronic control device is integrated in the housing and is easy to install. This unit also has a service life in the region of 5.000 hours. Recommended use: Medium and large cages.

Recommended use: Medium and large cages.



## Underwater Lights Specifications



Specifications:	Aurora SubLed 1350W	BlueLed 400W	Aurora SubeLed 100W	Integra 250/400W	Integra 1000W
Operating voltage:	48 VDC	230 VAC 50Hz (60DC)	230 VAC/50Hz (24DC)	230 VAC 50Hz	230 VAC 50Hz
Starting current 0,5 second:	6,6A (1500W)	1,8A (400W)	1,0A (230W)	2,45A (563W) / 3,0A (690W)	8,0A (1840W)
Starting current 1 second:	6,6A (1500W)	1,8A (400W)	2,5A (115W)	1,9A (437W) / 2,0A (460W)	6,4A (1472W)
Operating current 2 min.:	6,05A (1350W)	2,15A (480W)	0,5A (106W)	1,3A (299W) / 1,8A (414W)	5A (1150W)
Total efficiency:	1350W	480W	115W	275W / 460W	1065W
Expected lifetime:	appr. 50 000 hours	appr. 70 000 hours	appr. 50 000 hours	appr. 5000 hours	appr. 5000 hours
Light source:	288 LED diodes / 32 UV diodes	184 LED	42 LED	HQI-T 250D / HQI-T 400D	HQI-T 1000D
Color temperature (Kelvin):	3000 K warm white	20000 K (480 nm Blue)	3000 K warm white	5300K / 6100K	6000K
Luminosity:	-	-	-	20 000 Im / 35 000 Im	85 000 Im
Weight, light housing:	6kg	11kg	8,5kg	7kg / 10kg	21,6kg
Size, length + Ø:	542mm + 160mm	641mm + 120mm	641mm + 120mm	648mm + 140mm	818mm + 180mm
Material in the main housing, density:	POM 1,41g/cm <sup>3</sup>	Aluminum 6082 T6 2,7g/cm <sup>3</sup>	POM 1,41g/cm <sup>3</sup> DIN 53479 - L15	POM 1,41g/cm <sup>3</sup> DIN 53479 - L15	POM 1,41g/cm <sup>3</sup> DIN 53479 - L15
Lence material:	Acrylic	Borosilicate glass	Borosilicate glass	Borosilicate glass	Borosilicate glass
Cable, standard lenght:	PUR 3G1,5 35 or 55 m	PUR 3G1,5 35m or 55m	PUR 3G1,5 35m or 55m	PUR 3G1,5 35m or 55m	PUR 3G2,5 35m or 55m
Cooling fluid:	Water (convection)	Silikon oil	Silikon oil	Water (convection)	Water (convection)
Recommended use:	Medium & large cages	Medium & large cages	Tanks /smaller cages	Tanks /med. & small cages	Medium & large cages

LED-light Halogen light

Note: Specifications are subject to change without prior notice.



We base our CE- marking on tests run by Nemko according to the EMC and LVD directives.

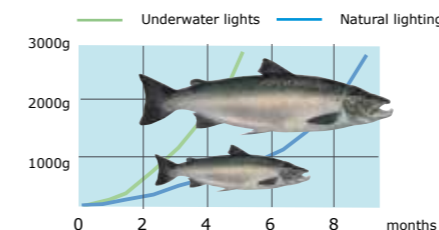

By using extra light on i.e. salmon, you will achieve faster growth and get higher harvest weight as opposed to not using underwater lights.



AKVA group offer a regular service visit with equipment control and maintenance, including a detailed status report.

Easy user interface allows you to set up your personal light regime in AKVAconnect. You can lit and turn off the lights for a fixed time. You can regulate the light intensity in each cage depending of the density of the fish and where you are in the production process. Our professional AKVA group staff can help you with the intial set up.



You can easily install the underwater lights at fixed depths and positions by using buoys and ropes.



## Production and process control software

### Intelligent IT solutions

AKVAconnect and Fishtalk are unique tools that integrate fish farming operations processing. This ensures optimum efficiency, excellent fish quality and increased profitability. The software covers all needs for process control, production control and planning.

**Fishtalk:** This software covers most aspects of the biological production control and planning, as well as production costing and budgeting. Reports and analysis are the basis for decisions, both long term and short term, and provides historical overview, status and prognosis.

**AKVAconnect:** A software platform that is designed for optimal control of the processes and activities on fish farms. The system offers full control, surveillance and integration of machines, sensors and all processes on both sea and land based fish farms.





### Fishtalk Control

Plan and finance, biology plan, finance - budgetting, economy control, production cost etc. Fishtalk Control captures data from broodstock to harvest and has powerful reporting and analysis capabilities. With the financial and planning modules Fishtalk becomes a primary tool, from day to day use on a single site to mapping out a 5-year plan for the whole company.

#### From broodstock to harvest

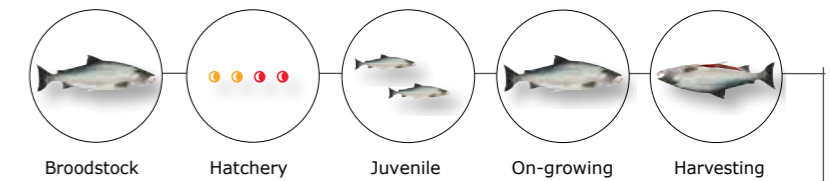

### AKVAconnect

AKVAconnect is a powerful "SCADA" process control platform used to connect and control a wide range of equipment and technical processes at the farm. The system is open ended and compatible with all types of equipment, sensors and technical installations. Smart 3D design with interactive control functions, makes it incredibly easy to operate.

#### Process control platform

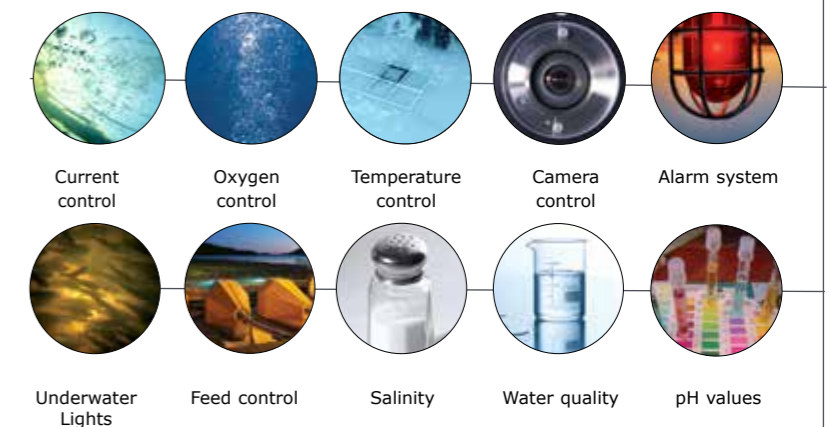

### Fishtalk Equipment

The Fishtalk Equipment software organizes all the farming equipment with documentation and maintenance, maintaining full traceability on component level. Comply with the Norwegian NS9415:2009 and NYTEK.

#### Full equipment control

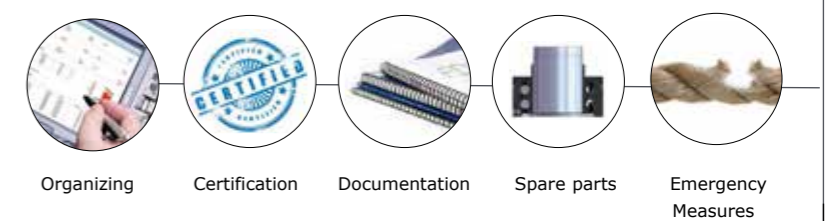

**AKVA Cloud solution provides simple access. The user can work off-line and all data will be visible on-line. Supports LTE/4G and Wi-Fi.**



## Production control and planning

■ **Dedicated software ensures safer and more cost effective solutions.**

## Fishtalk Control - from Broodstock to Harvest

SOFTWARE

### The Fishtalk-family

Fishtalk Control is developed with several modules, where the modules are the same system and don't require configuration of integrations. This provides benefits in terms of less risk of errors and reduced costs for setup, and one user interface to deal with.

In order to maintain as much control as possible and comprehensive management, we recommend expanding with Planning and Finance. This means all management data are in the same database that contains common functionality, and decisions may be made based on biology and economy. Biology and economy, historical, real-time and future are dimensions that walk hand in hand in Fishtalk. The reporting and analysis tools show the effect of all the areas in the same solution.

One of our newest modules is Fishtalk Optimizer, which allows users of Fishtalk Plan to optimize plans using optimization technology. Fishtalk Plan uses simulation to produce the biological plan, while Fishtalk Optimizer uses optimization techniques to identify the best plan.

Fishtalk Optimizer takes a plan and applies mathematical optimization to create the best possible slaughter plan based on a given set of restrictions. With Fishtalk Optimizer, planners will save time on planning and have the best slaughter plan calculated in a matter of seconds.

AKVA cloud will help to ensure better interaction between AKVA group's software solutions, while also facilitating communication with other developers of different types of software. We aim to make everyday life easier for our customers, and quite specifically this can entail that the fish farmer avoids having to punch data from the feed systems into Fishtalk, or that data from equipment inspections is registered in an app.

### Fishtalk Control

*Fishtalk Control software provides producers complete control of the production from broodstock to harvest. Used by single sites as well as large corporations, Fishtalk is the most complete production control software in the market.*

### Fishtalk Plan

*Fishtalk Plan is a user friendly tool for production planning. Yet it includes advanced features such as rolling forecasts, scenarios and flexible plan structures, making it a more powerful tool. The flexible reporting system helps you take operational decisions by comparing different scenarios efficiently.*

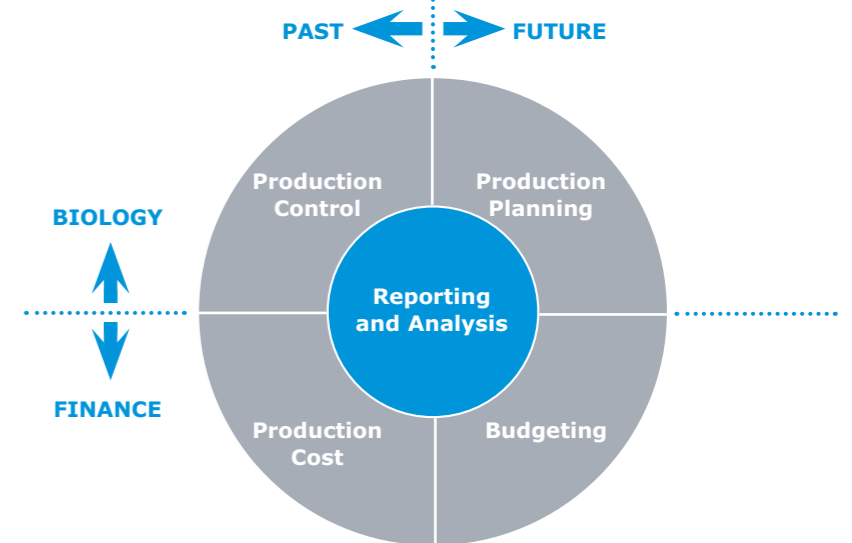

### Fishtalk Finance

*Production cost calculation is easy with Fishtalk Finance. A minimum of setup is required, and you will be up and running in no time. Simply import data from accounting once a month and you will easily obtain new insight into your cost of production.*

### Fishtalk Finance

*Budgeting using Fishtalk Finance is simpler than ever. Just define your cost models and any production plan can be used to generate the major cost factors like feed, transport and harvest. Comparing budgets generated from different scenarios quickly gives you the financial impact of your decisions.*



Fishtalk Control

# Fishtalk Equipment

Good operation of equipment is measured in biology – good biology results in good economy. Fishtalk Equipment is a good platform for improved operations and better control. Fishtalk Equipment is the solution for operation, maintenance and documentation, and can comprise all equipment at a location.

Tailored work processes for preventive maintenance. Plan, and receive notifications when the deadlines approach. Perform inspections with checklists for complete control of documentation.

Fishtalk has been developed in close cooperation with the industry to meet challenges in industrial fish farming.

**Organizes all the farming equipment with documentation and maintenance, maintaining full traceability.**

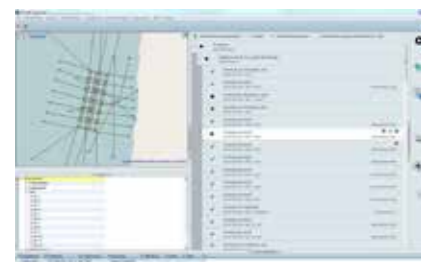

A graphical map view linked to list view makes it easy to maintain control of work orders for organizing activities, reports, overviews and document records.

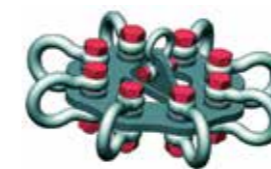
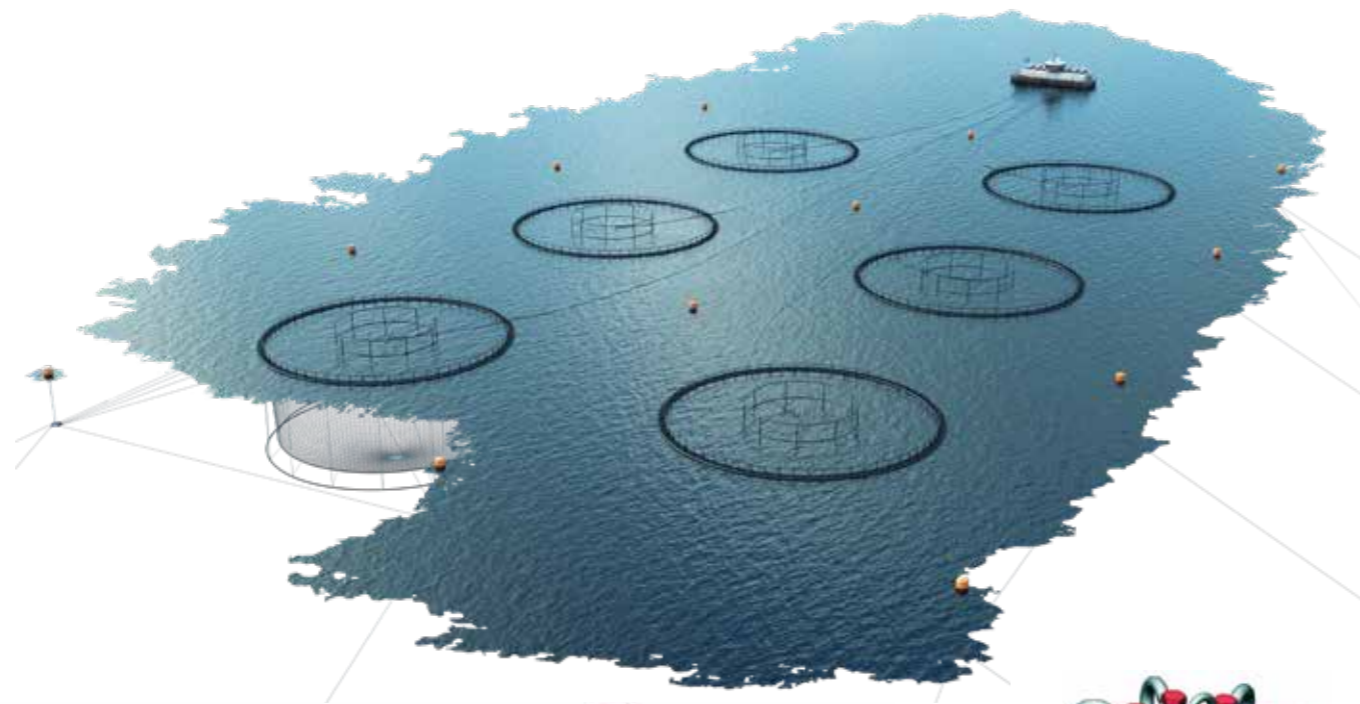

Fishtalk Equipment provides control and overview down to the smallest parts.

- Planning
- Preventive measures
- Quality
- Operations status
- Documentation
- Recertification
- Status of operations
- Status of maintenance
- Notification
- Work orders
- Certificates
- User guides

AKVA Cloud solution provides simple access. The user can work off-line and all data will be visible on-line. Supports LTE/4G and Wi-Fi.



## Recertification

Plans operation of equipment in relation to production cycle and time for next recertification. Plans notifications for the right time and to the right people. Documentation of recertification.



## Emergency measures

Map and table provides an overview of damaged parts and equipment. Provides all information in order to consider appropriate measures. Easily accessible information on strength/properties when parts need to be replaced quickly.

28.05.2014	
27.05.2014	AKVA
26.05.2014	AKVA
04.04.2014	
04.02.2014	AKVA
30.09.2013	
07.08.2013	AKVA
06.08.2013	

Predatorkontroll	
AKVA fish farm : Bur 1	
Kontroll av Stings	
AKVA fish farm : Bur 1	
Kontroll av info	
AKVA fish farm : Bur 1	
Predatorkontroll	

Dato	
26.02.2017	AKVA
11.01.2016	AKVA
11.01.2016	AKVA
17.08.2015	AKVA
13.08.2015	AKVA

- Assignment of tasks to user
- Help to user for performing tasks
- Direct input when job is being done
- Offline solution

Traceability with full history and access to all documentation, certificates and relevant user guides.

**Meets all requirements pursuant to NS 9415:2009 and NYTEK.**



## Biological planning

Operation of equipment must be adjusted to biological requirements. Good overview of status provides good basis to operate equipment based on biological plans. The right equipment in relation to wave height, current conditions, etc., and enough equipment available to satisfy needs.



## Audits

Documentation on operations and maintenance is always available. Information by component/equipment part, or at the level desired. Status of use and maintenance history. Overview of planned maintenance.

Serienummer: 4813	
Serienummer: 4597	
Serienummer: 4823	
Serienummer: 4823	

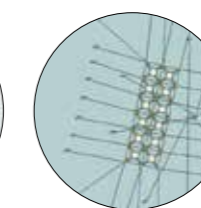

Avvik (1)	
Feil (1)	
Observasjoner / kom	
Legg til dokument	

# Fishtalk family – Flexible software for all fishfarmers



## Plan

Fishtalk Plan provides optimal production plans according to your strategies. This gives you a unique basis for making qualified operational decisions based on various scenarios for each species.



## Finance

Fishtalk Finance enables simulation of the financial effects of the planned activities. The solution provides in-depth information according to the biological plans, budgets and forecasts, - all based on a set of different scenarios.



## Optimizer

Fishtalk Optimizer uses mathematic optimization to create an optimal slaughtering plan including an ascertained set of limitations. Planners will be able to save time and calculate the best plan in seconds, using Fishtalk Optimizer.

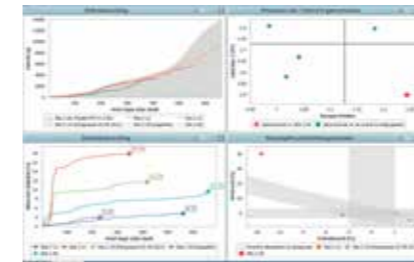

## Benchmarking

Fishtalk Benchmarking provides fast and simple rankings compared to established production goals, such as growth rates, feed conversion rates, hit rates and other KPIs as VF3 and SGR.

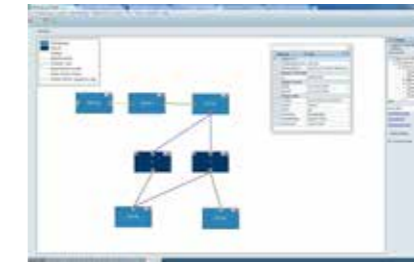

## Broodstock

Fishtalk Broodstock seamlessly integrates broodstock and production control, and provides full traceability to genetic origin and across generations of broodstock. It captures group level information as well as data for individual fish, like genetic markers and quality samples.

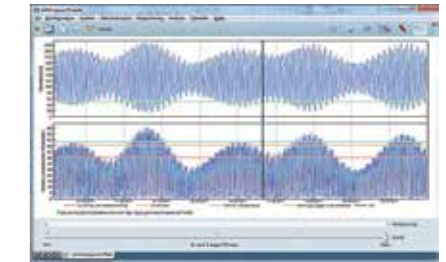

## Tide

Fishtalk Tide provides predicted hourly tide levels and change in tide level. This makes it easy to plan operations that depends on slack tide and low currents, like net change and lice treatments.

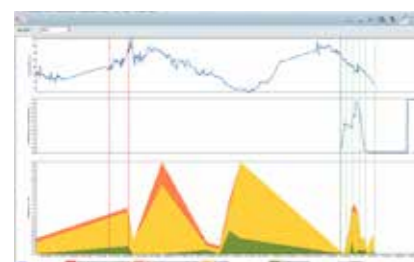

## Cleanerfish

Cleanerfish ensures a full updated overview of the treatment. The module extends the lice module in Fishtalk and provides an unique tool for monitoring and analysing.



## Lice

Fishtalk Lice shows lice developments and effect of treatments for each cage or region. Fishtalk Cleanerfish provides stocking numbers for each cage and percentage of Wrasse vs. salmon.

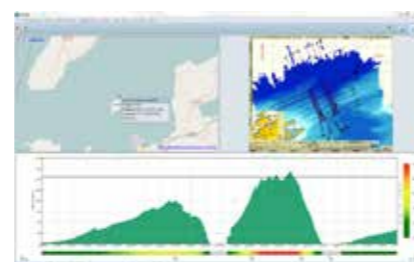

## Environmental Monitoring

Module for managing documents from environmental surveys. Enter results and documents from environmental surveys in Fishtalk. You can easily search, add or revise documents in a document archive.



## Equipment Service Planner

A system for boat communication, planning, assigning, executing and reporting for assignments related to service operations in aquaculture. The system comprises Planner, Boat manager and Tablet application.

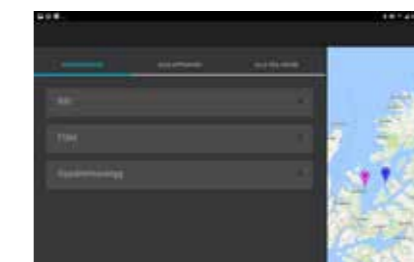

## WebClient and Apps

Efficient registration of data at the cage. Achieve better data flow, sharing and reporting. Get rid of the notepads and binders, and let our apps simplify collection of data from production. We supply both standard apps and customized solutions.



## Consulting

Vi have an expericed consultancy department with dedicated focus on biology and technology which will contribute to optimal results. From Fishtalk startup to customized courses and consulting, process improvement or tailormade software solutions.

# AKVAconnect Software



Safe Guard Sensor Buoy

AKVAconnect is a new process control platform used to connect to and keep control on everything from local farm sites to large international aquaculture corporations. The system is open ended and compatible with all types of equipment, sensors and technical installations. Smart 3D design with interactive control functions, makes it incredibly easy to operate.

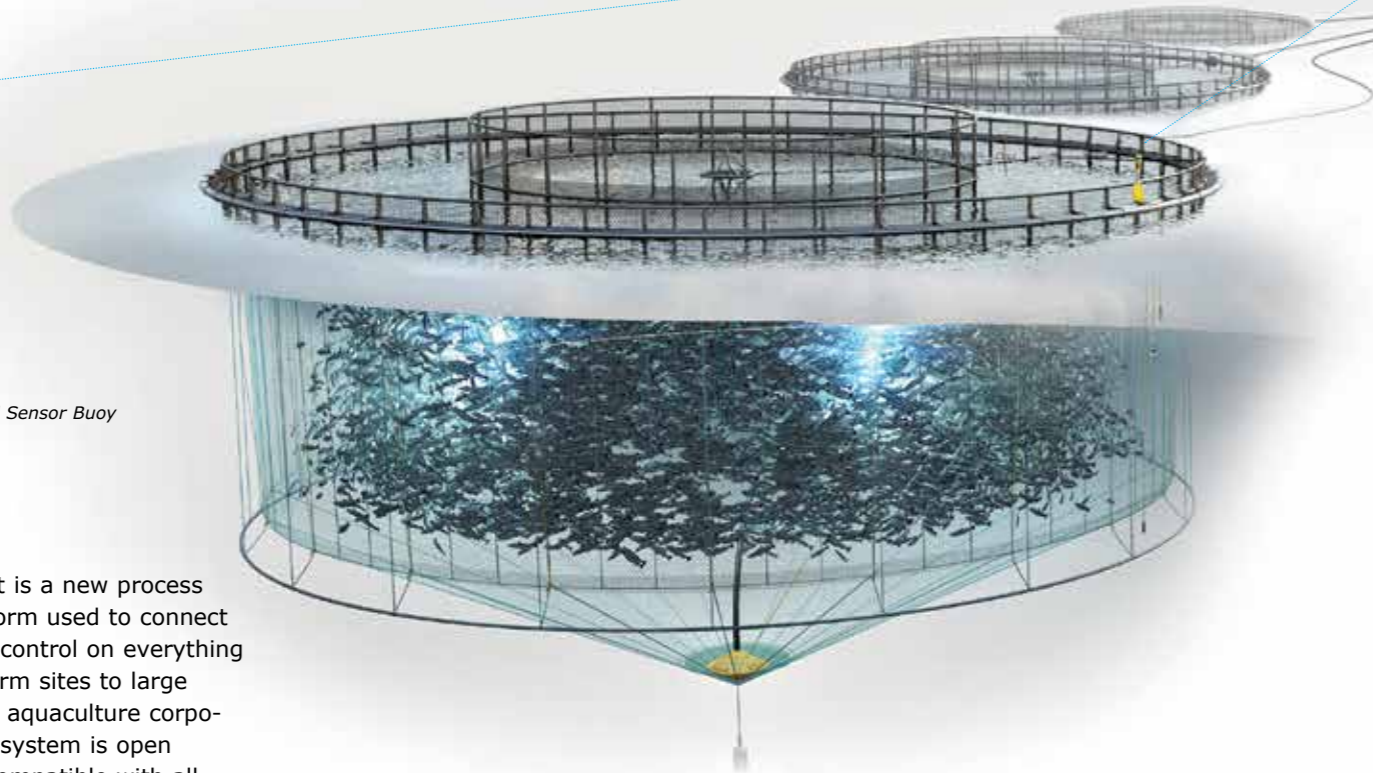

New smart control functions provides a complete barge and cage overview.



AKVAconnect is fully customizable, bringing forth exactly the information that the individual user needs.

AKVA Cloud solution provides simple access. The user can work off-line and all data will be visible on-line. Supports LTE/4G and Wi-Fi.



Digital CAP and Environmental Sensor System.

Feeding Camera.



Camera Control



Light Control



Environmental Control



Feeding Control



Process Control



Site Control

Achieve full access to the process on the farm via internet using a PC, iPad or a SmartPhone.

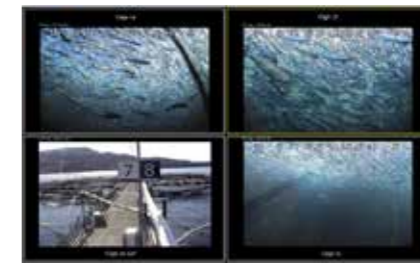

### Camera Control

Both analog and digital cameras are integrated in the system, and are fully controllable from any site or position. Multiple scalable camera windows can be shown and controlled directly on screen and monitored via internet.



### Environmental Control

Monitor and control all parameters in your production environment to secure maximum stability in your system. Temperature, oxygen, salinity, pH etc.



### Process Control

All devices can be monitored and controlled. Information about the present state, running hours and maintenance is conveniently monitored.

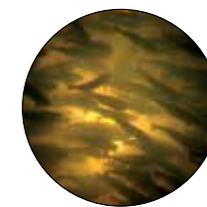

### Light Control

Large screens provides full overview and control the underwater lights in using AKVAconnect software. The lights can also be easily operated with remote control, using AKVA group's digital network.



### Feeding Control

AKVAconnect is a powerful and advanced software for daily control of all your feeding processes. Combined with Akvsmart CCS Feed System, it is the most adaptable and user friendly system on the market.



### Site Control

Site surveillance provides detailed information and status reports from multiple sites in real-time and is a very useful tool when you centralize the operations. AKVAconnect alarm system supports full traceability.

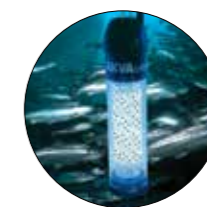
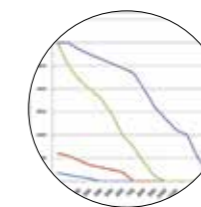



# Land Based Aquaculture

## Your partner in advanced water treatment technology

AKVA group has more than 40 years of aquaculture engineering experience. Our team of world leading experts is renowned for designing sustainable recirculation systems that are second to none. Having delivered systems globally for more than 20 different species, AKVA group provides optimal water quality conditions for both fresh- and seawater operations.

## Supplier of land based solutions for a wide range of species

A few years ago it was hard to imagine a supplier of complete land based aquaculture solutions. Today AKVA group steps into that role, with all the commitment and dedication it takes to become the preferred supplier-, maintenance-, service- and training partner for such companies worldwide. AKVA group's team of professionals have decades of experience supplying functional aquaculture technology to land based fish farming companies worldwide.

Your business will never be easier than this.



# From single components - to complete solutions



Feed System

Feeding Cameras

Underwater Lights

Environmental Sensors

Oxygen Cones

Sensor Network

Water Treatment Systems

RotorSpreaders



### Tank solutions

AKVA group tanks can be customized to any desired diameter and height thus making it possible to obtain perfect utilization of the available site space.



### Water treatment

AKVA group has 30 years experience providing optimal water quality conditions for both fresh- and seawater operations.



### Piping and pipework

AKVA group has one of the most modern production lines for polyethen pipes in Europe and thousands of kilometres have been delivered since 1971.



### Feeding systems

The Feed System will feed the correct amount, at the optimal rate, on time, every time.



### Sensor systems

Environmental sensor data is of vital importance. A better environment will always improve your production.



### Underwater Lights

Light treatment is successfully used for smolt and juveniles in tanks and cages of different types and sizes.

# From extensive to intensive water treatment

AKVA group offers a wide range of land based aquaculture technology, from single components to complete installations worldwide. The complete range of quality products and software provides maximum reliability and cost effectiveness.



Successfully spawned valuable species like sturgeon and tuna can reduce the pressure on wild stocks.

Unlike the short history of cage farming aquaculture, land based aquaculture goes back thousands of years with most of the production being fresh water farms in China and Asia.

Land based aquaculture is today one of the fastest growing food industries in the world. Although most of the industry was developed as extensive fish farming in ponds with low technology solutions, the main reason for today's growth is the increased use of intensive solutions and the latest innovations in water treatment technology. This makes it possible to maintain excellent water quality combined with exceptional low water- and energy consumption.

Over the last 20 years, energy consumption per kilo fish produced has been reduced by more than 80% while water recirculation has increased to more than 99%. In addition to freshwater, AKVA group also has unique knowledge in saltwater recirculation systems, making it feasible with profitable production of almost any species anywhere in the world. Our main success criteria include scientific competence, practical experience and close cooperation with both customers and research communities. This has enabled us to develop innovative and cost-effective solutions for most land based aquaculture projects.

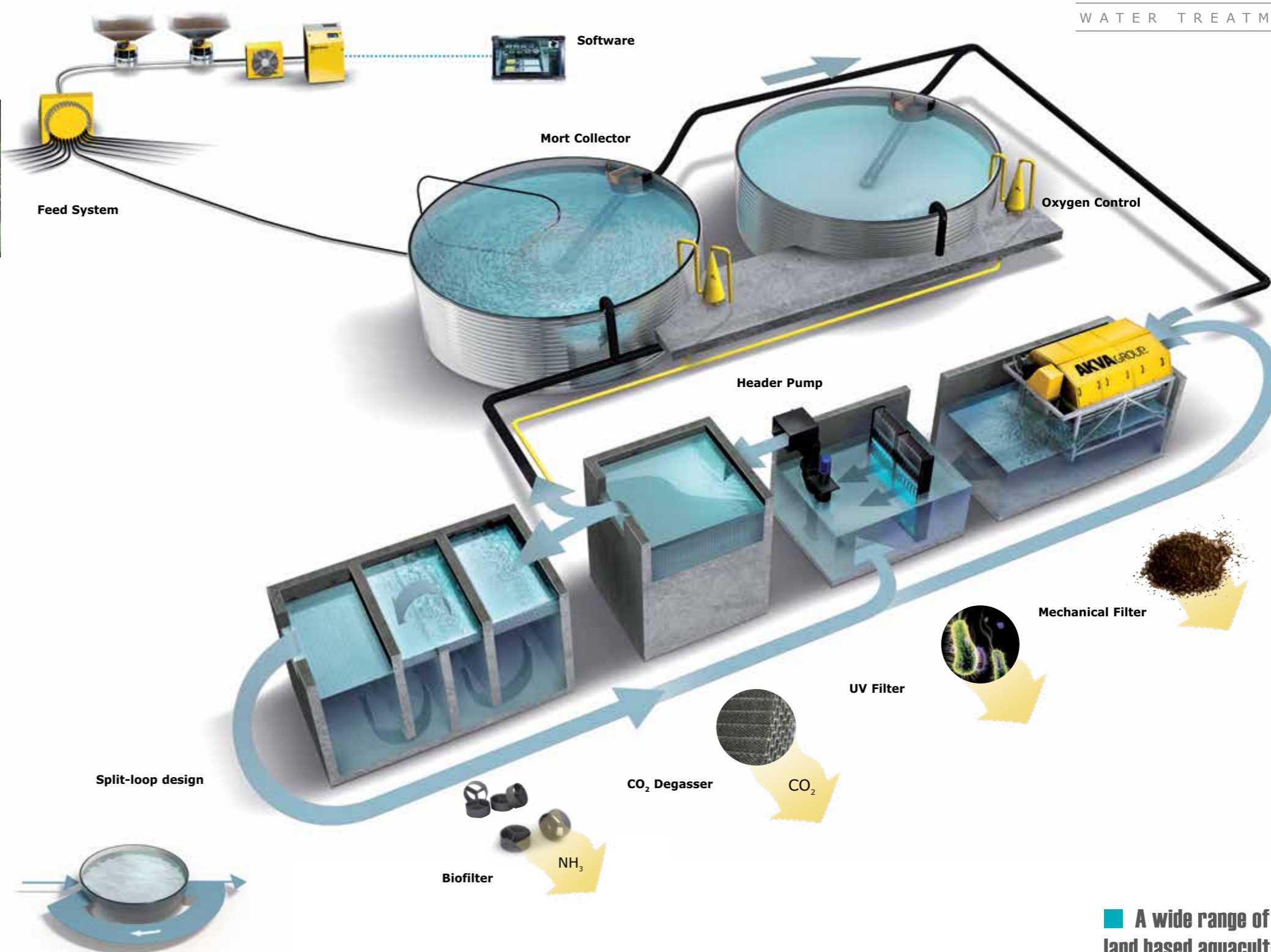

### Flow through system

The traditional form of landbased aquaculture with low level of water treatment technology. This form of aquaculture is commonly used on sites with vast amounts of water with a good temperature profile.



### Re-use system

Re-use is often a result of a gradual increasing implementation of technology including for instance oxygenation and degassing. Depending on the level of technology, the Re-use relative to flow-through is often between 20 and 60%.



### Recirculated system

Recirculation systems are currently being built all over the world and for many different species. A high level of technology allows a very high degree of water Re-use; normally in the range of 95-99% compared to the water consumption in a flow through system.

**A wide range of land based aquaculture solutions prepared for various species.**

For more information, order our Land Based Aquaculture Catalogue. [www.akvagroup.com](http://www.akvagroup.com)



# Dedicated aquaculture solutions

AKVA group offers tailor made solutions for a wide range of species both land based and cage farming aquaculture. Here 's some examples;



**Acipencer sp.**  
N: Star - GB: Sturgeon - ES: Esturión



**Rachycentron canadum**  
N: Cobia - GB: Cobia - ES: Cobia



**Pangasius sp.**  
N: Asiatick Malle - GB: Striped Catfish - ES: Basa

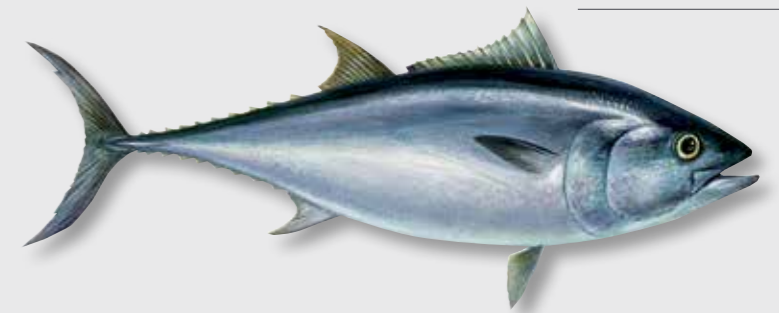

**Thunnus thynnus**  
N: Blåfinner Tunnfisk - GB: Bluefin Tuna - ES: Atún Aleta Azul



**Oncorhynchus mykiss**  
N: Regnbueørret - GB: Rainbow Trout - ES: Trucha Arco Iris



**Salmo salar**  
N: Laks - GB: Atlantic Salmon - ES: Salmón del Atlántico



**Oncorhynchus kisutch**  
N: Selvlaks - GB: Coho - ES: Salmón Coho



**Seriola sp.**  
N: Kingfish - GB: Amberjack/Kingfish - ES: Seriola sp.



**Dicentrarchus labrax**  
N: Europeisk Havabbor - GB: European Sea Bass - ES: Lubina



**Salvelinus alpinus**  
N: Røye - GB: Arctic Char - ES: Trucha Alpina



**Coregonus lavaretus**  
N: Sik - GB: Common Whitefish - ES: Lavareto



**Oncorhynchus tshawytscha**  
N: Kongelaks - GB: Chinook Salmon - ES: Salmón Rey



**Oreochromis niloticus**  
N: Nilmunruger - GB: Nile Tilapia - ES: Tilapia del Nilo



**Sparus aurata**  
N: Dorade - GB: Sea Bream - ES: Dorada



**Gadus morhua**  
N: Torsk - GB: Atlantic Cod - ES: Bacalao del Atlantico



**Lates calcarifer**  
N: Asiatick Havabbor - GB: Barramundi - ES: Perca Gigante



**Cyclopterus lumpus**  
N: Rognkjeks - GB: Lump sucker - ES: Lumpo



**Litopenaeus vannamei**  
N: Hvítforeke - GB: Whiteleg Shrimp - ES: Camarón blanco



**Ctenopharyngodon idella**  
N: Gresskarpe - GB: Grass Carp - ES: Carpa China



**Cyprinus sp.**  
N: Karpe - GB: Common Carp - ES: Carpa



**Sander lucioperca**  
N: Gjers - GB: Zander - ES: Lucioperca



**Labrus bergylta**  
N: Bergylte - GB: Ballan Wrasse - ES: Maragota



**Ctenolabrus rupestris**  
N: Bergnebb - GB: Goldsinny Wrasse - ES: Tabernero



**Penaeus monodon**  
N: Tigerreke - GB: Tiger Prawn - ES: Langostino Jumbo



**Hippoglossus hippoglossus**  
N: Kveite - GB: Halibut - ES: Halibut



**Psetta maxima**  
N: Piggvar - GB: Turbot - ES: Rodaballo



**Solea solea**  
N: Sjetunge - GB: Sole - ES: Lenguado



**Anarchicas minor**  
N: Flekksteinbit - GB: Catfish/Wolfish - ES: Perro del Norte



**Holothuria sp.**  
N: Sjøpølse - GB: Sea Cucumber - ES: Pepino del Mar

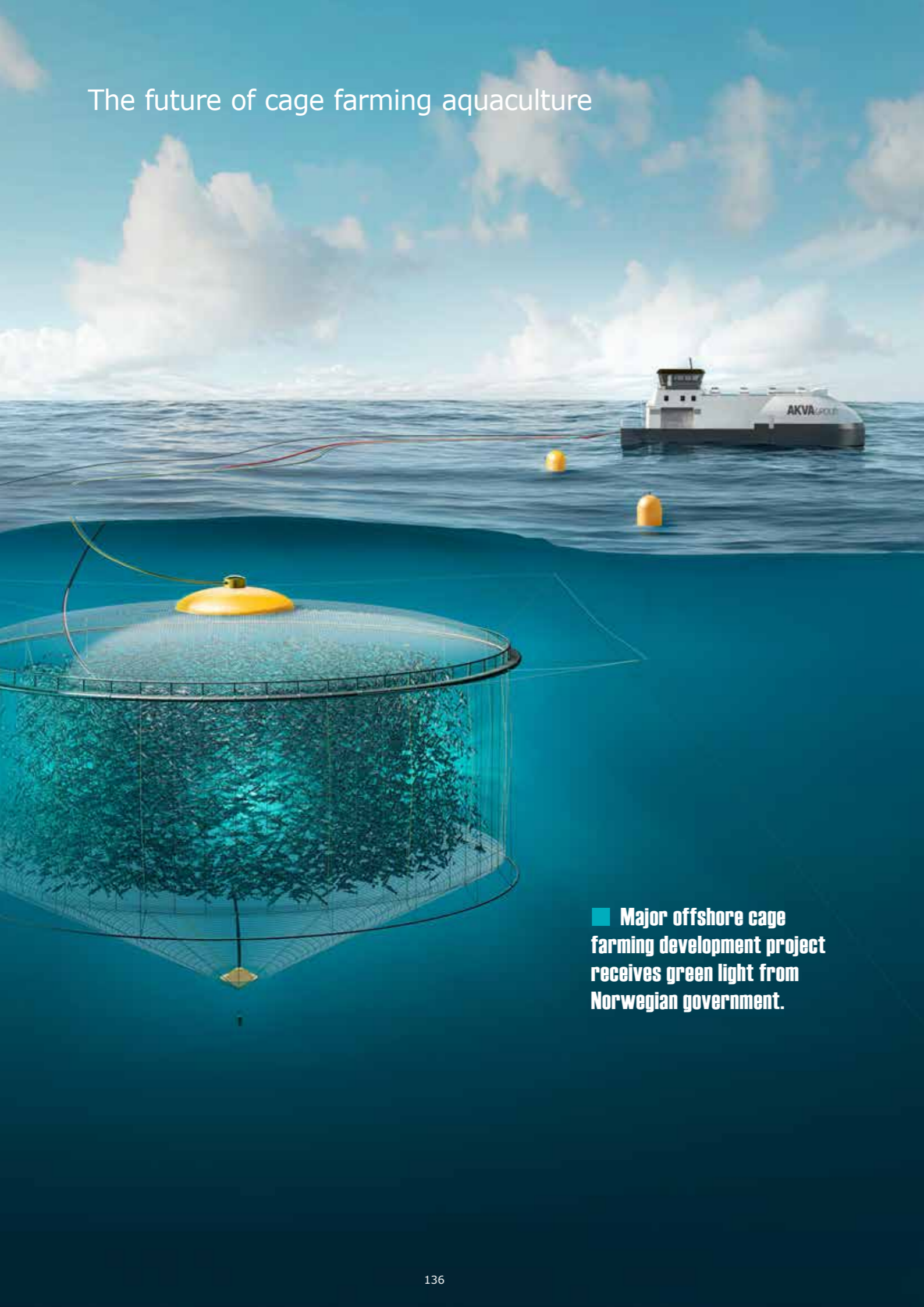

■ Major offshore cage farming development project receives green light from Norwegian government.

### Breakthrough for Atlantis

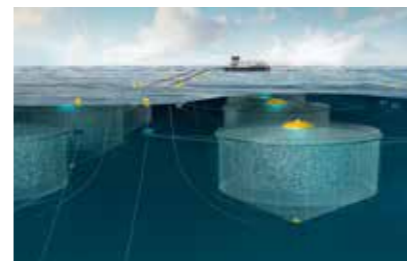

Atlantis Subsea Farming.

The Norwegian Department of Fisheries has informed Atlantis Subsea Farming that the application concept meets the criteria for the new development salmon licences in Norway.

In partnership with the companies Sinkaberg-Hansen AS and Egersund Net AS, AKVA group ASA has established the company Atlantis Subsea Farming AS with the purpose of developing submersible fish-farming facilities for salmon on an industrial scale.

### Extra stable feed barges with V-bottom



AC600 PVDB (Panorama double bow)

The new Wavemaster AC 600 PV with its new bow design, V-shaped hull and full keel, is truly designed for tough and exposed sites. The V-shaped hull increases stability as a larger area of the hull will be in contact with the water all the time. This will reduce rolling and the risk of the bottom of the hull being slammed by large waves.

The barge has a feed holding capacity of 635 tons in 8 silos, and thereby will not depend on frequent feed deliveries which can be a challenge on rough sites.

### "Like driving an underwater Mercedes"



The Flying Net Cleaner (FNC8)

New effective, gentle and remotely controlled washing rig from AKVA group and Sperre. The unique feature of the new cleaning rig is that it "swims" along the net line in the pen and cleans using high-pressure seawater. Nothing takes hold of the net that can damage and tear holes in it. This greatly reduces the risk of escape. Flying Net Cleaner is based on a patent pending principle that ensures that the rig is in balance regardless of whether it cleans horizontally, vertically or upside down. This makes it easier for the operator to select the cleaning direction that is most appropriate, regardless of which type of net one is dealing with.



Pilot chair

### 80 million tons by 2050

According to FAO projections, it is estimated that in order to maintain the current level of per capita consumption, global aquaculture production will need to reach 80 million tons by 2050.

(Source: FAO)

### New "magic" combination lamp



Aurora SubLED 1350 Combi keeps the salmon in deeper waters most of the time and reduces louse infestation.

Dimable Underwater Light - Unique combination of blue, green and ultraviolet LED light in one unit. AKVA group have in close cooperation with Norbit and leading fishfarming companies, developed a dimable underwater light with anti-maturation, contrast light and UV-light in on unit.

Use of blue and green LED-light will provide anti-maturation when it is necessary. In addition white light is used for maximum contrast between the salmon and the pellets during feeding. The UV-light is activated when it is important to keep the fish deeper in the cage to reduce the louse infestation, without disturbing any biological processes.

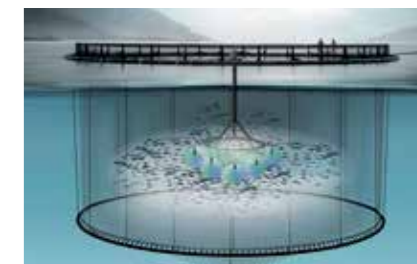

Underwater lights + subsea feeding will keep the salmon in deeper waters around the feeding points most of the time.

The underwater lights are placed on approximately 10 meter depth and can then cover the whole cage. This will reduce the louse infestation and the effect will be reinforced if the light system can be combined with underwater feeding on the same depth.

## EUROPE

 **NORWAY**  
AKVA group ASA - Bryne (Head Office)  
4340 Bryne, Norway  
**Telephone: 02582 (Norway only)**  
Telephone: +47 - 51 77 85 00  
E-mail: info@akvagrroup.com

AKVA group - Trondheim  
Ferjemannsveien 10, 7042 Trondheim, Norway  
Telephone: +47 - 51 77 85 00

AKVA group - Sandstad  
7246 Sandstad, Norway  
Telephone: +47 - 72 44 11 00

AKVA group - Mo i Rana  
Båsmosjyen 4, 8607 Mo i Rana, Norway  
Telephone: +47 - 75 00 66 30

Helgeland Plast AS - Mo i Rana  
Båsmosjyen 4, 8616 Mo i Rana, Norway  
Telephone: +47 - 75 14 37 50

Plastsveis AS - Berg  
8920 Sømna, Norway  
Telephone: +47 - 75 02 78 80  
www.plastsveis.no/post@plastsveis.no

AKVA group ASA - Tromsø  
Skippergata 41, 9008 Tromsø, Norway  
Telephone: +47 - 75 00 66 50

AKVA group - Oslo  
Stortingsgaten 8  
0161 Oslo, Norway  
Telephone: +47 - 51 77 85 00

Sperre AS - Notodden  
Merdeveien 1, 3676 Notodden, Norway  
Telephone: +47 35 02 50 00  
www.sperre-as.com

AKVA Marine Services - Torvastad  
Storesundvegen 141  
4260 Torvastad  
Telephone: +47 472 70 454 - 909 32 326

 **DENMARK**  
Aquatec Solutions as (Land based)  
Sadelmagervej 19  
DK-7100 Vejle, Denmark  
Telephone: +45 7588 0222  
aquatec@aq.s.dk

AKVA group Denmark AS (Land based)  
Roskildevej 342, Byg. 2  
DK-2630 Taastrup, Copenhagen, Denmark  
Telephone: +45 7551 3211

 **SWEDEN**  
AKVA group - Agent:  
Modus Trading AB, Färjegårdarne 7  
78461 Borlänge, Sweden  
Telephone: +46 - (0)243 883 22  
Fax: +46 - (0)243 21 17 78  
E-mail: modus@dalnet.se

 **ISLAND**  
AKVA group - Agent:  
Wise lausnir ehf.  
Borgartún 26, 105 Reykjavik, Iceland  
Wise lausnir ehf.,  
Hafnarstræti 102, 600 Akureyri, Iceland  
Telephone: +354 545 3200

 **UK (SCOTLAND)**  
AKVA group Scotland Ltd.  
36F Shore Street, Inverness  
Scotland, UK, IV1 1NF  
Telephone: +44 (0)1463 221 444  
Fax: +44 (0)1463 223 535

 **SPAIN**  
AKVA Group España tecnología  
de acuicultura S.L.  
C/Del Rocio, módulo A3,  
CP: 30820 Alcantarilla  
Murcia, Spain  
Telephone: +34 968 209 494

 **GREECE**  
AKVA group - Agent:  
Zellas Trading Company  
47 Achilleos Str. & Naiadon Str.  
Gr 17562 p. Faliro, Athens  
Telephone: +30 2107014881 - 2  
zellastrading@ath.forthnet.gr

 **TURKEY**  
AKVA group Kültür Balıkçılığı Ekipmanları  
Limited Şirketi  
Kemikler Mah.  
Güllük Güvençinlik Arası-2 Bulvar  
No:3/A, Milas / Turkey  
Telephone: +90 - 252-374-6434  
Fax: +90 - 252-374-6432

**For other European countries, please  
contact Head Office in Norway.**

## General Disclaimer

All specifications in this catalogue are subject to change without prior notice or obligation on the part of AKVA group. AKVA group shall not be held liable for possible errors in this catalogue. Product specifications, performance data, warranties and general terms and conditions of sale, must be described and verified in sales contracts. Local and regional product variations may apply.

## AMERICAS

 **CANADA**  
AKVA group North America Inc.  
1495 Baikie Road, Campbell River  
BC, V9W 0C2 Canada  
Telephone: +1 - 250-286-8802  
Fax: +1 - 250-286-8805

AKVA group North America  
240 Main Street,  
Upper Letang, NB  
E5C 3V1  
Telephone: +1 506 754 6991  
Fax: +1 - 250 286 8805

WiseDynamics Ltd  
5251 Duke Street, Suite 606,  
Duke Tower, Scotia Square  
Halifax, NS, B3J 1P3 Canada  
Telephone: +1-902-482-2663  
Fax: +1 - 902-405-3373

**For USA, please contact the office in Canada.**

 **CHILE**  
AKVA group  
Ruta 5 Sur Km. 1030, Puerto Montt, Chile  
Telephone: +56 - 65 2250250  
Fax: +56 - 65 2257119

**For other Latin American countries,  
please contact the office in Chile.**

## OCEANIA

 **AUSTRALIA**  
AKVA group Australasia Pty Ltd  
1st Floor 160 Collins Street  
Hobart Tas 7000  
GPO Box 1083 Hobart Tas 7001  
Telephone: +61 400 167 188  
Mobile: +56 968 344 794

## ASIA

 **IRAN**  
AKVA group, Qeshm Island  
Teheran Office:  
No 403, Sarv Saee building, Valiasr Street  
Teheran, Iran  
Telephone: +98-2188722211

**For other Asian countries, please  
contact Head Office in Norway.**

## AFRICA

 **TUNISIA**  
AKVA group - Agent:  
Société Méditerranéenne d' Etudes et Conseils  
72, Avenue Habib Bourguiba, 2080 Ariana, Tunisie  
Telephone: +216 71 700 453  
Fax: +216 71 700 297  
Email: smechg@gnet.tn

**For other African countries, please  
contact Head Office in Norway.**